



Mounting

Connection

Application examples

Operation

Troubleshooting



11202214

**Thank you for buying this product.
Read this manual carefully to get the best performance from this unit.
Please keep this manual carefully.**

en

Manual

Contents

Overview	3	System layout 8.....	24
1. Installation	4	System-specific functions.....	26
1.1 Mounting	4	System layout 9.....	28
1.2 Electrical connection.....	4	System layout 10	30
1.3 Terminal allocation in the different system layouts	6	2. Operation and function	32
System layout 1.....	6	2.1 Push buttons.....	32
System layout 2.....	8	2.2 System-Monitoring-Display	32
System-specific functions.....	10	2.3 Flashing codes	33
System layout 3.....	12	3. Commissioning	34
System-specific functions.....	14	4. Channel overview	37
System layout 4.....	16	4.1 Display channels	37
System layout 5.....	18	4.2 Adjustment channels.....	39
System layout 6.....	20	5. Troubleshooting	47
System layout 7.....	22	5.1 Various.....	48

Safety advice

Please pay attention to:

- safety advice in order to avoid danger and damage to people and property.
- the valid local standards, regulations and directives!

Description of symbols

WARNING!	Warnings are indicated with a warning triangle!
	They contain information on how to avoid the danger described.

Signal words describe the danger that may occur, when it is not avoided.

WARNING means that injury, possibly life-threatening injury, can occur.

ATTENTION means that damage to the appliance can occur.



Note

Notes are indicated with an information symbol.

→ Arrows indicate instruction steps that should be carried out.

Disposal

Dispose of the packaging in an environmentally sound manner.

Dispose of old appliances in an environmentally sound manner. Upon request we will take back your old appliances bought from us and guarantee an environmentally sound disposal of the devices.

Target group

These instructions are exclusively addressed to authorised skilled personnel.

Only qualified electricians should carry out electrical works.

Initial installation must be effected by qualified personnel named by the manufacturer.

Information about the product

Proper usage

The solar controller is designed for use in solar thermal and heating systems in compliance with the technical data specified in these instructions.

Improper use excludes all liability claims.

CE-Declaration of conformity

The product complies with the relevant directives and is therefore labelled with the CE mark. The Declaration of Conformity is available upon request, please contact the manufacturer.



Note

Strong electromagnetic fields can impair the function of the controller.

→ Make sure the controller as well as the system are not exposed to strong electromagnetic fields.

Subject to technical change. Errors excepted.

Overview

- System-monitoring-display
- Up to 4 Pt1000 temperature sensors
- 2 semiconductor relays for pump speed control
- 10 basic system layouts to choose from
- Heat quantity measurement
- Function control
- Thermostat function (time-controlled)
- Control of the system by ServiceCenter software possible
- User-friendly operation
- Housing with outstanding design
- Extra-low power consumption
- HE pump control via adapter



Included with the BS Plus:

- 1 × Controller
- 1 × accessory bag
 - 1 × spare fuse T4A
 - 2 × screws and wall plugs
 - 4 × strain relief and screws
- 1 × manual

Additionally enclosed in the full kit:

- 2 × sensor FKP6
- 2 × sensor FRP6

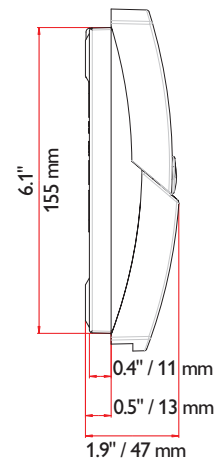
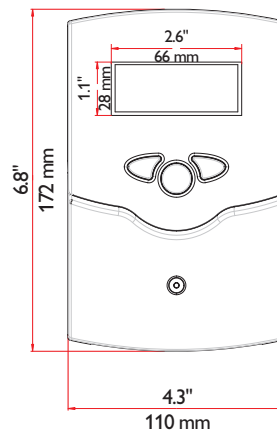

Technical data

Housing: plastic, PC-ABS and PMMA

Protection type: IP 20 / EN 60529

Ambient temp.:
0 ... 40 °C [32 ... 104 °F]

Size:
172 × 110 × 46 mm
6.8" × 4.3" × 1.9"

Mounting: wall mounting, mounting into patch-panels is possible

Display: System screen for system visualisation, 16-segment display, 7-segment display, 8 symbols for system status and operating control lamp

Operation: by 3 push buttons at the front of the housing

Functions: Differential temperature controller with optional add-on system functions. Function control, operating hours counter for solar pump, tube collector function, pump speed control, thermostat function, drainback and booster option, and heat quantity measurement.

Inputs: for 4 Pt1000 temperature sensors

Outputs: 2 semiconductor relays

Bus: VBus®

Power supply: 100 ... 240 V~

Standby power consumption:
< 1 W

Switching capacities:
R1: 1 (1) A 100 ... 240 V~
(semiconductor relay)
R2: 1 (1) A 100 ... 240 V~
(semiconductor relay)

1. Installation

1.1 Mounting

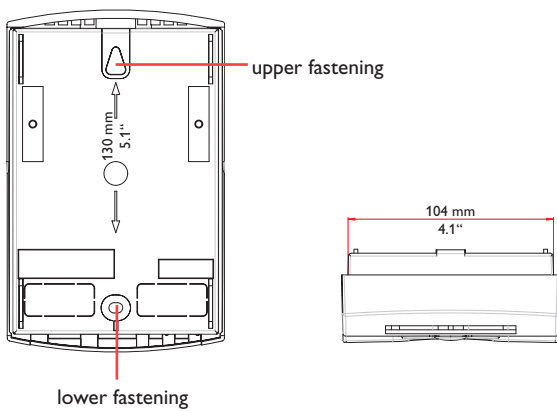
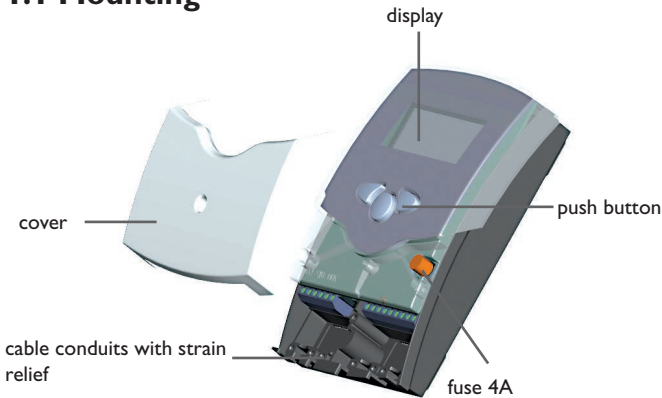

WARNING!	Electric shock!
	Opening the housing will expose live parts!
	→ Switch off power supply and disconnect the device from power supply before opening the housing!

- The unit must only be installed
- in a dry interior location
 - in a non-hazardous location
 - away from electromagnetic fields

The controller must additionally be supplied from a double-pole switch with contact gap of at least 3 mm [0.12"].

- Route sensor cables and power supply cables separately.
- Unscrew the cross-head screw from the cover and remove it along with the cover from the housing
 - Mark the upper fastening point on the wall and drill
 - Fasten the enclosed wall plug and screw leaving the head protruding
 - Hang the housing from the upper fastening point and mark the lower fastening point through the hole in the terminal box (centers 130 mm [5.1"])
 - Drill and insert the lower wall plug
 - Fasten the housing to the wall with lower fastening screw and tighten
 - Complete wiring connections in accordance with terminal allocations, see chap. 1.2 "Electrical connection"
 - Place the cover back onto the housing
 - Fasten the cover by means of the cross-head screw

1.2 Electrical connection

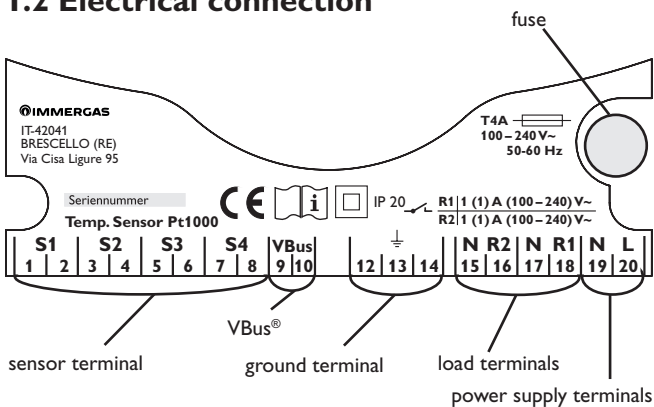

ATTENTION!	ESD damage!
	Electrostatic discharge can lead to damage to electronic components!
	→ Take care to discharge properly before touching the inside of the device. To do so, touch a grounded surface such as a radiator or tap!

Note:
The minimum pump speed must be set to 100% when auxiliary relays or valves are connected.



Note:

Connecting the device to the mains supply must always be the last step of the installation! The power supply to the controller must be carried out via an external power switch (last step!).

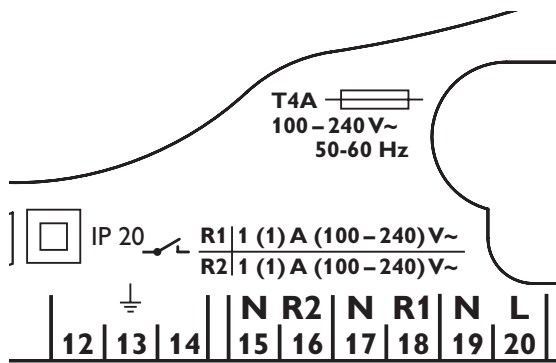

Grounding and load terminals

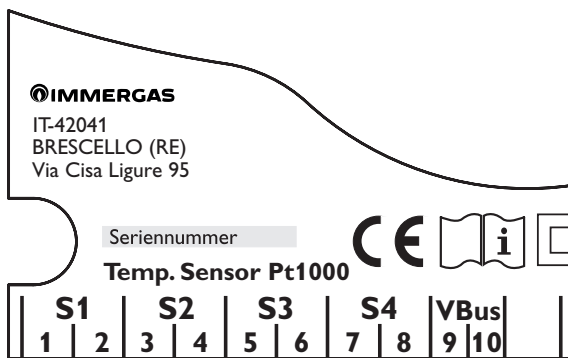

Sensor terminals S1 ... S4

The supply voltage must be 100 ... 240 V~ (50 ... 60 Hz). Flexible cables must be attached to the housing with the enclosed strain relief and the corresponding screws.

The controller is equipped with two semiconductor relays, to which **loads** such as pumps, valves etc. can be connected:

- **Relay 1**
 - 18 = conductor R1
 - 17 = neutral conductor N
 - 13 = ground conductor
- **Relay 2**
 - 16 = conductor R2
 - 15 = neutral conductor N
 - 14 = ground conductor

The **mains supply** is to be carried out at the terminals:

- 19 = neutral conductor N
- 20 = conductor L
- 12 = ground terminal

The **temperature sensors** (S1 up to S4) are to be connected to the following terminals with either polarity:

- 1 / 2 = Sensor 1 (e.g. Sensor collector 1)
- 3 / 4 = Sensor 2 (e.g. Sensor store 1)
- 5 / 6 = Sensor 3 (e.g. Sensor store top)
- 7 / 8 = Sensor 4 (e.g. Sensor return)

All Pt1000 temperature sensors are equipped with a platinum measuring element in their tip. The electrical resistance of the measuring element changes in relation to the temperature (see table in chap. 5).

The difference between **FKP** and **FRP** type sensors only lies in the cable insulation material. The insulation material of FKP type sensor cables resists a higher temperature, so that FKP type sensors should be used as collector sensors. FRP type sensors are best used as reference sensors in stores or pipes.

1.3 Terminal allocation in the different system layouts

System layout 1

The controller calculates the temperature difference between collector sensor S1 and store sensor S2. If the difference is larger than or identical to the adjusted switch-on temperature difference (DT O), the solar pump will be operated by relay 1, and the store will be loaded until the switch-off temperature difference (DT F) or the maximum store temperature (S MX) is reached.

Sensors S3 and S4 can optionally be connected for measurement purposes. S3 can optionally be used as reference sensor for the store emergency shutdown option (OSEM). If heat quantity measurement (OHQM) is activated, sensor S4 has to be connected as return sensor.

If the drainback option (ODB) is activated, relay 2 can be used to operate a booster pump by activating the booster function (OBST).

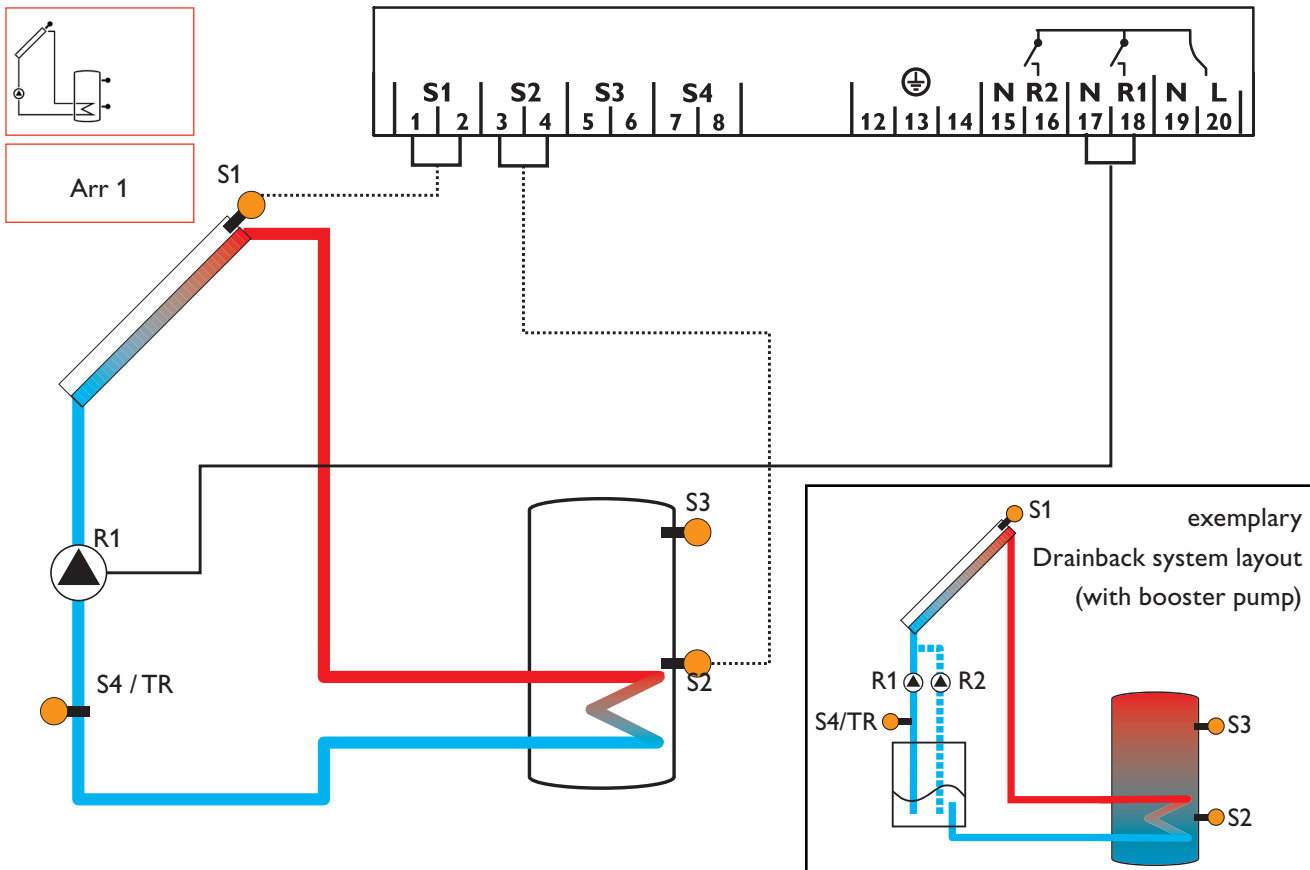

Display Channels				
Channel		Description	Terminal	Page
INIT	x*	ODB initialisation active	-	37
FLL	x*	ODB filling time active	-	37
STAB	x*	ODB stabilisation in progress	-	37
COL	x	Temperature collector	S1	37
TST	x	Temperature store	S2	37
S3	x	Temperature sensor 3	S3	37
TSTT	x*	Temperatur store at the top	S3	37
S4	x	Temperature sensor 4	S4	37
TR	x*	Temperature return sensor	S4	37
n %	x	Pump speed R1	R1	38
hP	x	Operating hours R1	R1	38
hP1	x*	Operating hours R1 (if OBST is activated)	R1	38
hP2	x*	Operating hours R2 (if OBST is activated)	R2	38
kWh	x*	Heat quantity kWh	-	38
MWh	x*	Heat quantity MWh	-	38
TIME	x	Time	-	34

Adjustment Channels				
Channel		Description	Factory setting	Page
Arr	x	System	1	39
DT O	x	Switch-on temperature difference	6.0 K [12.0 °Ra]	39
DT F	x	Switch-off temperature difference	4.0 K [8.0 °Ra]	39
DT S	x	Nominal temperature difference	10.0 K [20.0 °Ra]	39
RIS	x	Rise control R1	2 K [4 °Ra]	39
nMN	x	Minimum pump speed	30 %	39
S MX	x	Maximum store temperature	80 °C [176 °F]	40
OSEM	x	Option store emergency shutdown	OFF	40
EM	x	Emergency temperature collector	130 °C [270 °F]	40
		Emergency temperature collector if ODB is activated:	95 °C [200 °F]	40
OCC	x	Option collector cooling	OFF	41
CMX	x*	Maximum collector temperature	110 °C [230 °F]	41
OSYC	x	Option system cooling	OFF	41
DTCO	x*	Cooling switch-on temperature difference	20.0 K [40.0 °Ra]	41
DTCF	x*	Cooling switch-off temperature difference	15.0 K [30.0 °Ra]	41
OSTC	x	Option store cooling	OFF	42
OHOL	x*	Option holiday cooling	OFF	42
THOL	x*	Holiday cooling temperature	40 °C [110 °F]	42
OCN	x	Option minimum limitation	OFF	42
CMN	x*	Minimum collector temperature	10 °C [50 °F]	42
OCF	x	Option antifreeze	OFF	42
CFR	x*	Antifreeze temperature	4.0 °C [40.0 °F]	42
OTC	x	Option tube collector	OFF	44
TCST	x*	OTC starting time	07:00	44
TCEN	x*	OTC ending time	19:00	44
TCRU	x*	OTC runtime	30 s	44
TCIN	x*	OTC standstill interval	30 min	44
OHQM	x	Option heat quantity measurement	OFF	44
FMAX	x*	Maximum flow	2.0 l	44
MEDT	x*	Antifreeze type	1	44
MED%	x*	Antifreeze concentration (only if MEDT = propylene or ethylene)	45 %	44
ODB	x	Drainback option	OFF	45
tDTO	x*	ODB switch-on condition - time period	60 s	45
tFLL	x*	ODB filling time	5.0 min	45
tSTB	x*	ODB stabilisation time	2.0 min	45
OBST	s*	Option booster function	OFF	45
MAN1	x	Manual operation R1	Auto	46
MAN2	x	Manual operation R2	Auto	46
ADA1	x	HE pump control	OFF	46
LANG	x	Language	En	46
UNIT	x	Temperature unit	°C	46
RESE	x	Reset - back to factory settings		46
W005#####		Version number		

Legend:

Symbol	Specification
x	Channel is available
x*	Channel is available if the corresponding option is activated.
s*	System-specific channel, only available if the corresponding option is activated

System layout 2

The controller calculates the temperature difference between collector sensor S1 and store sensor S2. If the difference is larger than or identical to the adjusted switch-on temperature difference (DT O), the solar pump will be operated by relay 1, and the store will be loaded until the switch-off temperature difference (DT F) or the maximum store temperature (S MX) is reached.

Heat exchange from store 1 to store 2 will be operated by relay 2, if the temperature difference between sensors S3 and S4 is larger than or identical to the adjusted switch-on temperature difference (DT3O), until the adjusted minimum (MN3O) and maximum (MX3O) temperature thresholds of the respective stores are reached. S3 can optionally be used as reference sensor for the store emergency shutdown option (OSEM).

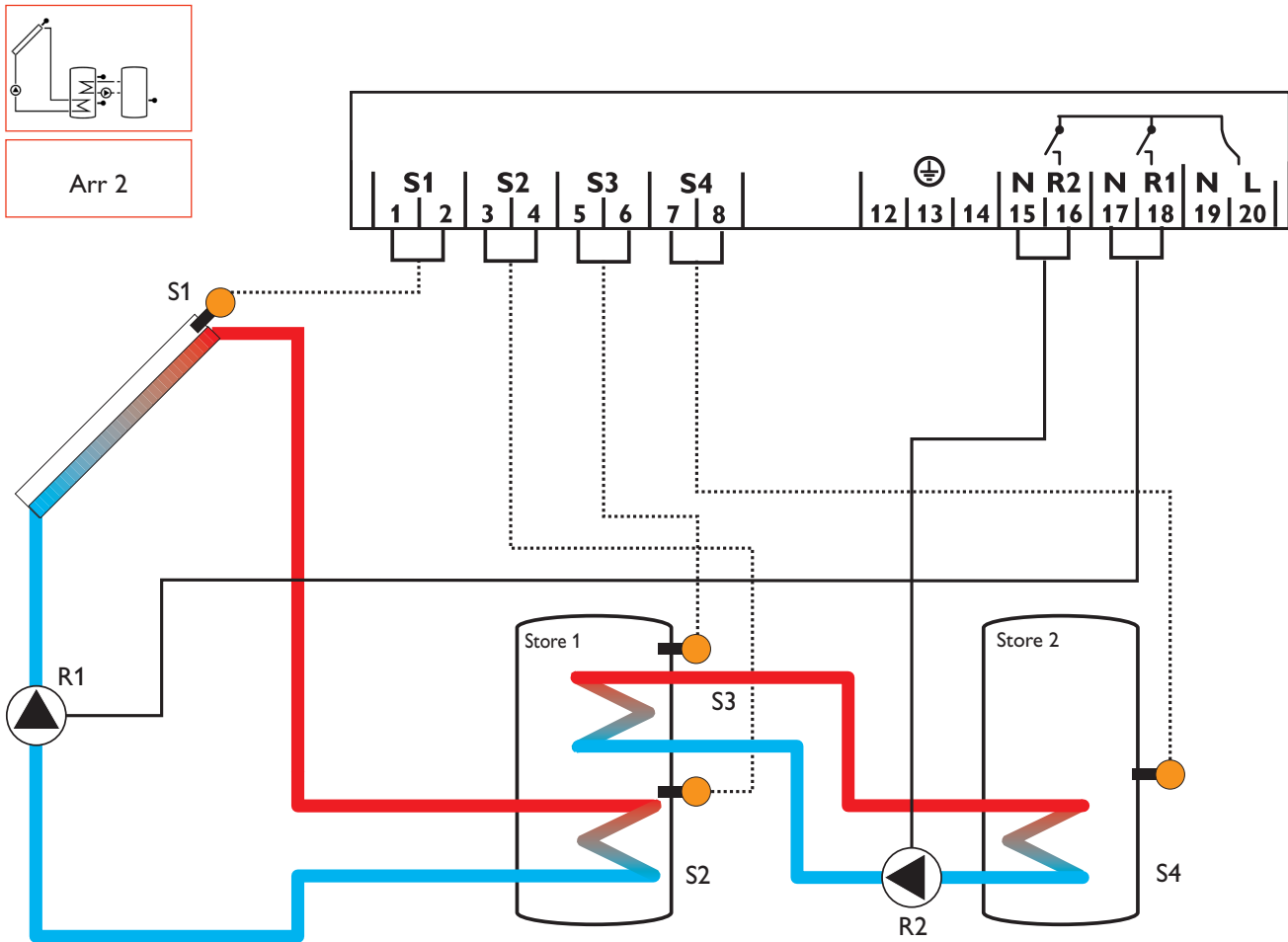

Display Channels				
Channel		Description	Terminal	Page
INIT	x*	ODB initialisation active	-	37
FLL	x*	ODB filling time active	-	37
STAB	x*	ODB stabilisation in progress	-	37
COL	x	Temperature collector	S1	37
TST1	x	Temperature store 1 base	S2	37
TSTT	x	Temperature store 1 at the top	S3	37
TST2	x	Temperature store 2 base	S4	37
n1 %	x	Pump speed R1	R1	38
n2 %	x	Pump speed R2	R2	38
h P1	x	Operating hours R1	R1	38
h P2	x	Operating hours R2	R2	38
TIME	x	Time	-	34

Adjustment Channels				
Channel		Description	Factory setting	Page
Arr	x	System	2	39
DT O	x	Switch-on temperature difference	6.0 K [12.0 °Ra]	39
DT F	x	Switch-off temperature difference	4.0 K [8.0 °Ra]	39
DT S	x	Nominal temperature difference	10.0 K [20.0 °Ra]	39
RIS	x	Rise control R1	2 K [4 °Ra]	39
n1MN	x	Minimum pump speed R1	30 %	39
S MX	x	Maximum store temperature	80 °C [176 °F]	40
OSEM	x	Option store emergency shutdown	OFF	40
n2MN	s	Minimum pump speed R2	30 %	10
EM	x	Emergency temperature collector	130 °C [270 °F]	40
		Emergency temperature collector if ODB is activated:	95 °C [200 °F]	40
OCC	x	Option collector cooling	OFF	41
CMX	x*	Maximum collector temperature	110 °C [230 °F]	41
OSYC	x	Option system cooling	OFF	41
DTCO	x*	Cooling switch-on temperature difference	20.0 K [40.0 °Ra]	41
DTCF	x*	Cooling switch-off temperature difference	15.0 K [30.0 °Ra]	41
OSTC	x	Option store cooling	OFF	42
OHOL	x*	Option holiday cooling	OFF	42
THOL	x*	Holiday cooling temperature	40 °C [110 °F]	42
OCN	x	Option minimum limitation	OFF	42
CMN	x*	Minimum collector temperature	10 °C [50 °F]	42
OCF	x	Option antifreeze	OFF	42
CFR	x*	Antifreeze temperature	4.0 °C [40.0 °F]	42
OTC	x	Option tube collector	OFF	44
TCST	x*	OTC starting time	07:00	44
TCEN	x*	OTC ending time	19:00	44
TCRU	x*	OTC runtime	30 s	44
TCIN	x*	OTC standstill interval	30 min	44
DT3O	s	Switch-on temperature difference 3	6.0 K [12.0 °Ra]	10
DT3F	s	Switch-off temperature difference 3	4.0 K [8.0 °Ra]	10
DT3S	s	Nominal temperature difference 3	10.0 K [20.0 °Ra]	10
RIS3	s	Rise control R2	2 K [4 °Ra]	10
MX3O	s	Switch-on treshold for maximum temperature	60.0 °C [140.0 °F]	11
MX3F	s	Switch-off treshold for maximum temperature	58.0 °C [136.0 °F]	11
MN3O	s	Switch-on treshold for minimum temperature	5.0 °C [40.0 °F]	11
MN3F	s	Switch-off treshold for minimum temperature	10.0 °C [50.0 °F]	11
ODB	x	Drainback option	OFF	45
tDTO	x*	ODB switch-on condition - time period	60 s	45
tFLL	x*	ODB filling time	5.0 min	45
tSTB	x*	ODB stabilisation time	2.0 min	45
MAN1	x	Manual operation R1	Auto	46
MAN2	x	Manual operation R2	Auto	46
ADA1	x	HE pump control	OFF	46
ADA2	x	HE pump control	OFF	46
LANG	x	Language	En	46
UNIT	x	Temperature unit	°C	46
RESE	x	Reset - back to factory settings		46
W005####		Version number		

Legend:

Symbol	Specification
x	Channel is available
x*	Channel is available if the corresponding option is activated.
s	Channel is specifically available in this system layout

System-specific functions

The following adjustments are used for the specific function in system layout 2.

ΔT control for the heat exchange between 2 stores

DT3O:

Switch-on temperature diff.
Adjustment range:
1.0 ... 20.0 K [2.0 ... 40.0 °Ra]
in steps of 0.5 K [1 °Ra]
Factory setting:
6.0 K [12.0 °Ra]

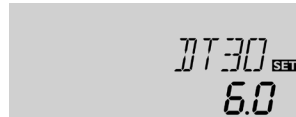

Reference sensors for this function are S3 and S4.

In system layout 2 the controller is equipped with an additional differential control for heat exchange between two stores. The basic differential function is adjusted using the switch-on (**DT3O**) and switch-off (**DT3F**) temperature differences.

When the temperature difference exceeds the switch-on temperature difference, relay 2 switches on. If the temperature difference then falls below the adjusted switch-off temperature difference, relay 2 switches off.

DT3F:

Switch-off temperature diff.
Adjustment range:
0.5 ... 19.5 K [1.0 ... 39.0 °Ra]
in steps of 0.5 K [1 °Ra]
Factory setting:
4.0 K [8.0 °Ra]

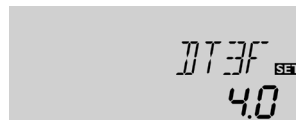

Note:

The switch-on temperature difference must be at least 0.5 K [1 °Ra] higher than the switch-off temperature difference.

Pump speed control

DT3S:

Nominal temperature difference
Adjustment range:
1.5 ... 30.0 K [3.0 ... 60.0 °Ra]
in steps of 0.5 K [1 °Ra]
Factory setting:
10.0 K [20.0 °Ra]

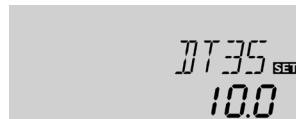

Note:

For pump speed control of the heat exchange pump, the operation mode of relay 2 (**MAN2**) must be set to Auto.

When the switch-on temperature difference is reached, the pump is activated at full speed for 10 seconds. Then, the speed is reduced to the minimum pump speed value (**n2MN**). If the temperature difference reaches the adjusted nominal temperature difference (**DT3S**), the pump speed increases by one step (10 %). If the difference increases by the adjustable rise value, the pump speed increases by 10 % respectively until the maximum pump speed of 100 % is reached. The response of the controller can be adapted via the parameter **RIS3**.

RIS3:

Rise
Adjustment range:
1 ... 20 K [2 ... 40 °Ra]
in steps of 1 K [2 °Ra]
Factory setting: 2 K [4 °Ra]



Note:

The nominal temperature difference must be at least 0.5 K [1 °Ra] higher than the switch-on temperature difference.

Minimum pump speed

n2MN:

Pump speed control
Adjustment range: 30 ... 100
in steps of 5 %
Factory setting: 30

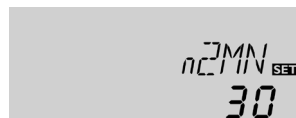

A relative minimum pump speed can be allocated to the output R2 via the adjustment channel **n2MN**.



Note:

When loads which are not speed-controlled (e.g. valves) are used, the value must be set to 100 % in order to deactivate pump speed control.

Maximum temperature limitation

MX3O / MX3F:

Maximum temperature limitation

Adjustment range:

0.0... 95.0 °C [30.0...200.0 °F]

in steps of 0.5 °C [1.0 °F]

Factory setting:

MX3O: 60.0 °C [140.0 °F]

MX3F: 58.0 °C [136.0 °F]

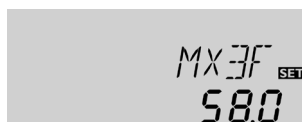

Minimum temperature limitation

MN3O / MN3F:

Minimum temperature limitation

Adjustment range:

0.0... 90.0 °C [30.0...190.0 °F]

in steps of 0.5 °C [1.0 °F]

Factory setting (Arr = 2 only):

MN3O: 5.0 °C [40.0 °F]

MN3F: 10.0 °C [50.0 °F]



Minimum and maximum temperature limits can be set for the heat exchange function.

The maximum temperature limitation uses sensor 4 as reference sensor.

The maximum temperature limitation function provides a maximum temperature setting, usually to reduce scald risk in a storage store. If **MX3O** is exceeded, relay 2 is switched off until the temperature at sensor 4 falls below **MX3F**.

The minimum temperature limitation uses sensor 3 as reference sensor.

The minimum temperature limitation function provides a minimum temperature setting for the heat source in system layout 2. If the temperature at sensor 3 falls below **MN3O**, relay 2 is switched off until the temperature at sensor 3 exceeds **MN3F**.

Both switch-on and switch-off temperature differences **DT3O** and **DT3F** are valid for the maximum and minimum temperature limitation.

System layout 3

The controller calculates the temperature difference between collector sensor S1 and store sensor S2. If the difference is larger than or identical to the adjusted switch-on temperature difference (DT O), the solar pump will be operated by relay 1, and the store will be loaded until the switch-off temperature difference (DT F) or the maximum store temperature (S MX) is reached.

Sensor S3 is used for a thermostatic function, which operates

relay 2 for afterheating or heat dump purposes, when the adjusted thermostat switch-on temperature (AH O) is reached. This function can optionally be combined with up to three adjustable time frames.

Sensor S3 can also be optionally used as a reference sensor for the thermal disinfection function OTD or the store emergency shutdown option (OSEM).

Sensor S4 can optionally be connected for measurement purposes. If heat quantity measurement (OHQM) is activated, sensor S4 has to be connected as return sensor.

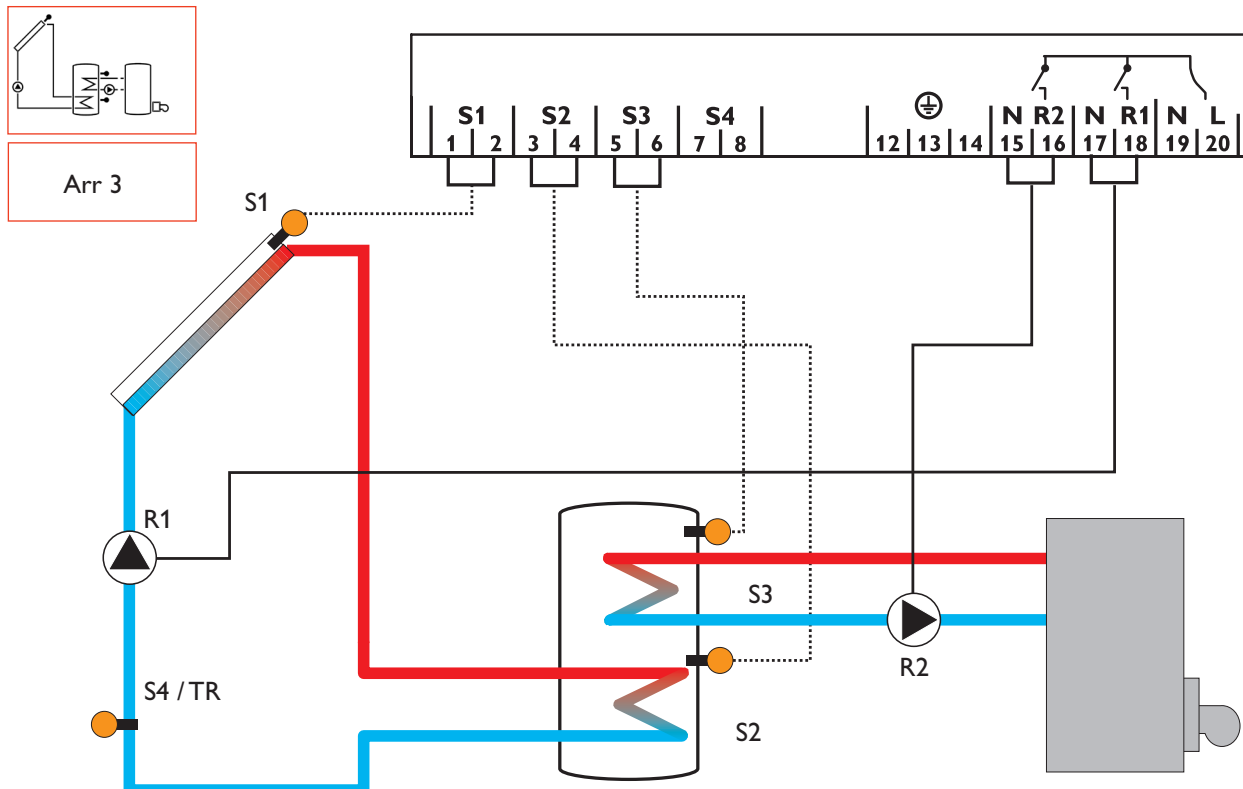

Display Channels				
Channel		Description	Terminal	Page
INIT	x*	ODB initialisation active	-	37
FLL	x*	ODB filling time active	-	37
STAB	x*	ODB stabilisation in progress	-	37
COL	x	Temperature collector	S1	37
TSTB	x	Temperature store 1 base	S2	37
TSTT	x	Temperature store 1 at the top	S3	37
TDIS	s*	Thermal disinfection temperature	S3	37
S4	x	Temperature sensor 4	S4	37
TR	x*	Temperature return sensor	S4	37
n1 %	x	Pump speed R1	R1	38
h P1	x	Operating hours R1	R1	38
h P2	x	Operating hours R2	R2	38
kWh	x*	Heat quantity kWh	-	38
MWh	x*	Heat quantity MWh	-	38
CDIS	s*	Countdown of monitoring period	-	38
SDIS	s*	Starting time display	-	38
DDIS	s*	Heating period display	-	38
TIME	x	Time	-	34

Adjustment Channels				
Channel		Description	Factory setting	Page
Arr	x	System	3	39
DT O	x	Switch-on temperature difference	6.0 K [12.0 °Ra]	39
DT F	x	Switch-off temperature difference	4.0 K [8.0 °Ra]	39
DT S	x	Nominal temperature difference	10.0 K [20.0 °Ra]	39
RIS	x	Rise control R1	2 K [4 °Ra]	39
n1MN	x	Minimum pump speed R1	30 %	39
S MX	x	Maximum store temperature	80 °C [176 °F]	40
OSEM	x	Option store emergency shutdown	OFF	40
EM	x	Emergency temperature collector	130 °C [270 °F]	40
		Emergency temperature collector if ODB is activated:	95 °C [200 °F]	40
OCC	x	Option collector cooling	OFF	41
CMX	x*	Maximum collector temperature	110 °C [230 °F]	41
OSYC	x	Option system cooling	OFF	41
DTCO	x*	Cooling switch-on temperature difference	20.0 K [40.0 °Ra]	41
DTCF	x*	Cooling switch-off temperature difference	15.0 K [30.0 °Ra]	41
OSTC	x	Option store cooling	OFF	42
OHOL	x*	Option holiday cooling	OFF	42
THOL	x*	Holiday cooling temperature	40 °C [110 °F]	42
OCN	x	Option minimum limitation	OFF	42
CMN	x*	Minimum collector temperature	10 °C [50 °F]	42
OCF	x	Option antifreeze	OFF	42
CFR	x*	Antifreeze temperature	4.0 °C [40.0 °F]	42
OTC	x	Option tube collector	OFF	44
TCST	x*	OTC starting time	07:00	44
TCEN	x*	OTC ending time	19:00	44
TCRU	x*	OTC runtime	30 s	44
TCIN	x*	OTC standstill interval	30 min	44
OHQM	x	Option heat quantity measurement	OFF	44
FMAX	x*	Maximum flow	2.0 l	44
MEDT	x*	Antifreeze type	1	44
MED%	x*	Antifreeze concentration	45 %	44
AH O	s	Switch-on temp. for thermostat 1	40 °C [110 °F]	14
AH F	s	Switch-off temp. for thermostat 1	45 °C [120 °F]	14
t1 O	s	Switch-on time 1 thermostat	00:00	14
t1 F	s	Switch-off time 1 thermostat	00:00	14
t2 O	s	Switch-on time 2 thermostat	00:00	14
t2 F	s	Switch-off time 2 thermostat	00:00	14
t3 O	s	Switch-on time 3 thermostat	00:00	14
t3 F	s	Switch-off time 3 thermostat	00:00	14
ODB	x	Drainback option	OFF	45
tDTO	x*	ODB switch-on condition - time period	60 s	45
tFLL	x*	ODB filling time	5.0 min	45
tSTB	x*	ODB stabilisation time	2.0 min	45
OTD	s	Option thermal disinfection	OFF	15
PDIS	s*	Monitoring period	01:00	15
DDIS	s*	Heating period	01:00	15
TDIS	s*	Disinfection temperature	80 °C [176 °F]	15
SDIS	s*	Starting time	00:00	15
MAN1	x	Manual operation R1	Auto	46
MAN2	x	Manual operation R2	Auto	46
ADA1	x	HE pump control	OFF	46
LANG	x	Language	En	46
UNIT	x	Temperature unit	°C	46
RESE	x	Reset - back to factory settings		46
VW005####		Version number		

Legend:

Symbol	Specification
x	Channel is available
x*	Channel is available if the corresponding option is activated.
s	Channel is specifically available in this system layout
s*	System-specific channel, only available if the corresponding option is activated

System-specific functions

The following functions are exclusively available in system layout 3. The corresponding channels will not be available in any other system layout.

Thermostat function

Afterheating

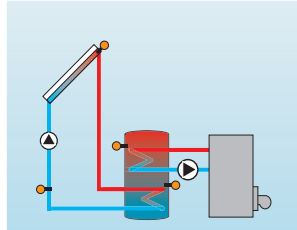

The thermostat function works independently from the solar operation and can be used for using surplus energy or for afterheating.

- **AH O < AH F**
thermostat function for afterheating
- **AH O > AH F**
thermostat function for using surplus energy

Use of surplus energy

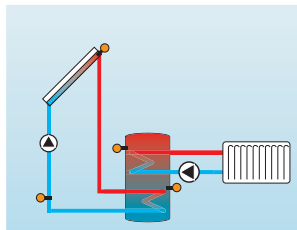

The symbol will be shown on the display if the second relay output is activated.

Reference sensor for the thermostat function is S3!

AH O:

Thermostat switch-on temp.

Adjustment range:

0.0 ... 95.0 °C

[30.0 ... 200.0 °F]

in steps of 0.5 °C [1.0 °F]

Factory setting:

40.0 °C [110.0 °F]



AH F:

Thermostat switch-off temp.

Adjustment range:

0.0 ... 95.0 °C

[30.0 ... 200.0 °F]

in steps of 0.5 °C [1.0 °F]

Factory setting:

45.0 °C [120.0 °F]



t1 O, t2 O, t3 O:

Thermostat switch-on time

Adjustment range:

00:00 ... 23:45

Factory setting: 00:00

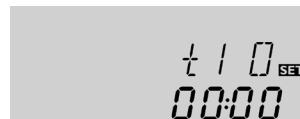

In order to block the thermostat function for a certain period, there are three time frames t1 ... t3. If the function should be active between 6:00 and 9:00, set t1 O to 6:00 and t1 F to 9:00.

If all time frames are set to 00:00 o'clock, the thermostat function is continuously activated (factory setting).

t1 F, t2 F, t3 F:

Thermostat switch-off time

Adjustment range:

00:00 ... 23:45

Factory setting: 00:00



Option: Thermal disinfection of the upper DHW zone (OTD)

OTD

Thermal disinfection function
Adjustment range: ON/OFF
Factory setting: OFF



PDIS

Monitoring period
Adjustment range:
0 ... 30:0 ... 24 h (dd:hh)
Factory setting: 01:00



DDIS

Heating period
Adjustment range:
00:00 ... 23:59 (hh:mm)
Factory setting: 01:00

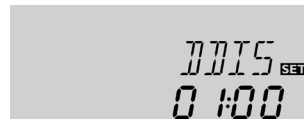

TDIS

Disinfection temperature
Adjustment range:
0 ... 95 °C [30 ... 200 °F]
in steps of 2 °C [2 °F]
Factory setting:
60 °C [140 °F]

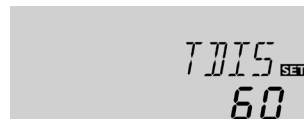

This function is used for protecting the upper store zone against Legionella by activating the afterheating.

Reference sensor for the thermal disinfection is S3!

➔ To activate the function, select “On” in the **OTD** channel.

For thermal disinfection, the temperature in the upper DHW store zone has to be monitored. This protection is ensured when, during the monitoring period (**PDIS**), the disinfection temperature (**TDIS**) is continuously exceeded for the entire heating period (**DDIS**). S3 is used as the reference sensor and displayed as **TSTT**.

If **OTD** is activated, **PDIS** will start as soon as the temperature at S3 falls below **TDIS**. The display channel **CDIS** appears, counting backwards the remaining time of **PDIS**. If, during the monitoring period, the temperature at S3 exceeds **TDIS** continuously for the duration of **DDIS**, thermal disinfection is considered complete and a new monitoring period begins.

If **CDIS** counts down to 00:00, relay 2 will be operated in order to use the afterheating for thermal disinfection. **CDIS** will then be replaced with a display channel **DDIS** showing the adjusted heating period. **DDIS** will start counting down the heating period as soon as **TDIS** is exceeded at S3. As long as **DDIS** is active, the temperature at S3 will be displayed as **TDIS** instead of **TSTT**.

If, during **DDIS**, the temperature at S3 exceeds **TDIS** by more than 5 K [10 °Ra], relay 2 is switched off until the temperature falls below **TDIS** + 2 K [4 °Ra].

If, during **DDIS**, the temperature at S3 falls below **TDIS**, the heating period will restart. **DDIS** can only be completed when **TDIS** is exceeded without interruption.

Due to the flexible control logic, the exact time of thermal disinfection is not predictable. In order to set a fixed time for the disinfection to be run, the starting delay **SDIS** must be employed:

Thermal disinfection with starting delay

SDIS

Starting time
Adjustment range:
00:00 ... 24:00 (o'clock)
in steps of: 00:01
Factory setting: 00:00

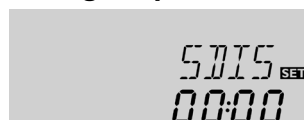

When a starting time for thermal disinfection with starting delay is adjusted in **SDIS**, the thermal disinfection will be delayed until that time, even after the **CDIS** has counted down to 00:00. If **CDIS** ends, for example, at 12:00 o'clock, and **SDIS** has been set to 18:30, relay 2 will be operated with a delay of 6.5 hours at 18:30 instead of 12:00.

During the waiting time, **SDIS** is displayed with the adjusted starting time (flashing).

If, during the waiting time, the temperature at S3 exceeds **TDIS** for the adjusted heating period **DDIS**, thermal disinfection is considered complete and a new monitoring period begins.

If the starting time is adjusted to 00:00 (factory setting), the delay function is inactive.

Upon delivery, **OTD** is deactivated. The adjustment values **PDIS**, **TDIS**, **DDIS** and **SDIS** are displayed after the option has been activated. After the thermal disinfection function has been completed, the values will be “hidden” and the monitoring period will be displayed.

System layout 4

The controller calculates the temperature differences between collector sensor S1 and store sensors S2 and S3. If the differences are larger than or identical to the adjusted switch-on temperature differences (DT1O / DT2O), the solar pump will be operated by relay 1, and the respective store zone will be loaded until the switch-off temperature differences (DT1F / DT2F) or the maximum store tempera-

tures (S1MX / S2MX) are reached. The priority logic causes priority loading of the upper zone of the store, if possible. The 3-way-valve will be operated by relay 2 then.

Sensor S4 can optionally be connected for measurement purposes.

If heat quantity measurement (OHQM) is activated, sensor S4 has to be connected as return sensor.

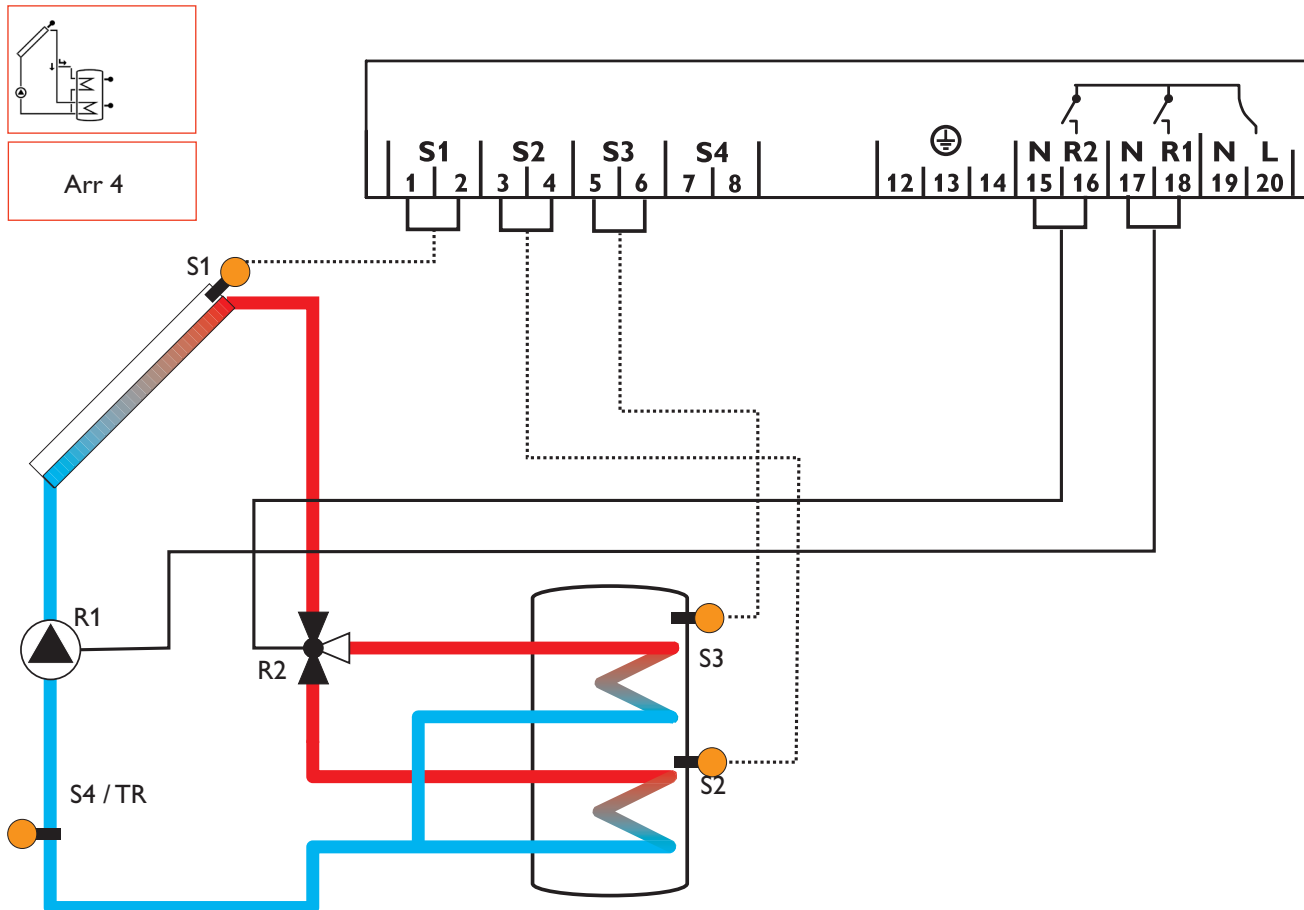

Display Channels				
Channel		Description	Terminal	Page
COL	x	Temperature collector	S1	37
TSTB	x	Temperature store 1 base	S2	37
TSTT	x	Temperature store 1 at the top	S3	37
S4	x	Temperature sensor 4	S4	37
TR	x*	Temperature return sensor	S4	37
n %	x	Pump speed relay	R1	38
hP1	x	Operating hours R1	R1	38
hP2	x	Operating hours R2	R2	38
kWh	x*	Heat quantity kWh	-	38
MWh	x*	Heat quantity MWh	-	38
TIME	x	Time	-	34

Adjustment Channels				
Channel		Description	Factory setting	Page
Arr	x	System	4	39
nMN	x	Minimum pump speed	30 %	39
DT1O	x	Switch-on temperature difference 1	6.0 K [12.0 °Ra]	39
DT1F	x	Switch-off temperature difference 1	4.0 K [8.0 °Ra]	39
DT1S	x	Nominal temperature difference 1	10.0 K [20.0 °Ra]	39
RIS1	x	Rise control R1	2 K [4 °Ra]	39
S1 MX	x	Maximum temperature store 1	80 °C [176 °F]	40
DT2O	x	Switch-on temperature difference 2	6.0 K [12.0 °Ra]	39
DT2F	x	Switch-off temperature difference 2	4.0 K [8.0 °Ra]	39
DT2S	x	Nominal temperature difference 2	10.0 K [20.0 °Ra]	39
RIS2	x	Rise control R2	2 K [4 °Ra]	39
S2MX	x	Maximum temperature store 2	80 °C [176 °F]	40
EM	x	Emergency temperature collector	130 °C [270 °F]	40
OCC	x	Option collector cooling	OFF	41
CMX	x*	Maximum collector temperature	110 °C [230 °F]	41
OSYC	x	Option system cooling	OFF	41
DTCO	x*	Cooling switch-on temperature difference	20.0 K [40.0 °Ra]	41
DTCF	x*	Cooling switch-off temperature difference	15.0 K [30.0 °Ra]	41
OSTC	x	Option store cooling	OFF	42
OHOL	x*	Option holiday cooling	OFF	42
THOL	x*	Holiday cooling temperature	40 °C [110 °F]	42
OCN	x	Option minimum limitation	OFF	42
CMN	x*	Minimum collector temperature	10 °C [50 °F]	42
OCF	x	Option antifreeze	OFF	42
CFR	x*	Antifreeze temperature	4.0 °C [40.0 °F]	42
PRIO	x	Priority	2	43
tLB	x	Break time	2 min	43
tRUN	x	Circulation runtime	15 min	43
OTC	x	Option tube collector	OFF	44
TCST	x*	OTC starting time	07:00	44
TCEN	x*	OTC ending time	19:00	44
TCRU	x*	OTC runtime	30 s	44
TCIN	x*	OTC standstill interval	30 min	44
OHQM	x	Option heat quantity measurement	OFF	44
FMAX	x*	Maximum flow	2.0 l	44
MEDT	x*	Antifreeze type	1	44
MED%	x*	Antifreeze concentration (only if MEDT = propylene or ethylene)	45 %	44
MAN1	x	Manual operation R1	Auto	46
MAN2	x	Manual operation R2	Auto	46
ADA1	x	HE pump control	OFF	46
LANG	x	Language	En	46
UNIT	x	Temperature unit	°C	46
RESE	x	Reset - back to factory settings		46
W005####		Version number		

Legend:

Symbol	Specification
x	Channel is available
x*	Channel is available if the corresponding option is activated.

System layout 5

The controller calculates the temperature differences between collector sensor S1 and store sensors S2 and S3. If the differences are larger than or identical to the adjusted switch-on temperature differences (DT1O / DT2O), the solar pump will be operated by relay 1, and the respective store will be loaded until the switch-off temperature differences (DT1F / DT2F) or the maximum store temperatures

(S1MX / S2MX) are reached. The priority logic causes priority loading of store 1, if possible. For loading store 2 the 3-way-valve will be operated by relay 2.

Sensor S4 can optionally be connected for measurement purposes.

If heat quantity measurement (OHQM) is activated, sensor S4 has to be connected as return sensor.

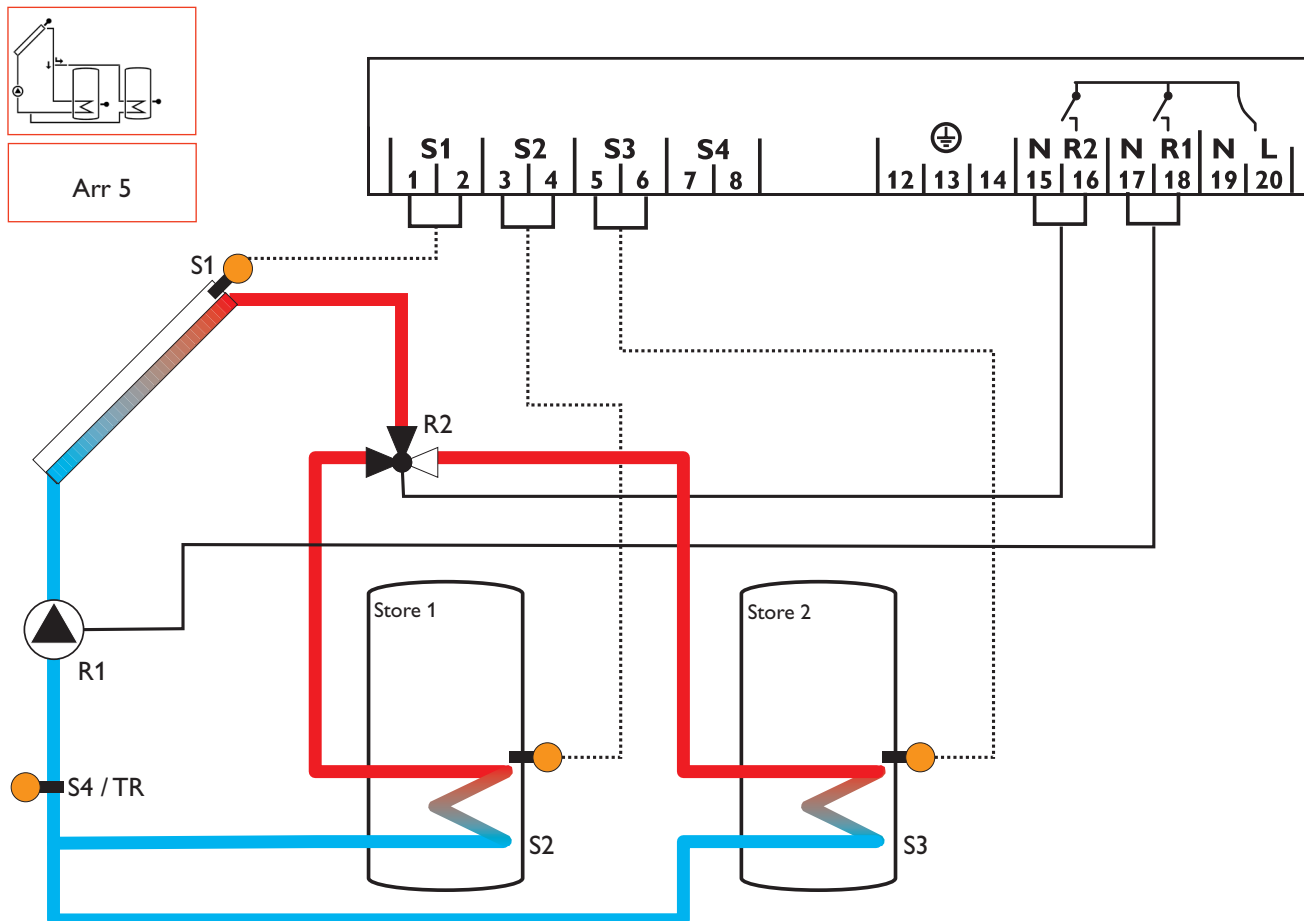

Display Channels				
Channel		Description	Terminal	Page
COL	x	Temperature collector	S1	37
TST1	x	Temperature store 1 base	S2	37
TST2	x	Temperature store 2 base	S3	37
S4	x	Temperature sensor 4	S4	37
TR	x*	Temperature return sensor	S4	37
n %	x	Pump speed relay	R1	38
hP1	x	Operating hours R1	R1	38
hP2	x	Operating hours R2	R2	38
kWh	x*	Heat quantity kWh	-	38
MWh	x*	Heat quantity MWh	-	38
TIME	x	Time	-	34

Adjustment Channels				
Channel		Description	Factory setting	Page
Arr	x	System	5	39
nMN	x	Minimum pump speed	30 %	39
DT1O	x	Switch-on temperature difference 1	6.0 K [12.0 °Ra]	39
DT1F	x	Switch-off temperature difference 1	4.0 K [8.0 °Ra]	39
DT1S	x	Nominal temperature difference 1	10.0 K [20.0 °Ra]	39
RIS1	x	Rise control R1	2 K [4 °Ra]	39
S1 MX	x	Maximum temperature store 1	80 °C [176 °F]	40
DT2O	x	Switch-on temperature difference 2	6.0 K [12.0 °Ra]	39
DT2F	x	Switch-off temperature difference 2	4.0 K [8.0 °Ra]	39
DT2S	x	Nominal temperature difference 2	10.0 K [20.0 °Ra]	39
RIS2	x	Rise control R2	2 K [4 °Ra]	39
S2MX	x	Maximum temperature store 2	80 °C [176 °F]	40
EM	x	Emergency temperature collector	130 °C [270 °F]	40
OCC	x	Option collector cooling	OFF	41
CMX	x*	Maximum collector temperature	110 °C [230 °F]	41
OSYC	x	Option system cooling	OFF	41
DTCO	x*	Cooling switch-on temperature difference	20.0 K [40.0 °Ra]	41
DTCF	x*	Cooling switch-off temperature difference	15.0 K [30.0 °Ra]	41
OSTC	x	Option store cooling	OFF	42
OHOL	x*	Option holiday cooling	OFF	42
THOL	x*	Holiday cooling temperature	40 °C [110 °F]	42
OCN	x	Option minimum limitation	OFF	42
CMN	x*	Minimum collector temperature	10 °C [50 °F]	42
OCF	x	Option antifreeze	OFF	42
CFR	x*	Antifreeze temperature	4.0 °C [40.0 °F]	42
PRIO	x	Priority	1	43
tLB	x	Break time	2 min	43
tRUN	x	Circulation runtime	15 min	43
OTC	x	Option tube collector	OFF	44
TCST	x*	OTC starting time	07:00	44
TCEN	x*	OTC ending time	19:00	44
TCRU	x*	OTC runtime	30 s	44
TCIN	x*	OTC standstill interval	30 min	44
OHQM	x	Option heat quantity measurement	OFF	44
FMAX	x*	Maximum flow	2.0 l	44
MEDT	x*	Antifreeze type	1	44
MED%	x*	Antifreeze concentration (only if MEDT = propylene or ethylene)	45 %	44
MAN1	x	Manual operation R1	Auto	46
MAN2	x	Manual operation R2	Auto	46
ADA1	x	HE pump control	OFF	46
LANG	x	Language	En	46
UNIT	x	Temperature unit	°C	46
RESE	x	Reset - back to factory settings		46
W005####		Version number		

Legend:

Symbol	Specification
x	Channel is available
x*	Channel is available if the corresponding option is activated.

System layout 6

The controller calculates the temperature differences between collector sensor S1 and store sensors S2 and S3. If the differences are larger than or identical to the adjusted switch-on temperature differences (DT1O / DT2O), the solar pumps will be operated by relay 1 and / or relay 2, and the respective store will be loaded until the switch-off temperature differences (DT1F / DT2F) or the maximum

store temperatures (S1MX / S2MX) are reached. The priority logic causes priority loading of the selected store (PRIO), if possible. Loading both stores simultaneously is possible as well (PRIO = 0).

Sensor S4 can optionally be connected for measurement purposes or used as reference sensor for the store emergency shutdown option (OSEM).

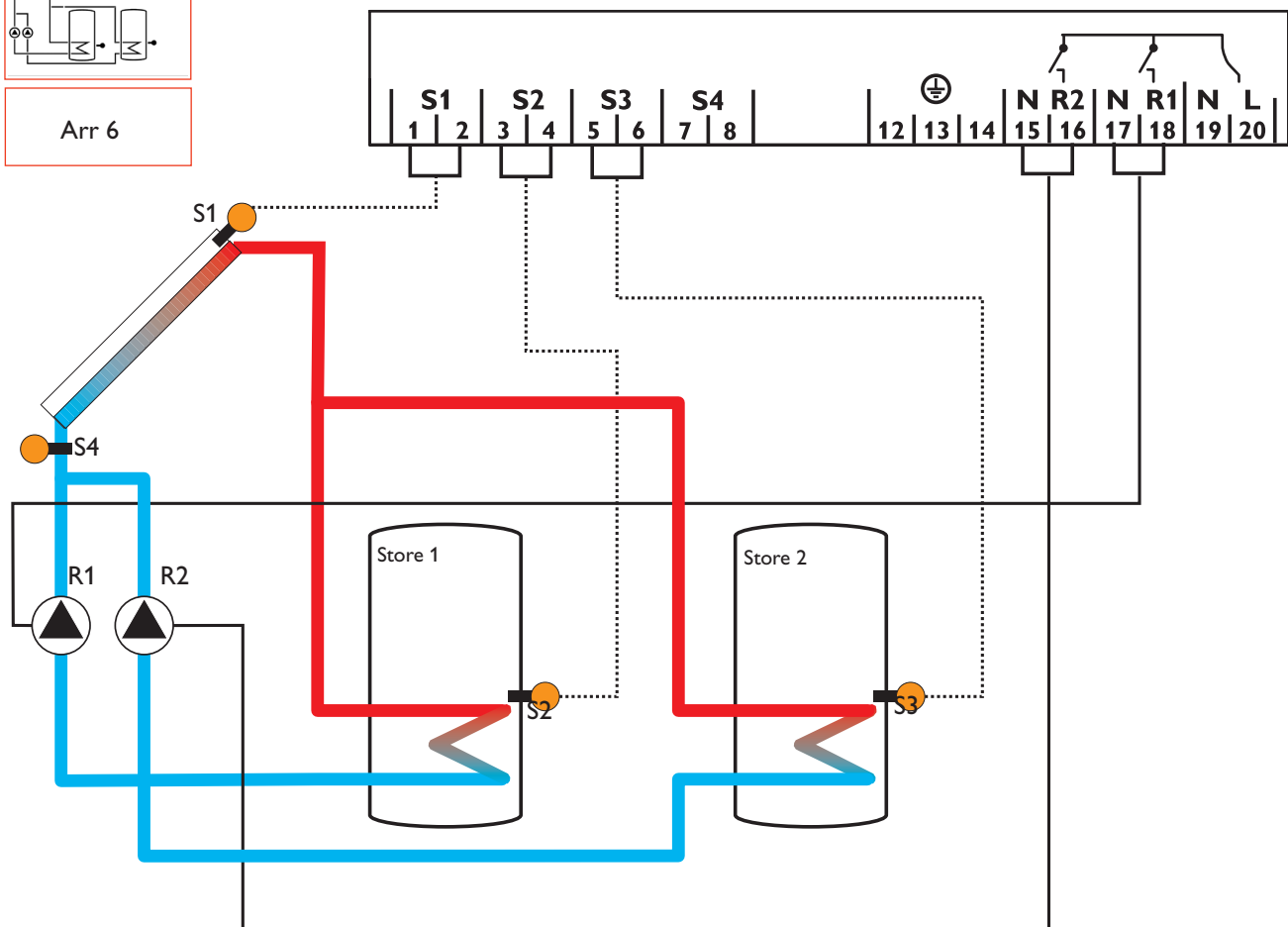
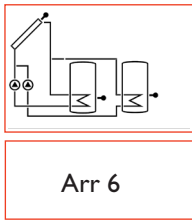

Display Channels				
Channel		Description	Terminal	Page
COL	x	Temperature collector	S1	37
TST1	x	Temperature store 1 base	S2	37
TST2	x	Temperature store 2 base	S3	37
S4	x	Temperature sensor 4	S4	37
TSTT	x*	Temperature store at the top	S4	37
n1 %	x	Pump speed R1	R1	38
n2 %	x	Pump speed R2	R2	38
h P1	x	Operating hours R1	R1	38
h P2	x	Operating hours R2	R2	38
TIME	x	Time	-	34

Adjustment Channels				
Channel		Description	Factory setting	Page
Arr	x	System	6	39
DT1O	x	Switch-on temperature difference 1	6.0 K [12.0 °Ra]	39
DT1F	x	Switch-off temperature difference 1	4.0 K [8.0 °Ra]	39
DT1S	x	Nominal temperature difference 1	10.0 K [20.0 °Ra]	39
RIS1	x	Rise control R1	2 K [4 °Ra]	39
n1MN	x	Minimum pump speed R1	30 %	39
S1 MX	x	Maximum temperature store 1	80 °C [176 °F]	40
OSEM	x	Option store emergency shutdown	OFF	40
DT2O	x	Switch-on temperature difference 2	6.0 K [12.0 °Ra]	39
DT2F	x	Switch-off temperature difference 2	4.0 K [8.0 °Ra]	39
DT2S	x	Nominal temperature difference 2	10.0 K [20.0 °Ra]	39
RIS2	x	Rise control R2	2 K [4 °Ra]	39
n2MN	x	Minimum pump speed R2	30 %	39
S2MX	x	Maximum temperature store 2	80 °C [176 °F]	40
EM	x	Emergency temperature collector	130 °C [270 °F]	40
OCC	x	Option collector cooling	OFF	41
CMX	x*	Maximum collector temperature	110 °C [230 °F]	41
OSYC	x	Option system cooling	OFF	41
DTCO	x*	Cooling switch-on temperature difference	20.0 K [40.0 °Ra]	41
DTCF	x*	Cooling switch-off temperature difference	15.0 K [30.0 °Ra]	41
OSTC	x	Option store cooling	OFF	42
OHOL	x*	Option holiday cooling	OFF	42
THOL	x*	Holiday cooling temperature	40 °C [110 °F]	42
OCN	x	Option minimum limitation	OFF	42
CMN	x*	Minimum collector temperature	10 °C [50 °F]	42
OCF	x	Option antifreeze	OFF	42
CFR	x*	Antifreeze temperature	4.0 °C [40.0 °F]	42
PRIO	x	Priority	1	43
tLB	x	Break time	2 min	43
tRUN	x	Circulation runtime	15 min	43
DTSE	x*	Spread temperature difference	40 K [70 °Ra]	43
OTC	x	Option tube collector	OFF	44
TCST	x*	OTC starting time	07:00	44
TCEN	x*	OTC ending time	19:00	44
TCRU	x*	OTC runtime	30 s	44
TCIN	x*	OTC standstill interval	30 min	44
MAN1	x	Manual operation R1	Auto	46
MAN2	x	Manual operation R2	Auto	46
ADA1	x	HE pump control	OFF	46
ADA2	x	HE pump control	OFF	46
LANG	x	Language	En	46
UNIT	x	Temperature unit	°C	46
RESE	x	Reset - back to factory settings		46
W005####		Version number		

Legend:

Symbol	Specification
x	Channel is available
x*	Channel is available if the corresponding option is activated.

System layout 7

The controller calculates the temperature differences between the collector sensors S1 and S3 and the store sensor S2. If the differences are larger than or identical to the adjusted switch-on temperature difference (DT O), the respective solar pump will be operated by relay 1 and / or relay 2, and the store will be loaded until the switch-off

temperature difference (DT F) or the maximum store temperature (S MX) is reached.

Sensor S4 can optionally be connected for measurement purposes or used as reference sensor for the store emergency shutdown option (OSEM).

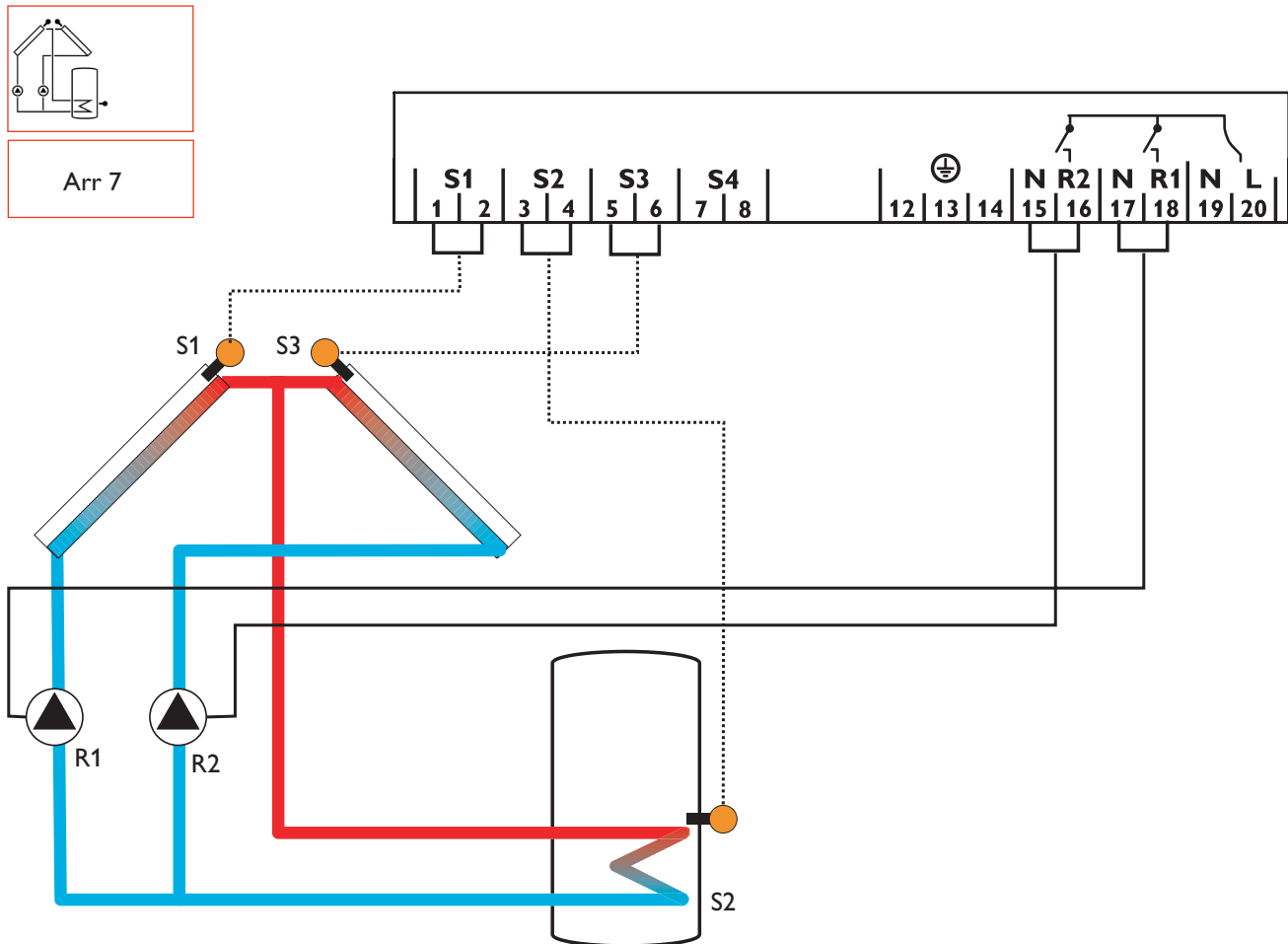

Display Channels				
Channel		Description	Terminal	Page
COL1	x	Temperature collector 1	S1	37
TST	x	Temperature store	S2	37
COL2	x	Temperature collector 2	S3	37
S4	x	Temperature sensor 4	S4	37
TSTT	x*	Temperature store at the top	S4	37
n1 %	x	Pump speed R1	R1	38
n2 %	x	Pump speed R2	R2	38
h P1	x	Operating hours R1	R1	38
h P2	x	Operating hours R2	R2	38
TIME	x	Time	-	34

Adjustment Channels				
Channel		Description	Factory setting	Page
Arr	x	System	7	39
DT O	x	Switch-on temperature difference	6.0 K [12.0 °Ra]	39
DT F	x	Switch-off temperature difference	4.0 K [8.0 °Ra]	39
DT S	x	Nominal temperature difference	10.0 K [20.0 °Ra]	39
RIS	x	Rise control R1 / R2	2 K [4 °Ra]	39
n1MN	x	Minimum pump speed R1	30 %	39
S MX	x	Maximum store temperature	80 °C [176 °F]	40
OSEM	x	Option store emergency shutdown	OFF	40
n2MN	x	Minimum pump speed R2	30 %	39
EM1	x	Emergency temperature collector	130 °C [270 °F]	40
EM2	x	Emergency temperature collector	130 °C [270 °F]	40
OCC1	x	Option collector cooling collector 1	OFF	41
CMX1	x*	Maximum temperature collector 1	110 °C [230 °F]	41
OCC2	x	Option collector cooling collector 2	OFF	41
CMX2	x*	Maximum temperature collector 2	110 °C [230 °F]	41
OSYC	x	Option system cooling	OFF	41
DTCO	x*	Cooling switch-on temperature difference	20.0 K [40.0 °Ra]	41
DTCF	x*	Cooling switch-off temperature difference	15.0 K [30.0 °Ra]	41
OSTC	x	Option store cooling	OFF	42
OHOL	x*	Option holiday cooling	OFF	42
THOL	x*	Holiday cooling temperature	40 °C [110 °F]	42
OCN1	x	Option minimum limitation collector 1	OFF	42
CMN1	x*	Minimum temperature collector 1	10 °C [50 °F]	42
OCN2	x	Option minimum limitation collector 2	OFF	42
CMN2	x*	Minimum temperature collector 2	10 °C [50 °F]	42
OCF1	x	Option antifreeze collector 1	OFF	42
CFR1	x*	Antifreeze temperature collector 1	4.0 °C [40.0 °F]	42
OCF2	x	Option antifreeze collector 2	OFF	42
CFR2	x*	Antifreeze temperature collector 2	4.0 °C [40.0 °F]	42
OTC	x	Option tube collector	OFF	44
TCST	x*	OTC starting time	07:00	44
TCEN	x*	OTC ending time	19:00	44
TCRU	x*	OTC runtime	30 s	44
TCIN	x*	OTC standstill interval	30 min	44
MAN1	x	Manual operation R1	Auto	46
MAN2	x	Manual operation R2	Auto	46
ADA1	x	HE pump control	OFF	46
ADA2	x	HE pump control	OFF	46
LANG	x	Language	En	46
UNIT	x	Temperature unit	°C	46
RESE	x	Reset - back to factory settings		46
W005####		Version number		

Legend:

Symbol	Specification
x	Channel is available
x*	Channel is available if the corresponding option is activated.

System layout 8

The controller calculates the temperature difference between collector sensor S1 and store sensor S2. If the difference is larger than or identical to the adjusted switch-on temperature difference (DT O), the solar pump will be operated by relay 1, and the store will be loaded until the switch-off temperature difference (DT F) or the maximum store temperature (S MX) is reached.

A solid fuel boiler will be operated by relay 2, if the temperature difference between sensors S4 and S3 is larger than or identical to the adjusted switch-on temperature difference (DT3O), until the adjusted minimum (MN3O) and maximum (MX3O) temperature thresholds of the fuel boiler and the store are reached. S3 can optionally be used as reference sensor for the store emergency shutdown option (OSEM).

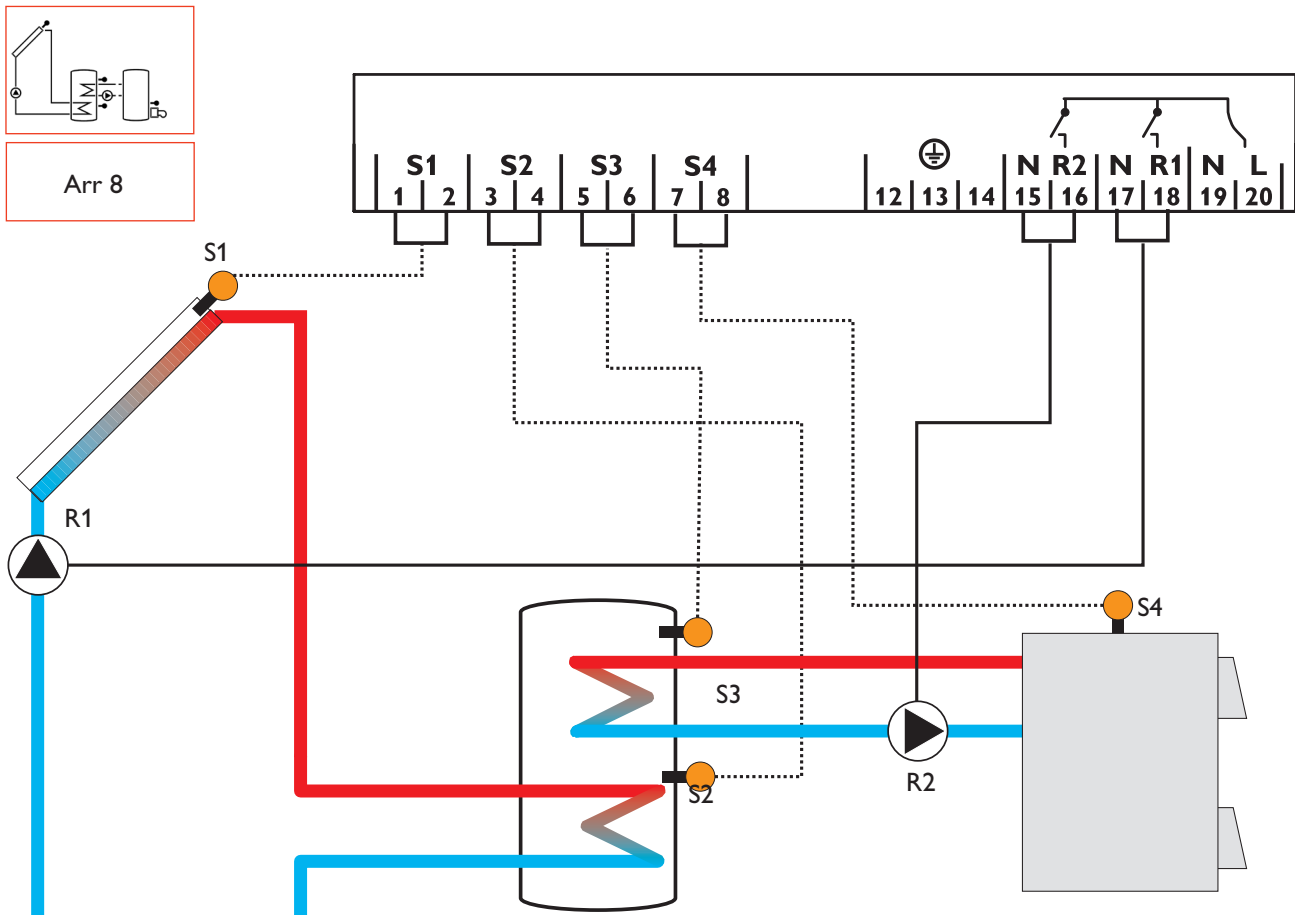

Display Channels				
Channel		Description	Terminal	Page
INIT	x*	ODB initialisation active	-	37
FLL	x*	ODB filling time active	-	37
STAB	x*	ODB stabilisation in progress	-	37
COL	x	Temperature collector	S1	37
TSTB	x	Temperature store 1 base	S2	37
TSTT	x	Temperature store 1 at the top	S3	37
TSFB	x	Temperature solid fuel boiler	S4	37
n1 %	x	Pump speed R1	R1	38
n2 %	x	Pump speed R2	R2	38
h P1	x	Operating hours R1	R1	38
h P2	x	Operating hours R2	R2	38
TIME	x	Time	-	34

Adjustment Channels				
Channel		Description	Factory setting	Page
Arr	x	System	8	39
DT O	x	Switch-on temperature difference	6.0 K [12.0 °Ra]	39
DT F	x	Switch-off temperature difference	4.0 K [8.0 °Ra]	39
DT S	x	Nominal temperature difference	10.0 K [20.0 °Ra]	39
RIS	x	Rise control R1	2 K [4 °Ra]	39
n1MN	x	Minimum pump speed R1	30 %	39
S MX	x	Maximum store temperature	80 °C [176 °F]	40
OSEM	x	Option store emergency shutdown	OFF	40
n2MN	s	Minimum pump speed R2	30 %	26
EM	x	Emergency temperature collector	130 °C [270 °F]	40
		Emergency temperature collector if ODB is activated:	95 °C [200 °F]	40
OCC	x	Option collector cooling	OFF	41
CMX	x*	Maximum collector temperature	110 °C [230 °F]	41
OSYC	x	Option system cooling	OFF	41
DTCO	x*	Cooling switch-on temperature difference	20.0 K [40.0 °Ra]	41
DTCF	x*	Cooling switch-off temperature difference	15.0 K [30.0 °Ra]	41
OSTC	x	Option store cooling	OFF	42
OHOL	x*	Option holiday cooling	OFF	42
THOL	x*	Holiday cooling temperature	40 °C [110 °F]	42
OCN	x	Option minimum limitation	OFF	42
CMN	x*	Minimum collector temperature	10 °C [50 °F]	42
OCF	x	Option antifreeze	OFF	42
CFR	x*	Antifreeze temperature	4.0 °C [40.0 °F]	42
O TC	x	Option tube collector	OFF	44
TCST	x*	OTC starting time	07:00	44
TCEN	x*	OTC ending time	19:00	44
TCRU	x*	OTC runtime	30 s	44
TCIN	x*	OTC standstill interval	30 min	44
DT3O	s	Switch-on temperature difference 3	6.0 K [12.0 °Ra]	26
DT3F	s	Switch-off temperature difference 3	4.0 K [8.0 °Ra]	26
DT3S	s	Nominal temperature difference 3	10.0 K [20.0 °Ra]	26
RIS3	s	Rise control R2	2 K [4 °Ra]	26
MX3O	s	Switch-on treshold for maximum temperature	60.0 °C [140.0 °F]	27
MX3F	s	Switch-off treshold for maximum temperature	58.0 °C [136.0 °F]	27
MN3O	s	Switch-on treshold for minimum temperature	60.0 °C [140.0 °F]	27
MN3F	s	Switch-off treshold for minimum temperature	65.0 °C [150.0 °F]	27
ODB	x	Drainback option	OFF	45
tDTO	x*	ODB switch-on condition - time period	60 s	45
tFLL	x*	ODB filling time	5.0 min	45
tSTB	x*	ODB stabilisation time	2.0 min	45
MAN1	x	Manual operation R1	Auto	46
MAN2	x	Manual operation R2	Auto	46
ADA1	x	HE pump control	OFF	46
ADA2	x	HE pump control	OFF	46
LANG	x	Language	En	46
UNIT	x	Temperature unit	°C	46
RESE	x	Reset - back to factory settings		46
VW005####		Version number		

Legend:

Symbol	Specification
x	Channel is available
x*	Channel is available if the corresponding option is activated.
s	Channel is specifically available in this system layout

System-specific functions

ΔT control for afterheating by solid fuel boiler

DT3O:

Switch-on temperature diff.
Adjustment range:
1.0 ... 20.0 K [2.0 ... 40.0 °Ra]
in steps of 0.5 K [1 °Ra]
Factory setting:
6.0 K [12.0 °Ra]

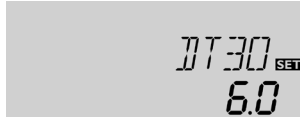

DT3F:

Switch-off temperature diff.
Adjustment range:
0.5 ... 19.5 K [1.0 ... 39.0 °Ra]
in steps of 0.5 K [1 °Ra]
Factory setting:
4.0 K [8.0 °Ra]

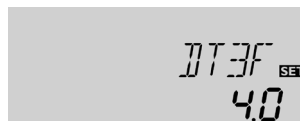

Pump speed control

DT3S:

Nominal temperature difference
Adjustment range:
1.5 ... 30.0 K [3.0 ... 60.0 °Ra]
in steps of 0.5 K [1 °Ra]
Factory setting:
10.0 K [20.0 °Ra]



RIS3:

Rise
Adjustment range:
1 ... 20 K [2 ... 40 °Ra]
in steps of 1 K [2 °Ra]
Factory setting: 2 K [4 °Ra]



Minimum pump speed

n2MN:

Pump speed control
Adjustment range: 30 ... 100
in steps of 5 %
Factory setting: 30

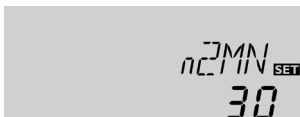

The following adjustments are used for the specific functions in system layout 8.

Reference sensors for this function are S4 and S3.

In system layout 8, the controller is equipped with an additional differential control for heat exchange from a solid fuel boiler (e.g. woodstove). The basic differential function is adjusted using the switch-on (**DT3O**) and switch-off (**DT3F**) temperature differences.

When the switch-on difference is reached, relay 2 switches on. When the temperature difference falls below the adjusted switch-off temperature difference, relay 2 switches off.



Note:

The switch-on temperature difference must be at least 0.5 K [1 °Ra] higher than the switch-off temperature difference.



Note:

For pump speed control of the solid fuel boiler pump, the operation mode of relay 2 (**MAN2**) must be set to Auto.

When the switch-on temperature difference is reached, the pump is activated at full speed for 10 seconds. Then, the speed is reduced to the minimum pump speed value (**n2MN**). If the temperature difference reaches the adjusted nominal temperature difference (**DT3S**), the pump speed increases by one step (10 %). If the difference increases by the adjustable rise value, the pump speed increases by 10 % respectively until the maximum pump speed of 100 % is reached. The response of the controller can be adapted via the parameter **RIS3**.



Note:

The nominal temperature difference must be at least 0.5 K [1 °Ra] higher than the switch-on temperature difference.

A relative minimum pump speed can be allocated to the output R2 via the adjustment channel **n2MN**.



Note:

When loads which are not speed-controlled (e.g. valves) are used, the value must be set to 100 % in order to deactivate pump speed control.

Maximum temperature limitation

MX30 / MX3F:

Maximum temperature limitation

Adjustment range:

0.0 ... 95.0 °C [30.0 ... 200.0 °F]

in steps of 0.5 °C [1 °F]

Factory setting:

MX30: 60.0 °C [140.0 °F]

MX3F: 58.0 °C [136.0 °F]

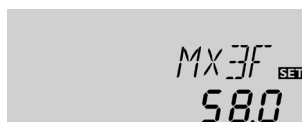
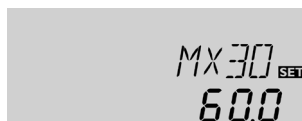

Minimum temperature limitation

MN30 / MN3F:

Minimum temperature limitation

Adjustment range:

0.0 ... 90.0 °C [30.0 ... 190.0 °F]

in steps of 0.5 °C [1 °F]

Factory setting (Arr = 8 only):

MN30: 60.0 °C [140.0 °F]

MN3F: 65.0 °C [150.0 °F]



Minimum and maximum temperature limits can be set for the solid fuel boiler.

The maximum temperature limitation function provides a maximum temperature setting, usually to reduce scald risk in a storage store. If **MX30** is exceeded, relay 2 is switched off until the sensor falls below **MX3F**. In Arr 8, this function uses sensor 3 as reference sensor.

The minimum temperature limitation uses sensor 4 as reference sensor.

The minimum temperature limitation function provides a minimum temperature setting for the solid fuel boiler in system layout 8. If the temperature at sensor 4 falls below **MN30**, relay 2 is switched off until the temperature exceeds **MN3F** again.

Both switch-on and switch-off temperature differences **DT30** and **DT3F** are valid for the maximum and minimum temperature limitation.

System layout 9

The controller calculates the temperature difference between collector sensor S1 and store sensor S2. If the difference is larger than or identical to the adjusted switch-on temperature difference (DT O), the solar pump will be operated by relay 1, and the store will be loaded until the switch-off temperature difference (DT F) or the maximum store temperature (S MX) is reached.

A heating circuit return preheating will be operated by relay 2, if the temperature difference between sensors S3 and S4 is larger than or identical to the adjusted switch-on temperature difference (DT3O). For this purpose, relay 2 will operate the 3-way-valve. S3 can optionally be used as reference sensor for the store emergency shutdown option (OSEM).

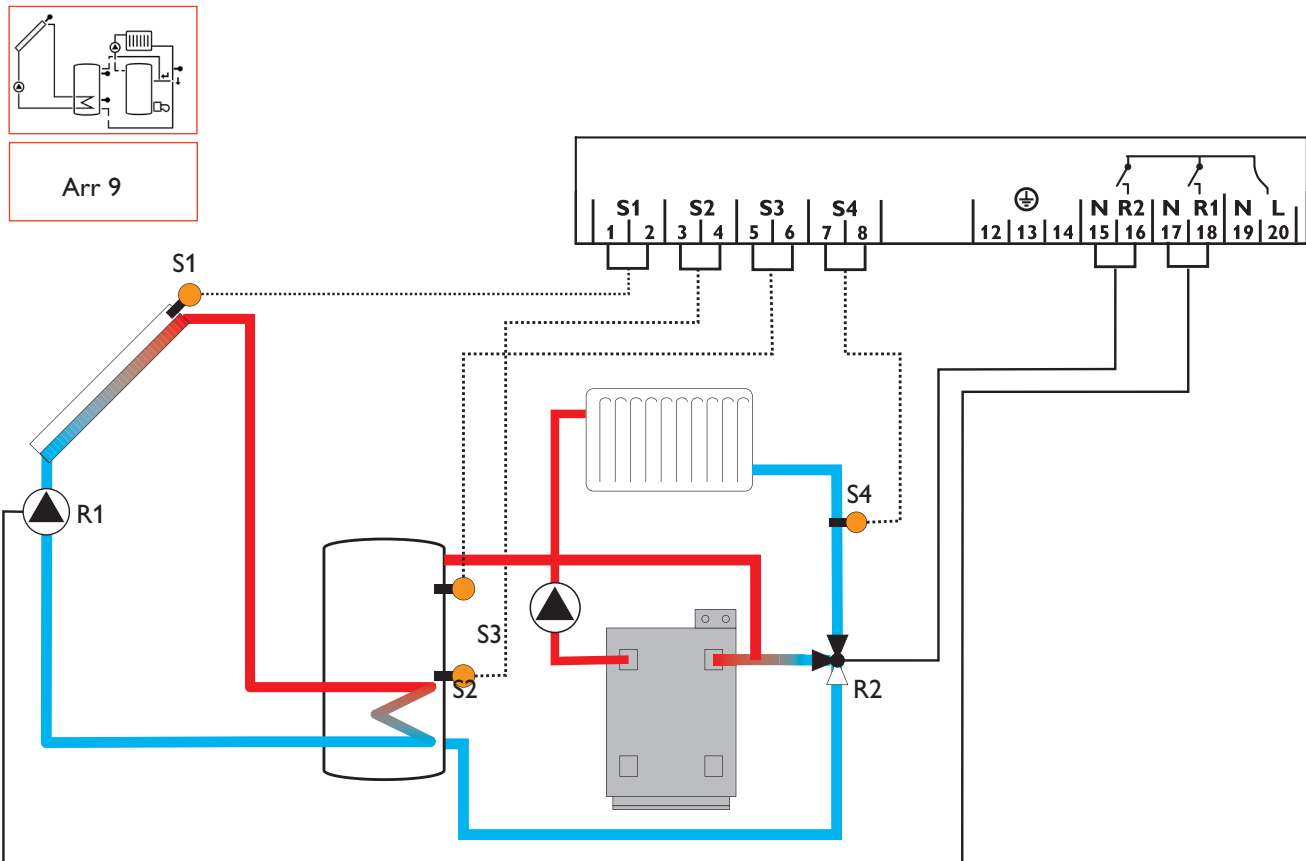

Display Channels				
Channel		Description	Terminal	Page
INIT	x*	ODB initialisation active	-	37
FLL	x*	ODB filling time active	-	37
STAB	x*	ODB stabilisation in progress	-	37
COL	x	Temperature collector	S1	37
TSTB	x	Temperature store 1 base	S2	37
TSTT	x	Temperature store 1 at the top	S3	37
TRET	x	Temperature heating circuit	S4	38
n %	x	Pump speed relay	R1	38
hP1	x	Operating hours R1	R1	38
hP2	x	Operating hours R2	R2	38
TIME	x	Time	-	34

Adjustment Channels				
Channel		Description	Factory setting	Page
Arr	x	System	9	39
DT O	x	Switch-on temperature difference	6.0 K [12.0 °Ra]	39
DT F	x	Switch-off temperature difference	4.0 K [8.0 °Ra]	39
DT S	x	Nominal temperature difference	10.0 K [20.0 °Ra]	39
RIS	x	Rise control R1	2 K [4 °Ra]	39
nMN	x	Minimum pump speed	30 %	39
S MX	x	Maximum store temperature	80 °C [176 °F]	40
OSEM	x	Option store emergency shutdown	OFF	40
EM	x	Emergency temperature collector	130 °C [270 °F]	40
		Emergency temperature collector if ODB is activated:	95 °C [200 °F]	40
OCC	x	Option collector cooling	OFF	41
CMX	x*	Maximum collector temperature	110 °C [230 °F]	41
OSYC	x	Option system cooling	OFF	41
DTCO	x*	Cooling switch-on temperature difference	20.0 K [40.0 °Ra]	41
DTCF	x*	Cooling switch-off temperature difference	15.0 K [30.0 °Ra]	41
OSTC	x	Option store cooling	OFF	42
OHOL	x*	Option holiday cooling	OFF	42
THOL	x*	Holiday cooling temperature	40 °C [110 °F]	42
OCN	x	Option minimum limitation	OFF	42
CMN	x*	Minimum collector temperature	10 °C [50 °F]	42
OCF	x	Option antifreeze	OFF	42
CFR	x*	Antifreeze temperature	4.0 °C [40.0 °F]	42
OTC	x	Option tube collector	OFF	44
TCST	x*	OTC starting time	07:00	44
TCEN	x*	OTC ending time	19:00	44
TCRU	x*	OTC runtime	30 s	44
TCIN	x*	OTC standstill interval	30 min	44
DT3O	s	Switch-on temperature difference 3	6.0 K [12.0 °Ra]	39
DT3F	s	Switch-off temperature difference 3	4.0 K [8.0 °Ra]	39
ODB	x	Drainback option	OFF	45
tDTO	x*	ODB switch-on condition - time period	60 s	45
tFLL	x*	ODB filling time	5.0 min	45
tSTB	x*	ODB stabilisation time	2.0 min	45
MAN1	x	Manual operation R1	Auto	46
MAN2	x	Manual operation R2	Auto	46
ADA1	x	HE pump control	OFF	46
LANG	x	Language	En	46
UNIT	x	Temperature unit	°C	46
RESE	x	Reset - back to factory settings		46
W005####		Version number		

Legend:

Symbol	Specification
x	Channel is available
x*	Channel is available if the corresponding option is activated.
s	Channel is specifically available in this system layout

System layout 10

The controller calculates the temperature difference between collector sensor S1 and store sensor S2. If the difference is larger than or identical to the adjusted switch-on temperature difference (DT O), the solar pump will be operated by relay 1, and the store will be loaded until the switch-off temperature difference (DT F) or the maximum store temperature (S MX) is reached.

If the maximum collector temperature (CMX) is reached, the solar pump will be operated by relay 1 and the 3-way-valve

will be operated by relay 2 in order to direct the surplus energy to a heat dump. For security purpose this will be carried out only if the store temperature is below the non-adjustable emergency shutdown of 95 °C [200 °F].

Sensors S3 and S4 can optionally be connected for measurement purposes. S3 can optionally be used as reference sensor for the store emergency shutdown option (OSEM). If heat quantity measurement (OHQM) is activated, sensor S4 has to be connected as return sensor.

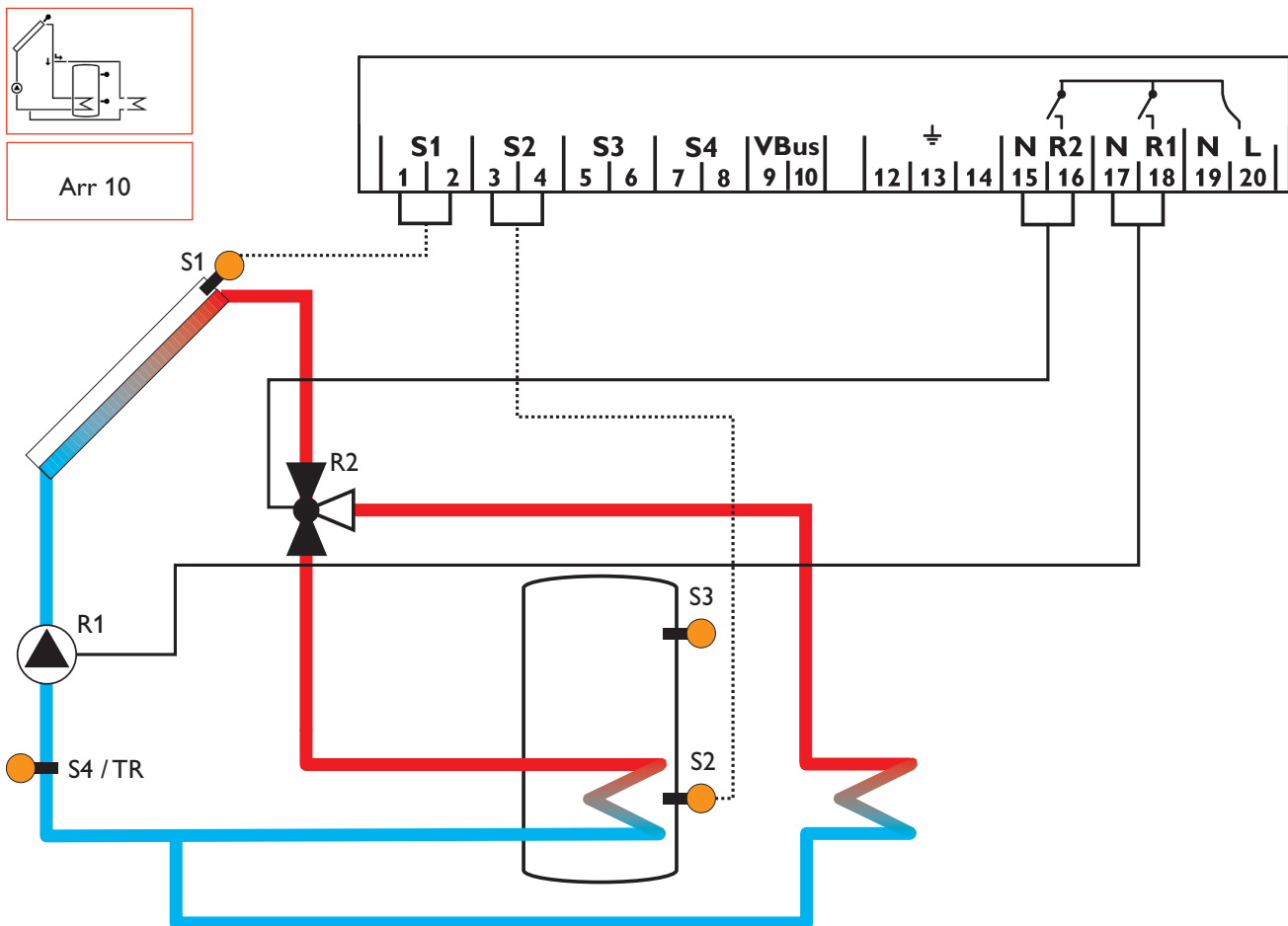

Display Channels				
Channel		Description	Terminal	Page
COL	x	Temperature collector	S1	37
TST	x	Temperature store	S2	37
S3	x	Temperature sensor 3	S3	37
TSTT	x	Temperature store at the top	S3	37
S4	x	Temperature sensor 4	S4	37
TR	x*	Temperature return sensor	S4	37
n %	x	Pump speed relay	R1	30
h P1	x	Operating hours R1	R1	38
h P2	x	Operating hours R2	R2	38
kWh	x*	Heat quantity kWh	-	38
MWh	x*	Heat quantity MWh	-	38
TIME	x	Time	-	34

Adjustment Channels				
Channel		Description	Factory setting	Page
Arr	x	System	10	39
DT O	x	Switch-on temperature difference	6.0 K [12.0 °Ra]	39
DT F	x	Switch-off temperature difference	4.0 K [8.0 °Ra]	39
DT S	x	Nominal temperature difference	10.0 K [20.0 °Ra]	39
RIS	x	Rise control R1	2 K [4 °Ra]	39
nMN	x	Minimum pump speed	30 %	39
S MX	x	Maximum store temperature	80 °C [176 °F]	40
OSEM	x	Option store emergency shutdown	OFF	40
EM	x	Emergency temperature collector	130 °C [270 °F]	40
CMX	s	Maximum collector temperature	110 °C [230 °F]	41
OCN	x	Option minimum limitation	OFF	42
CMN	x*	Minimum collector temperature	10 °C [50 °F]	42
OCF	x	Option antifreeze	OFF	42
CFR	x*	Antifreeze temperature	4.0 °C [40.0 °F]	42
OTC	x	Option tube collector	OFF	44
TCST	x*	OTC starting time	07:00	44
TCEN	x*	OTC ending time	19:00	44
TCRU	x*	OTC runtime	30 s	44
TCIN	x*	OTC standstill interval	30 min	44
OHQM	x	Option heat quantity measurement	OFF	44
FMAX	x*	Maximum flow	2.0 l	44
MEDT	x*	Antifreeze type	1	44
MED%	x*	Antifreeze concentration (only if MEDT = propylene or ethylene)	45 %	44
MAN1	x	Manual operation R1	Auto	46
MAN2	x	Manual operation R2	Auto	46
ADA1	x	HE pump control	OFF	46
LANG	x	Language	En	46
UNIT	x	Temperature unit	°C	46
RESE	x	Reset - back to factory settings		46
W005####		Version number		

Legend:

Symbol	Specification
x	Channel is available
x*	Channel is available if the corresponding option is activated.
s	Channel is specifically available in this system layout

2. Operation and function

2.1 Push buttons

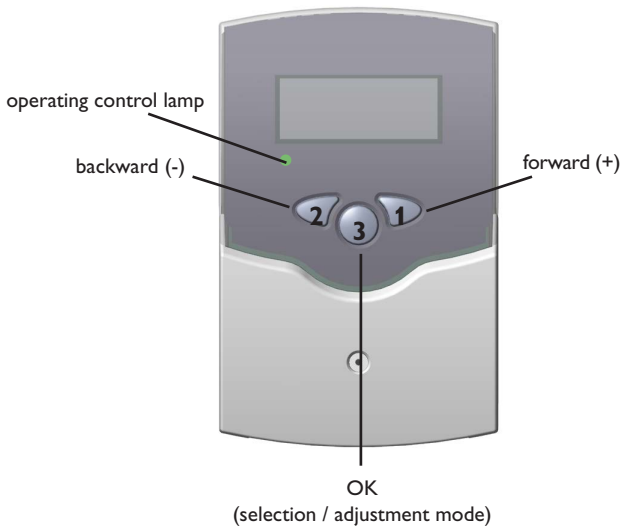

The controller is operated via three push buttons below the display.

Button 1 is used for scrolling forward through the indication menu or to increase the adjustment values. **Button 2** is used for scrolling backward and reducing values. **Button 3** is used for selecting channels and confirming adjustments. During normal operation, only the display channels are shown.

→ Scroll through the display channels by pressing buttons 1 and 2

Accessing the adjustment channels:

→ Scroll down in the display menu and press button 1 for approx. two seconds after you have reached the last display item.

When an **adjustment value** is shown on the display, **SET** is indicated to the right of the channel name.

→ Press button 3 in order to access the adjustment mode **SET** starts flashing.

→ Adjust the value using buttons 1 and 2

→ Briefly press button 3, **SET** permanently appears, the adjusted value will be saved.

2.2 System-Monitoring-Display

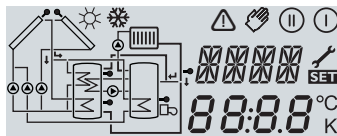

system monitoring display

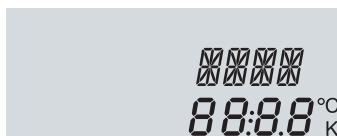

channel display

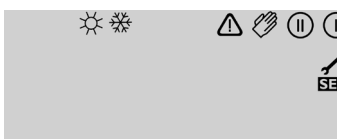

tool bar

The system monitoring display consists of three blocks: **channel display**, **tool bar** and **system screen** (active system layout).

The **channel display** consists of two lines. The upper line is an alpha-numeric 16-segment display (text display) for displaying channel names and menu items. In the lower 7-segment display, the channel values and the adjustment parameters are displayed.

Temperatures are either indicated in °C or °F, whereas temperature differences are indicated in K or °Ra respectively. The additional symbols of the **tool bar** indicate the current system status.

Status	standard	flashing
relay 1 active	ⓘ	
relay 2 active	ⓘ	
maximum store temperature exceeded	☀	
store emergency shutdown active		⚠ + ☀
collector emergency shutdown active		⚠
collector cooling active	ⓘ	☀
system cooling active	ⓘ	☀
store cooling active	ⓘ + ☀	
holiday cooling function activated	☀	⚠
holiday cooling function active	ⓘ + ☀	⚠
collector minimum limitation active		❄
antifreeze function activated	❄	
antifreeze function active	ⓘ / ⓘ	❄
manual operation relay 1 ON	☞ + ⓘ	⚠
manual operation relay 2 ON	☞ + ⓘ	⚠
manual operation relay 1 / 2 OFF	☞	⚠
sensor defective	🔧	⚠

System screen

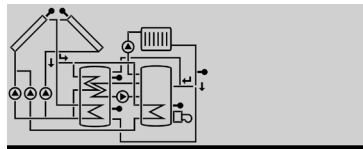

system screen

The system screen (active system layout) shows the system selected on the controller. It consists of several system component symbols, which are – depending on the current status of the system – either flashing, permanently shown or hidden.

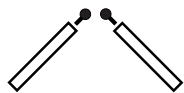
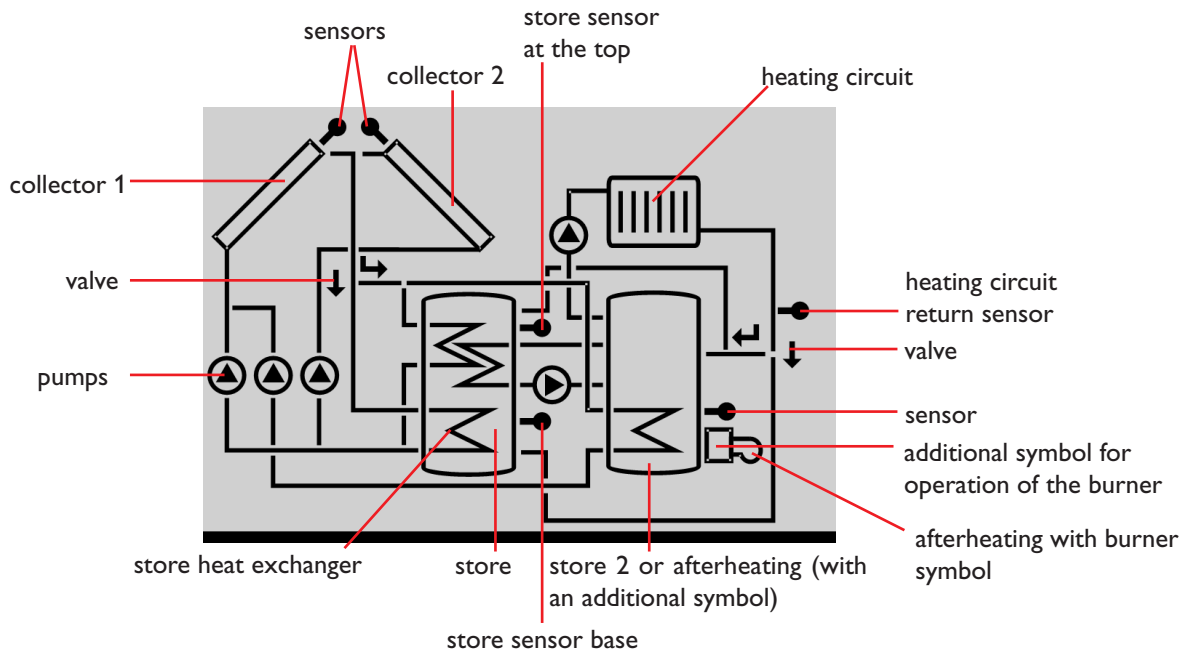

Collectors
with collector sensor

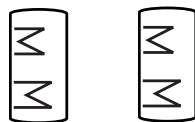

Stores 1 and 2
with heat exchanger



3-way valve
the flow direction or the current switching position is shown



Temperature sensor



Heating circuit



Pump

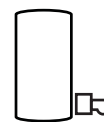

Afterheating
with burner symbol

2.3 Flashing codes

System screen flashing codes

- Pumps are flashing when the corresponding relay is switched on
- Sensor symbols are flashing if the corresponding sensor display channel is selected
- Sensors are flashing quickly in the case of a sensor fault
- Burner symbol is flashing if the afterheating is active

LED flashing codes

- | | |
|---------------------|-------------------------------------|
| green: | everything OK |
| red/green flashing: | initialisation phase |
| red flashing: | manual operation |
| | sensor fault |
| | (sensor symbol is flashing quickly) |

3. Commissioning

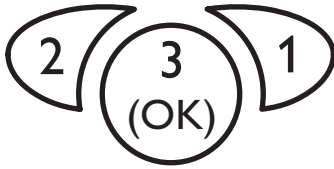

The three push buttons of the BS Plus controller

→ Establish the power supply
 During a short initialisation phase, the operating control lamp flashes red and green.

When the controller is commissioned for the first time or after a reset, it will run a commissioning menu. The commissioning menu leads the user through the most important adjustment channels needed for operating the system.

Operating the commissioning menu:

- Enter the channel by pressing button 3
 The **SET** symbol flashes.
- Adjust the value by pressing buttons 1 and 2
- Save the adjustment by pressing button 3 again
 The **SET** symbol stops flashing.
- Press button 1 or 2 to switch to the next or previous channel

The commissioning menu consists of the following 6 channels:

LANG:

Language selection
 Selection: dE,En,Fr
 Factory setting: En



1. Language

- Adjust the desired menu language in this channel
- dE : German
- En : English
- Fr : French

UNIT:

Temperature unit selection
 Selection: °C, °F
 Factory setting: °C



2. Unit

- Adjust the unit in which temperatures and temperature differences shall be displayed

TIME:

Real time adjustment

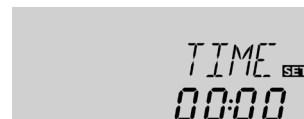

3. Time

- Adjust the current time for the real time clock
 The hours and minutes have to be adjusted separately, first the hours, then the minutes.

Arr:

System layout selection
Adjustment range: 1 ... 10
Factory setting: 1



4. System layout

→ Adjust the desired system layout of your solar thermal system

For a detailed description of the different system layouts selectable, see chapter 1.4.

Overview of system layouts:

Arr 1 : standard solar system layout

Arr 2 : solar system layout with heat exchange

Arr 3 : solar system layout with afterheating

Arr 4 : solar system layout with vertical store charging

Arr 5 : 2-store solar system layout with valve logic

Arr 6 : 2-store solar system layout with pump logic

Arr 7 : solar system layout with 2 collectors and 1 store

Arr 8 : solar system layout with afterheating by solid fuel boiler

Arr 9 : solar system layout with heating circuit return preheating

Arr 10: standard solar system layout with heat dump

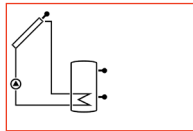

Arr 1

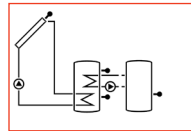

Arr 2

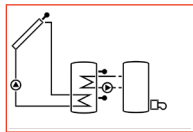

Arr 3

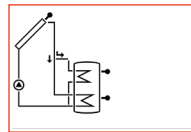

Arr 4

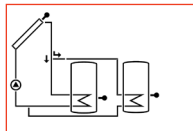

Arr 5

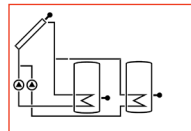

Arr 6

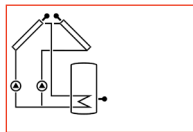

Arr 7

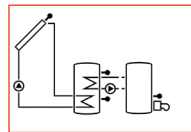

Arr 8

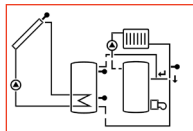

Arr 9

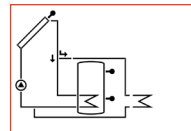

Arr 10

If the system layout selection is changed later on, any previous adjustments which have been made in the other channels will be lost. Therefore, changing the system layout is always followed by a security enquiry.

Only confirm the security enquiry if you are sure that you wish to change the system layout selection!

Security enquiry:

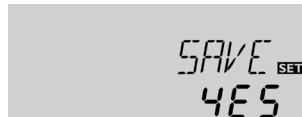

→ To confirm the security enquiry, press button 3

S MX / S1MX / S2MX:

Maximum store temp.
 Adjustment range:
 4 ... 95 °C [40 ... 200 °F]
 Arr 10:
 4 ... 90 °C [40 ... 190 °F]
 in steps of 1 °C [2 °F]
 Factory setting: 80 °C [176 °F]

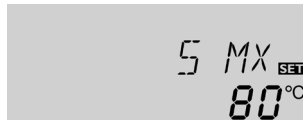

5. Maximum store temperature

→ Adjust the desired maximum store temperature



Note:

The controller is also equipped with a non-adjustable emergency shutdown function, which will shut the system down if the store reaches 95 °C [200 °F].

nMN, n1MN, n2MN:

Pump speed control
 Adjustment range: 30...100
 in steps of 5 %
 Factory setting: 30

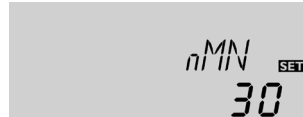

6. Minimum pump speed

→ Adjust a minimum speed for the pump



Note:

If loads which are not speed-controlled (e.g. valves) are used, the value must be set to 100% for the respective relay.

Confirmation enquiry

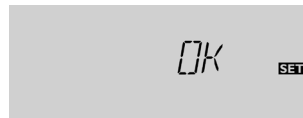

Completing the commissioning menu

After the last channel of the commissioning menu has been adjusted and confirmed, the controller asks for confirmation of the adjustments.

→ To confirm the adjustments made in the commissioning menu, press button 3

Now the controller is ready for operation with typical settings to suit the selected system layout.

The settings made in the commissioning menu can be changed later on in the corresponding adjustment channels. Additional functions and options can of course be individually adjusted as well (see chap. 4.2).

4. Channel overview

4.1 Display channels

Indication of drainback time periods

Initialisation

INIT:
ODB initialisation active



Note:

The displayed values and adjustment channels depend on which system layout, which options and functions have been selected. Only values and adjustment channels available for the individual settings selected will appear in the menu.

Indicates the time adjusted in **tD_{TO}**, running backwards.

Filling time

FLL:
ODB filling time active



Indicates the time adjusted in **tF_{LL}**, running backwards.

Stabilisation

STAB:
Stabilisation

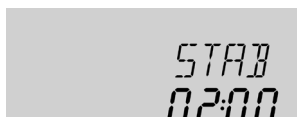

Indicates the time adjusted in **tS_{TB}**, running backwards.

Indication of collector temperatures

COL, COL1, COL2:
Collector temperature
Display range:
-40...+260 °C [-40...+500 °F]

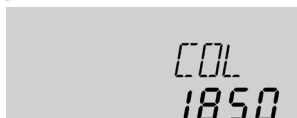

Indicates the current collector temperature.

- COL : collector temperature (1-collector system)
- COL1: collector temperature 1
- COL2: collector temperature 2

Indication of store temperatures

TST, TSTB, TSTT, TST1, TST2, TDIS:
Store temperatures
Display range:
-40...+260 °C [-40...+500 °F]

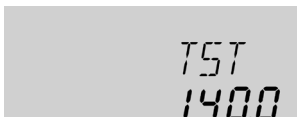

Indicates the current store temperature.

- TST : store temperature (1-store system)
- TSTB: store temperature base
- TSTT: store temperature top
- TST1 : temperature store 1 (2-store-systems)
- TST2 : temperature store 2 (2-store-systems)
- TDIS : thermal disinfection temperature (Arr = 3 only; replaces TSTT if, during thermal disinfection, the heating period DDIS is active)

Indication of sensors 3 and 4

S3, S4:
Sensor temperatures
Display range:
-40...+260 °C [-40...+500 °F]

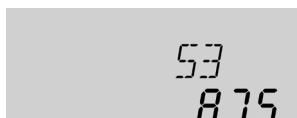

Indicates the current temperature of the corresponding additional sensor (without control function).

- S_t: temperature sensor 4



Note:

S3 and S4 will only be indicated if the temperature sensors are connected.

Indication of other temperatures

TSFB, TRET, TR:
Other measured temperatures
Display range:
-40...+260 °C [-40...+500 °F]

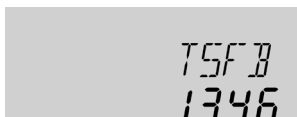

Indicates the current temperature of the corresponding sensor.

- TSFB : temperature solid fuel boiler
- TRET : temperature heating return preheating
- TR : temperature return

Indication of current pump speed

n % , n1 % , n2 %:
Current pump speed
Display range: 30 ...100 %



kWh/MWh: Heat quantity
in kWh / MWh
Display channel



Indicates the current pump speed of the corresponding pump.

- n % : current pump speed (1-pump system)
- n1 % : current pump speed pump 1
- n2 % : current pump speed pump 2

Indicates the energy gained in heat quantity – only available if heat quantity measurement (OHQM) is activated.

The flow rate as well as the reference sensors S1 (flow) and S4 (return) are used for calculating the heat quantity supplied. It is shown in kWh in the channel **kWh** and in MWh in the channel **MWh**. The overall heat quantity results from the sum of both values.

The accumulated heat quantity can be set back to 0. As soon as one of the display channels of the heat quantity is selected, the **SET** symbol is permanently shown on the display.

→ Press button 3 for about two seconds in order to access the RESET mode of the counter.

The display symbol **SET** will flash and the heat quantity value will be set to 0.

→ Confirm the reset with button 3 in order to finish the reset.

In order to interrupt the RESET-process, do not press a button for about five seconds. The display returns to the display mode.

If the thermal disinfection option (**OTD**) is activated and the monitoring period is in progress, the remaining monitoring time will be displayed as **CDIS** (in days and hours) and counted backwards.

If the thermal disinfection option (**OTD**) is activated and a starting delay time has been adjusted, the adjusted delay time is displayed (flashing) in this channel.

If the thermal disinfection option (**OTD**) is activated and the heating period is in progress, the remaining time of the heating period is displayed (in hours and minutes) in this channel, counting backwards.

Indicates the current time.

→ Press button 3 for two seconds to adjust the hours

→ Set the hours by pressing buttons 1 and 2

→ Press button 3 again to adjust the minutes

→ Set the minutes by pressing buttons 1 and 2

→ Press button 3 in order to save the adjustments

The operating hours counter accumulates the solar operating hours of the respective relay (**h P / h P1 / h P2**). Full hours are displayed.

The accumulated operating hours can be set back to zero. As soon as one operating hours channel is selected, the symbol **SET** is displayed.

→ In order to access the RESET-mode of the counter, press button 3 for approx. two seconds.

The display symbol **SET** will flash and the operating hours will be set to 0.

→ Confirm the reset with button 3 in order to finish the reset.

In order to interrupt the RESET-process, do not press a button for about five seconds. The display returns to the display mode.

CDIS

Countdown of monitoring period
Display range:
0 ... 30:0 ... 24 (dd:hh)

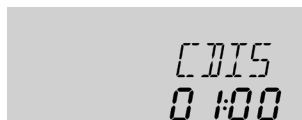

SDIS

Starting time display
Display range:
00:00 ... 24:00 (hh:mm)



DDIS

Heating period display
Display range:
00:00 ... 24:00 (hh:mm)

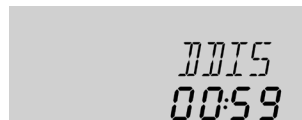

TIME

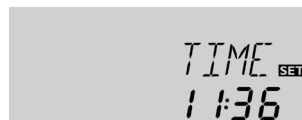

Operating hours counter

h P / h P1 / h P2:
Operating hours counter
Display channel

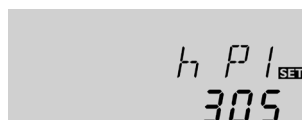

4.2 Adjustment channels

System layout selection

Arr:

System layout selection.
Adjustment range: 1 ... 10
Factory setting: 1



Security enquiry:

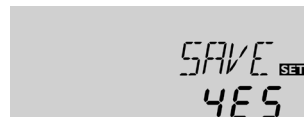

ΔT-regulation

DT O / DT10 / DT20 / DT30:

Switch-on temperature diff.
Adjustment range:
1.0 ... 20.0 K [2.0 ... 40.0 °Ra]
in steps of 0.5 K [1 °Ra]
Factory setting:
6.0 K [12.0 °Ra]

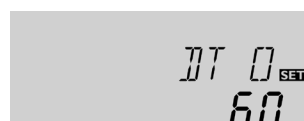

DT F / DT1F / DT2F / DT3F:

Switch-off temperature diff.
Adjustment range:
0.5 ... 19.5 K [1.0 ... 39.0 °Ra]
in steps of 0.5 K [1 °Ra]
Factory setting:
4.0 K [8.0 °Ra]



Pump speed control

DT S / DT1S / DT2S / DT3S:

Nominal temperature difference
Adjustment range:
1.5 ... 30.0 K [3.0 ... 60.0 °Ra]
in steps of 0.5 K [1 °Ra]
Factory setting:
10.0 K [20.0 °Ra]



RIS / RIS1 / RIS2 / RIS3:

Rise
Adjustment range:
1 ... 20 K [2 ... 40 °Ra]
in steps of 1 K [2 °Ra]
Factory setting: 2 K [4 °Ra]



Minimum pump speed nMN, n1MN, n2MN:

Pump speed control
Adjustment range: 30 ... 100 %
in steps of 5 %
Factory setting: 30 %
nMN, n1MN, if ODB is activated:
50 %

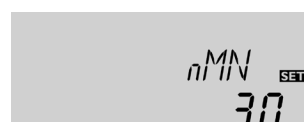

In this channel, a pre-defined system layout can be selected. Each system layout has a set of pre-programmed settings that can be individually changed.

If the system layout selection is changed later on, all adjustments made in the other channels will be lost. Therefore, changing the system layout is always followed by a security enquiry.

Only confirm the security enquiry if you are sure that you wish to change the system layout selection!

➔ To confirm the security enquiry, press button 3

The controller works as a standard differential controller. If the switch-on difference is reached, the pump is activated. When the temperature difference falls below the adjusted switch-off temperature difference, the respective relay switches off.



Note:

The switch-on temperature difference must be at least 0.5 K [1 °Ra] higher than the switch-off temperature difference.



Note:

When the drainback option **ODB** is activated, the temperature differences **DT O**, **DT F** and **DT S** are set to a fixed adjustment:

DT O = 10 K [20 °Ra]

DT F = 4 K [8 °Ra]

DT S = 15 K [30 °Ra]

Previous adjustments made in these channels will be overridden and may have to be entered again if **ODB** is deactivated later on.



Note:

For pump speed control, the operation mode of the corresponding relay must be set to Auto (adjustment channel **MAN1** / **MAN2**)

When the switch-on temperature difference is reached, the pump is activated at full speed for 10 seconds. Then, the speed is reduced to the minimum pump speed value (factory setting = 30 %).

If the temperature difference reaches the adjusted nominal temperature difference, the pump speed increases by one step (10 %). If the difference increases by the adjustable rise value, the pump speed increases by 10 % respectively until the maximum pump speed of 100 % is reached. The response of the controller can be adapted via the parameter "Rise".



Note:

The nominal temperature difference must be at least 0.5 K [1 °Ra] higher than the switch-on temperature difference.

A relative minimum pump speed can be allocated to the outputs R1 and R2 via the adjustment channels **nMN**, **n1MN** and **n2MN**.



Note:

When loads which are not speed-controlled (e.g. valves) are used, the value must be set to 100 % in order to deactivate pump speed control.

Maximum store temperature

S MX / S1MX / S2MX:

Maximum store temp.

Adjustment range:

4 ... 95 °C [40 ... 200 °F]

Arr 10:

4 ... 90 °C [40 ... 190 °F]

in steps of 1 °C [2 °F]

Factory setting: 80 °C [176 °F]



Once the adjusted maximum temperature is exceeded, the solar pump is switched off and further loading of the store is prevented to reduce scald risk or system damage. A fixed hysteresis of 2 K [4 °Ra] is set for the maximum store temperature.

When the temperature at the corresponding sensor exceeds the adjusted maximum store temperature, the symbol is shown on the display.



Note:

If the collector cooling or the system cooling function is activated, the adjusted store temperature may be overridden. In order to prevent system damage, the controller is also equipped with an integrated store emergency shutdown if the store reaches 95 °C [200 °F].

Store emergency shutdown option

OSEM

Store emergency shutdown option

Adjustment range: OFF/ON

Factory setting: OFF

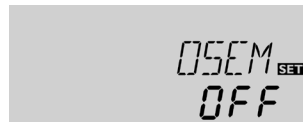

This option is used for activating the integrated store emergency shutdown for an upper store sensor. If the temperature at the reference sensor exceeds 95 °C, store 1 will be blocked and loading will be stopped until the temperature falls below 90 °C.



Note:

Sensor S3 is used as the reference sensor in the system layouts 1, 2, 3, 8, 9 and 10. In the system layouts 6 and 7, sensor S4 is used as the reference sensor.

This option is not available in system layouts 4 and 5.

Collector temperature limitation

Emergency shutdown of the collector

EM / EM1 / EM2:

Collector temperature limitation

Adjustment range:

80 ... 200 °C

[170 ... 390 °F]

in steps of 1 °C [2 °F]

Factory setting:

130 °C [270 °F]



If the adjusted collector emergency shutdown temperature (**EM / EM1 / EM2**) is exceeded, the controller switches off the solar pump (R1 / R2) in order to protect the system against overheating (collector emergency shutdown). A hysteresis of 10 K [20 °Ra] is set for the collector temperature limitation. While the collector is in emergency shutdown, (flashing) is shown on the display.



Note:

If the drainback option **ODB** is activated, the adjustment range of **EM** is changed to 80 ... 120 °C [170 ... 250 °F]. The factory setting in that case is 95 °C [200 °F].

WARNING!



Danger of injury and system damage through pressure surges!

If water is used as a heat transfer medium in a pressure-less system, the water will start boiling at 100 °C [212 °F].

→ If a pressure-less drainback system is used with water as a heat transfer medium, do not adjust the collector temperature limitation **EM** to more than 95 °C [200 °F]!

Cooling functions

Collector cooling function

OCC / OCC1 / OCC2:

Option collector cooling
Adjustment range: OFF/ON
Factory setting: OFF

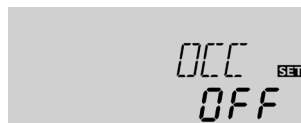

CMX / CMX1 / CMX2:

Maximum collector temp.
Adjustment range:
70 ... 160 °C
[150...320 °F]
in steps of 1 °C [1 °F]
Factory setting:
110 °C [230 °F]



System cooling function

OSYC:

Option system cooling
Adjustment range: OFF/ON
Factory setting: OFF



DTCO:

Switch-on temperature diff.
Adjustment range:
1.0 ... 30.0 K [2.0 ... 60.0 °Ra]
in steps of 0.5 K [1 °Ra]
Factory setting:
20.0 K [40.0 °Ra]

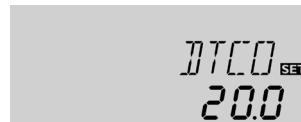

DTCF:

Switch-off temperature diff.
Adjustment range:
0.5 ... 29.5 K [1.0 ... 59.0 °Ra]
in steps of 0.5 K [1 °Ra]
Factory setting:
15.0 K [30.0 °Ra]

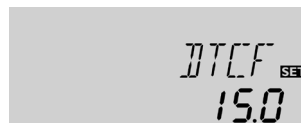

In the following the three cooling functions – collector cooling, system cooling and store cooling – are described in detail. The following notes are valid for all three cooling functions:



Note:

The cooling functions will not become active as long as solar loading is possible.



Note:

In 2-store-systems, the cooling functions will only affect store 1, respectively the base area of the store (such as in Arr = 4).

When the collector cooling function is activated, the controller aims to keep the collector at an operational temperature. When the adjusted maximum store temperature is reached, solar loading stops. If the collector temperature increases to the adjusted maximum collector temperature, the solar pump is activated until the collector temperature falls at least 5 K [10 °Ra] below the maximum collector temperature. The store temperature may increase (subordinate active maximum store temperature), but only up to 95 °C [200 °F] (emergency shutdown of the store).

If the collector cooling function is active, and (flashing) is shown on the display.



Note:

This function will only be available if the system cooling function (**OSYC**) is deactivated.



Note:

In system layout 10, the parameter **CMX** is available without the **OCC** function. In system layout 10, **CMX** is used to set the activation temperature for the heat dump function. No other switch-on condition is needed in that case.

When the system cooling function is activated, the controller aims to keep the solar system operational for a longer time. The function overrides the maximum store temperature to provide thermal relief of the collector field and the heat transfer fluid on hot days.

If the store temperature is higher than the maximum store temperature (**S MX / S1MX**) and the switch-on temperature difference **DTCO** is reached, the solar system remains activated. Solar loading is continued until either the store temperature reaches 95 °C [200 °F] (emergency shutdown of the store), the temperature difference falls below the adjusted value **DTCF** or the collector emergency shutdown temperature **EM** is reached.

If the system cooling function is active, and (flashing) is shown on the display.



Note:

This function will only be available if the collector cooling function (**OCC**) is deactivated.

Store cooling function

OSTC:

Store cooling option
Adjustment range: OFF/ON
Factory setting: OFF



OHOL:

Holiday cooling option
Adjustment range: OFF/ON
Factory setting: OFF

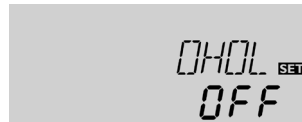

THOL:

Holiday cooling temperature
Adjustment range:
20 ... 80 °C [70 ... 175 °F]
in steps of 1 °C [1 °F]
Factory setting:
40 °C [110 °F]



When the store cooling function is activated, the controller aims to cool down the store during the night in order to prepare it for solar loading on the following day.

If the adjusted maximum store temperature (**S MX / S1MX**) is exceeded and the collector temperature falls below the store temperature, the system will be reactivated in order to cool down the store. Cooling will continue until the store temperature has fallen below the adjusted maximum store temperature (**S MX / S1MX**) again. A fixed hysteresis of 2 K [4 °Ra] is set for this function.

Reference threshold temperature differences for the store cooling function are **DT O** and **DT F**.

If no DHW consumption is expected for a longer period of time, the additional holiday cooling option **OHOL** can be activated in order to extend the store cooling function. The adjustable temperature **THOL** then replaces the maximum store temperature (**S MX / S1MX**) as a switch-off temperature for the store cooling function.

When the holiday cooling function is activated, ☀ and ⚠ (flashing) are shown on the display.

While the holiday cooling function is active, ⌚, ☀ and ⚠ (flashing) are shown on the display.

Collector minimum limitation option

OCN / OCN1 / OCN2:

Collector minimum limitation
Adjustment range: OFF/ON
Factory setting: OFF



CMN / CMN1 / CMN2:

Collector minimum temp.
Adjustment range:
10.0 ... 90.0 °C [50.0 ... 190.0 °F]
in steps of 0.5 °C [1.0 °F]
Factory setting:
10.0 °C [50.0 °F]



If the collector minimum limitation option is activated, the pump (R1 / R2) is only switched on if the adjustable collector minimum temperature is exceeded. The minimum temperature prevents the pump from being switched on too often at low collector temperatures. A fixed hysteresis of 5 °K [10 °Ra] is set for this function.

If the collector minimum limitation is active, ❄ (flashing) is shown on the display.



Note:

If **OSTC** or **OCF** is active, the collector minimum function will be overridden. In that case, the collector temperature may fall below **CMN**.

Antifreeze option

OCF / OCF1 / OCF2:

Antifreeze function
Adjustment range: OFF / ON
Factory setting: OFF



CFR / CFR1 / CFR2:

Antifreeze temperature
Adjustment range:
-40.0 ... +10.0 °C
[-40.0 ... +50.0 °F]
in steps of 0.5 °C [1 °F]
Factory setting:
4.0 °C [40.0 °F]



The antifreeze function activates the loading circuit between the collector and the store when the temperature falls below the adjusted antifreeze temperature. This will protect the fluid against freezing or coagulating. If the adjusted antifreeze temperature is exceeded by 1 K [2 °Ra], the loading circuit will be deactivated.

When the antifreeze function is activated, ❄ is shown on the display. If the antifreeze function is active, ⌚ and ❄ (flashing) are shown on the display.



Note:

Since this function uses the limited heat quantity of the store, the antifreeze function should be used in regions with few days of temperatures around the freezing point.

The antifreeze function will be suppressed if the store temperature falls below 5 °C [40 °F] in order to protect the store from frost damage.

Priority logic



Note:

Priority logic can be used in multi-store system layouts only (Arr = 4, 5, 6).

PRIO:

Loading priority

Adjustment range:

SE 1, SE 2, Su 1, Su 2, 0, 1, 2

Factory setting:

Arr 4: 2

Arr 5, 6: 1



Note:

If the priority is set to **Su 1** or **Su 2**, solar loading of the subordinate store will be aborted at once if the temperature in the priority store (store 1 for Su 1, store 2 for Su 2) falls below the adjusted maximum temperature. If, in that case, the temperature difference between the priority store and the collector is not sufficiently high, solar loading will be stopped completely.

Spreaded loading temperature difference

(only available if PRIO is set to SE 1 or SE 2)

DTSE:

Spread temperature difference

Adjustment range:

20 ... 90 K [40 ... 160 °Ra]

in steps of 1 K [1 °Ra]

Factory setting: 40 K [70 °Ra]



Store sequence control

(only available if priority is set to SE 1, SE 2, 1 or 2)

tLB:

Loading break time

Adjustment range: 1 ... 30 min

Factory setting: 2 min



tRUN:

Loading runtime

Adjustment range: 1 ... 30 min

Factory setting: 15 min



If a multi-store system layout has been chosen, the priority logic determines how the heat is divided between the stores. Different types of priority logic are adjustable:

- spreaded loading (SE 1 and SE 2)
- successive loading (Su 1 and Su 2)
- parallel loading (0)
- store sequence control (1 and 2)

If **priority SE 1** or **SE 2** (only available in Arr 6) is adjusted, the subordinate store will be loaded in parallel if the temperature difference between the collector and the priority store (store 1 for SE 1, store 2 for SE 2) exceeds the adjusted value **DTSE** and the subordinate store has not reached its maximum temperature.

Parallel loading will stop as soon as the temperature difference between the collector and the priority store falls 2 K [4 °Ra] below **DTSE** or the subordinate store reaches its maximum temperature.

If **priority Su 1** or **Su 2** is adjusted, the stores are loaded successively. The subordinate store will only be loaded if the priority store (store 1 for Su 1, store 2 for Su 2) has reached its adjusted maximum temperature (**S1MX** or **S2MX**).

If **priority 0** is adjusted and the switch-on conditions are fulfilled for both stores, the stores are loaded in parallel (Arr 6), resp. in an oscillating loading (Arr 4, 5) beginning with the store with the lowest temperature. In an oscillating loading, solar loading will switch from one store to the other in steps of 5 K [10 °Ra] temperature difference between the stores.

If **priority 1 / 2** is adjusted, store sequence control will be activated (see below) with the corresponding store as priority store.

Store sequence control will be activated when **PRIO** is set to SE 1, SE 2, 1 or 2.

If the priority store cannot be loaded, the subordinate store is checked. If useful heat can be added, it will be loaded for the "loading runtime time" (**tRUN** - factory setting 15 min.) After this, the loading process stops and the controller monitors the increase in collector temperature during the loading break time **tLB**. If it increases by 2 K [4 °Ra], the break time timer starts again to allow the collector to gain more heat. If the collector temperature does not increase sufficiently, the subordinate store will be loaded again for the **tRUN** time as before.

As soon as the switch-on condition of the priority store is fulfilled, it will be loaded. If the switch-on condition of the priority store is not fulfilled, loading of the second store will be continued. If the priority store reaches its maximum temperature, sequence controlled loading will not be carried out.

If store sequence control is active and the system switches to load the priority store, the parameter **tLB** also acts as a stabilisation timer; during which the switch-off condition **DTF** is ignored while the system operation stabilises.

Tube collector function

OTC:

Tube collector function
Adjustment range: OFF/ON
Factory setting: OFF



TCST:

Tube collector function
starting time
Adjustment range:
00:00...23:45
in steps of 00:15
Factory setting: 07:00



TCEN:

Tube collector function
ending time
Adjustment range:
00:00...23:45
in steps of 00:15
Factory setting: 19:00



TCRU:

Tube collector function
runtime
Adjustment range: 5 ... 500 s
in steps of 5 s
Factory setting: 30 s



TCIN:

Tube collector function
standstill interval
Adjustment range: 1 ... 60 min
in steps of 1 min
Factory setting: 30 min



This function helps overcome the disadvantages caused by the non-ideal sensor position with some tube collectors.

This function operates within an adjusted time frame (beginning at **TCST** and ending at **TCEN**). It activates the collector circuit pump for an adjustable runtime (**TCRU**) between adjustable standstill intervals (**TCIN**) in order to compensate for the delayed temperature measurement.

If the runtime **TCRU** is set to more than ten seconds, the pump will be run at 100 % for the first ten seconds of the runtime. For the remaining runtime, the pump will be run at the adjusted minimum speed **nMN**.

If the collector sensor is defective or the collector is blocked, this function is suppressed or switched off.

In system layout 7 (Arr = 7) both collectors are operated independently from each other by means of this function. If the store is being loaded by one collector, the other one is nevertheless operated after the adjusted standstill time.



Note:

If the drainback option **ODB** is activated, **TCRU** will not be available. In that case, the runtime is determined by the parameters **tFLL** and **tSTB**.

WARNING!



Danger of injury and system damage through pressure surges!

If a drainback system is filled due to the tube collector function and the heat transfer medium enters very hot collectors, pressure surges can occur.

→ If a pressure-less drainback system is used, **TCST** and **TCEN** must be adjusted such that the system will not be filled during times of potentially strong irradiation!

Heat quantity measurement

OHQM: Heat quantity measurement

Adjustment range: OFF/ON
Factory setting: OFF

FMAX: Flow rate in l/min
Adjustment range: 0.5 ... 100.0
in steps of 0.5
Factory setting: 2.0



MEDT: Heat transfer fluid
Adjustment range: 0...3
Factory setting: 1



MED%: Antifreeze ratio
in Vol-% (MED% is hidden
when MEDT 0 or 3 is used.)
Adjustment range: 20 ... 70 %
in steps of 1 %
Factory setting: 45 %



If OHQM is activated, the heat quantity gained can be calculated and displayed. Heat quantity measurement is possible on Arr. 1, 3, 4, 5 and 10 if a flowmeter is used. To enable heat quantity measurement, proceed as follows:

- Read the flow rate (l/min) from the flowmeter at maximum pump speed and adjust it in the **FMAX** channel
- Adjust the heat transfer fluid and the concentration of the antifreeze in the channels **MEDT** and **MED%**.

Heat transfer fluid:

- 0 : Water
- 1 : Propylene glycol
- 2 : Ethylene glycol
- 3 : Tyfocor® LS / G-LS



Note:

If the system layout 10 has been selected and **OHQM** is activated, heat quantity measurement will be interrupted when the 3-way-valve switches to the heat dump.

Drainback option



Note:

A drainback system layout requires additional components such as a holding tank. The drainback option should only be activated if all components required are properly installed.



Note:

The drainback option is only available in system layouts with one store and one collector (Arr 1, 2, 3, 8 and 9).

ODB:

Drainback option

Adjustment range: OFF/ON

Factory setting: OFF

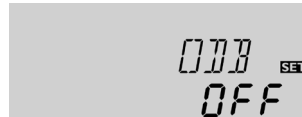

Note:

When the drainback option **ODB** is activated, the cooling functions **OCC**, **OSYC** and **OSTC** as well as the antifreeze function **OCF** are not available.

If **OCC**, **OSYC**, **OSTC** or **OCF** have already been activated before, they will be deactivated again as soon as **ODB** is activated. They will remain deactivated, even if **ODB** is deactivated later on.

A drainback system permits the heat transfer fluid to drain back into the holding tank when solar energy is not collected. The drainback option will initiate the filling of the system when solar loading begins.

If the drainback option **ODB** is activated, the pump will operate at 100 % speed for the adjusted filling time **tFLL** in order to fill the system with fluid from the holding tank. After **tFLL**, pump speed will go down to the adjusted minimum pump speed **nMn**. The switch-off conditions will then be ignored for the stabilisation time **tSTB** in order to avoid the system from shutting down prematurely.

If the function is activated, the menu items described in the following (**tDTO**, **tFLL** and **tSTB**) have to be adjusted:



Note:

When the drainback option **ODB** is activated, the temperature differences **DT O**, **DT F** and **DT S** as well as the minimum speed values **nMN/n1MN** are set to a fixed adjustment. Additionally, the adjustment range and the factory setting of the collector emergency shutdown temperature **EM** changes (see the corresponding channel descriptions for further information).

Previous adjustments made in these channels will be overridden and have to be entered again if **ODB** is deactivated later on.

Time period - switch-on conditions

tDTO:

Time period - switch-on conditions

Adjustment range: 1 ... 100 s

in steps of 1 s

Factory setting: 60 s

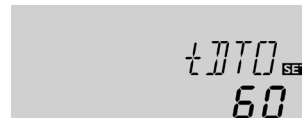

The parameter **tDTO** is used for adjusting the time period during which the switch-on condition **DT O** must be permanently fulfilled.

Filling time

tFLL:

Filling time

Adjustment range:

1.0 ... 30.0 min

in steps of 0.5 min

Factory setting: 5.0 min

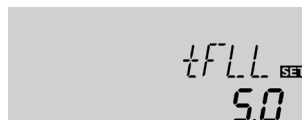

The filling time can be adjusted using the parameter **tFLL**. During this period, the pump runs at 100 % speed.

Stabilisation

tSTB:

Stabilisation

Adjustment range:

1.0 ... 15.0 min

in steps of 0.5 min

Factory setting: 2.0 min

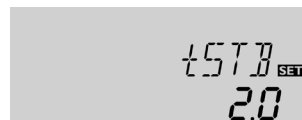

The parameter **tSTB** is used for adjusting the time period during which the switch-off condition **DT F** will be ignored after the filling time has ended.

Booster function option

OBST:

Booster function

Adjustment range: ON / OFF

Factory setting: OFF



This function is used for switching on a second pump when filling the solar system. When solar loading starts, R2 is energised in parallel to R1. After the filling time (**tFLL**) has ended, R2 is switched off.



Note:

The booster function is available in system layout 1 (Arr = 1) only.

The booster function will only be available if the drainback option has been activated.

Operating mode

MAN1 / MAN2:

Operating mode
Adjustment range:
OFF, Auto, ON
Factory setting: Auto



For control and service work, the operating mode of the controller can be manually adjusted. For this purpose, select the adjustment value **MAN1**, **MAN2** in which the following adjustments can be made:

• MAN1 / MAN2

Operating mode

OFF : relay off (flashing) +

Auto: relay in automatic operation

ON : relay on (flashing) + + /



Note:

Always adjust the operating mode back to “Auto” when the control and service work is completed. Normal operation is not possible in manual mode.

HE pump control

ADA1 / ADA2:

HE pump control
Adjustment range: ON/OFF
Factory setting: OFF



This option is used for controlling high-efficiency pumps via a VBus®/PWM adapter. The power supply of the pump(s) takes place via the semiconductor relay(s). For pump speed control with activated ADA1/ADA2 option, the relay is switched on or off (no pulse packets). Temperature dependent speed information is transmitted via the VBus®. The relay will remain deactivated for 1 hour after its switch-off conditions have been fulfilled (pump protection).



Note:

The parameter ADA1 refers to relay 1 and is available in all system layouts. The parameter ADA2 refers to relay 2 and is available in the system layouts 2, 6, 7, 8.

Language

LANG:

Language selection
Selection: dE, En, Fr
Factory setting: En



The menu language can be adjusted in this channel.

- dE : German
- En : English
- Fr : French

Unit

UNIT:

Temperature unit selection
Selection: °C, °F
Factory setting: °C



In this adjustment channel, the display unit for temperatures and temperature differences can be chosen. The unit can be switched between °C / K and °F / °Ra during operation. Temperatures and temperature differences in °F and °Ra are displayed without units. If the indication is set to °C, the units are displayed with the values.

Reset

RESE

Reset function



By using the reset function, all adjustments will be set back to the factory settings.

→ To initiate a reset, press button 3

Any previous adjustments will be lost. Therefore, initiating the reset function is always followed by a security enquiry.

Only confirm the security enquiry if you are sure that you wish to reset all adjustments to the factory settings!

→ To confirm the security enquiry, press button 3



Note:

Whenever a reset has been completed, the controller runs the commissioning menu again (see chap. 3).

Security enquiry:

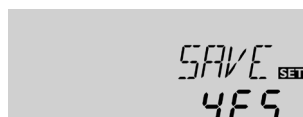

5. Troubleshooting

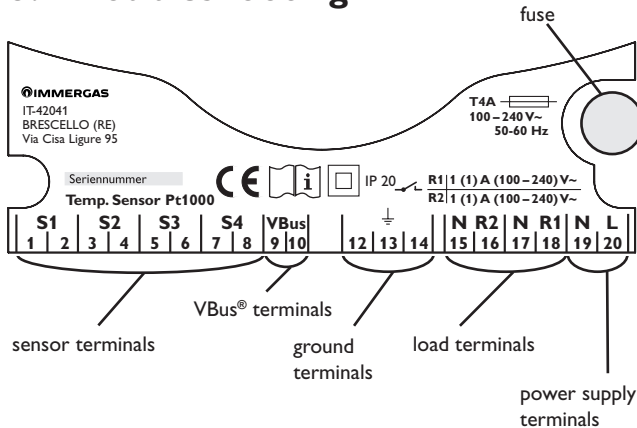

In the case of an error, a message is shown on the display of the controller:

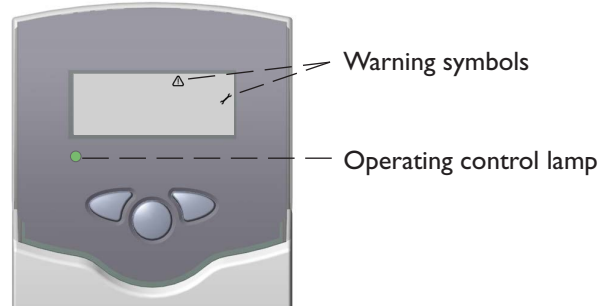

Operating control lamp flashes red. On the display the symbols and appear.

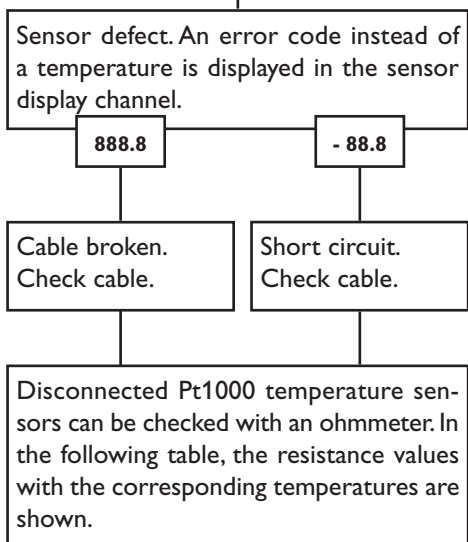

°C	°F	Ω	°C	°F	Ω
-10	14	961	55	131	1213
-5	23	980	60	140	1232
0	32	1000	65	149	1252
5	41	1019	70	158	1271
10	50	1039	75	167	1290
15	59	1058	80	176	1309
20	68	1078	85	185	1328
25	77	1097	90	194	1347
30	86	1117	95	203	1366
35	95	1136	100	212	1385
40	104	1155	105	221	1404
45	113	1175	110	230	1423
50	122	1194	115	239	1442

Resistance values of the Pt1000-sensors

Operating control lamp off.

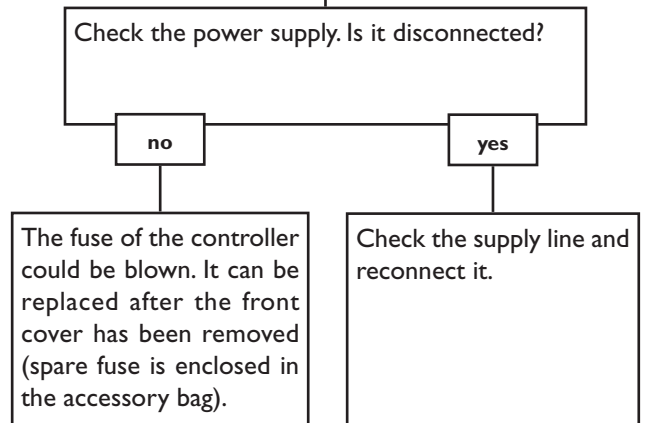

5.1 Various

Pump is overheated, but no heat transfer from the collector to the store, flow and return have the same temperature; perhaps also air / gas bubbles in the lines.

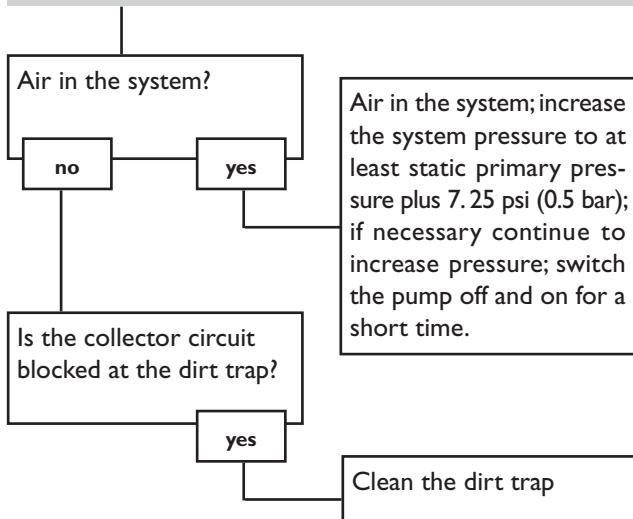

Pump starts for a short moment, switches off, switches on again, etc.

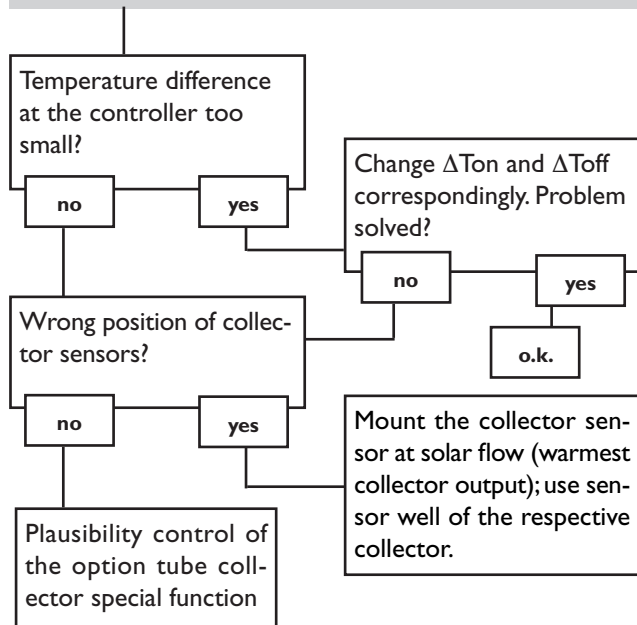

Pump starts up very late

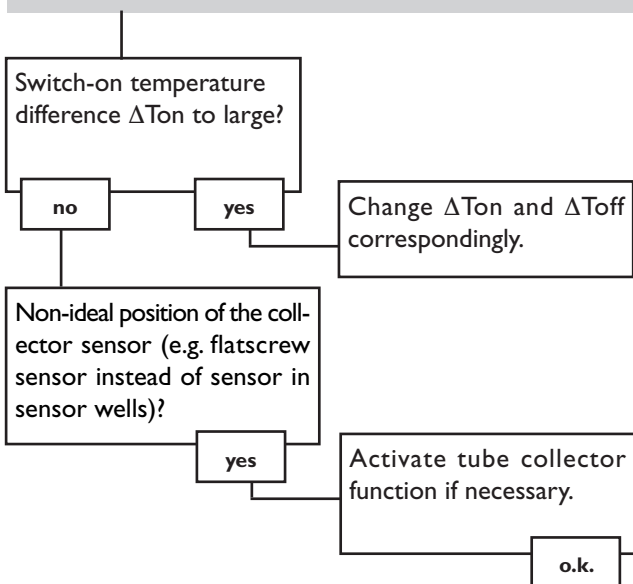

The temperature difference between store and collector increases enormously during operation; the collector circuit cannot dissipate the heat.

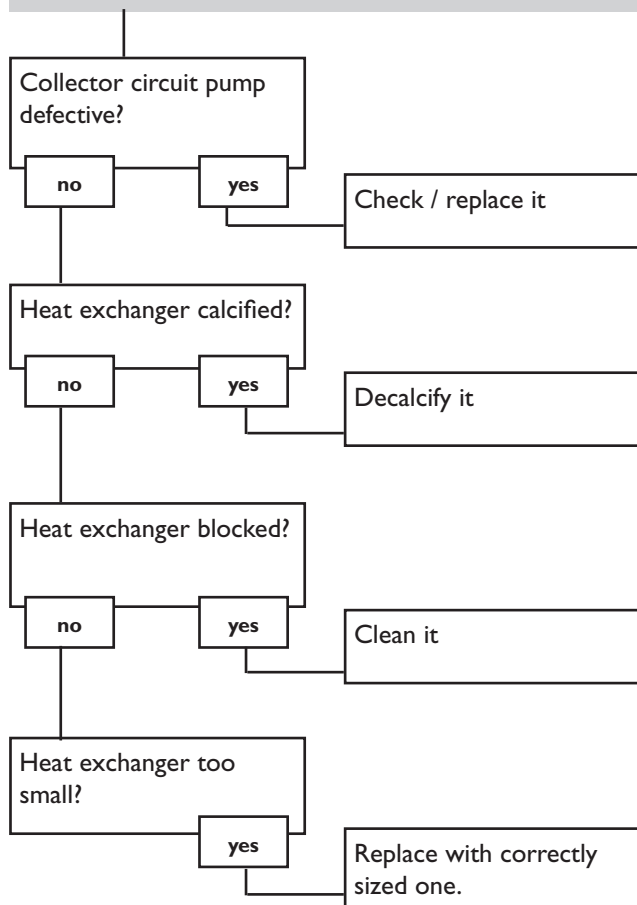

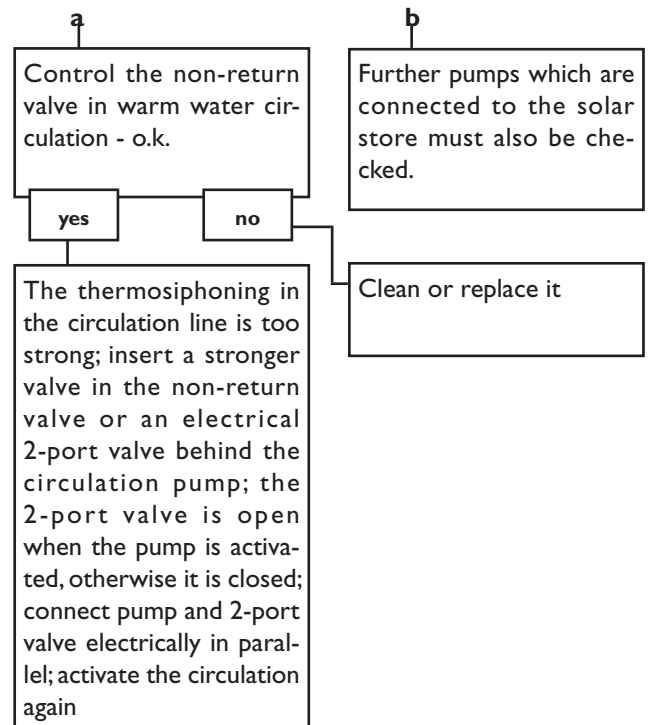
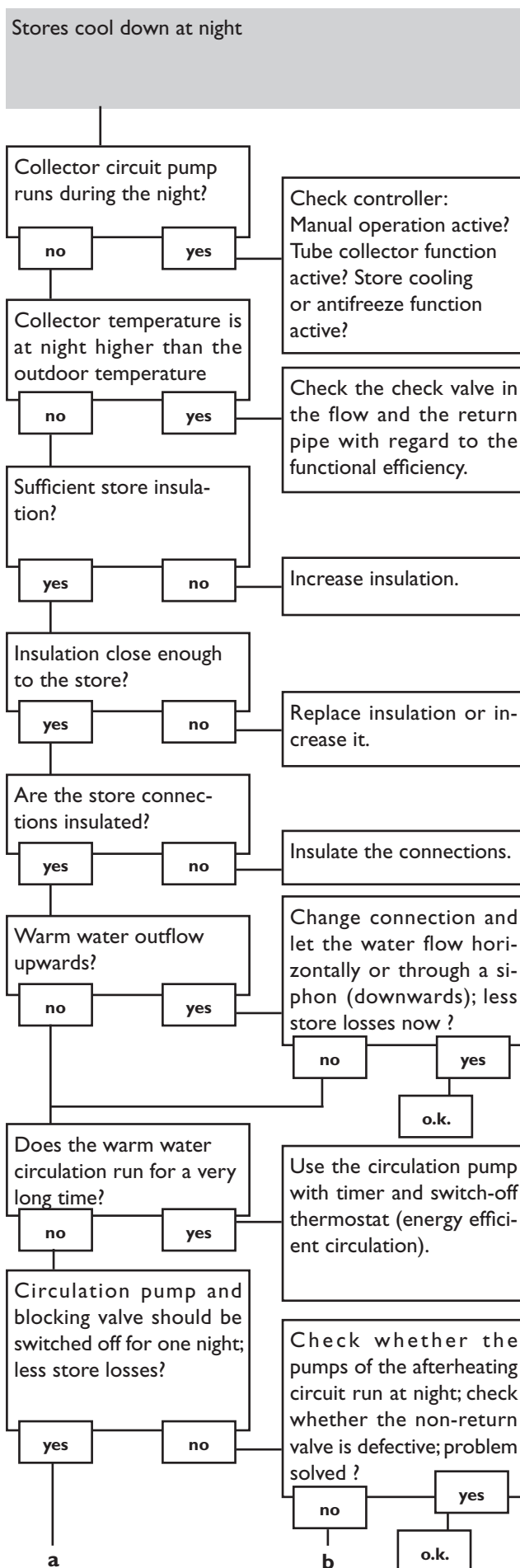

The solar circuit pump does not work, although the collector is considerably warmer than the store.

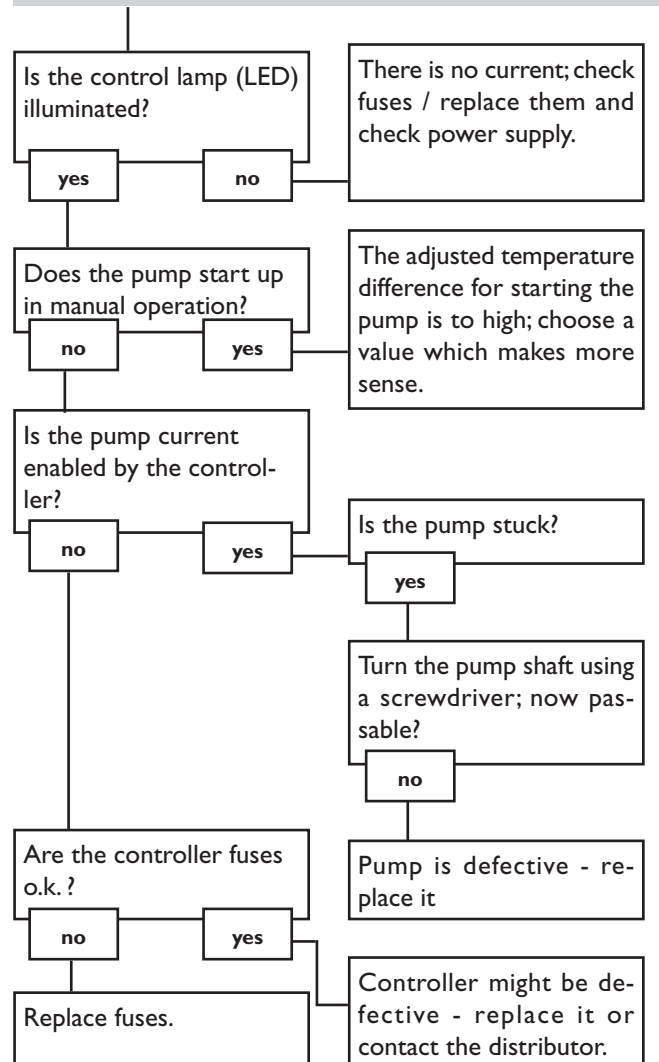

Distributed by:

IMMERGAS S.p.A.

VIA CISA LIGURE 95

42041 BRESCELLO (RE) ITALY

TEL. (+39) 0522/689011

FAX (+39) 0522/689102

WWW.IMMERGAS.COM

IMMERGAS@IMMERGAS.COM