

MANUAL
USER'S

 **IMMERGAS**

IE

**Instructions and
warnings**

Installer

User

Maintenance technician

System Manager Kit

Electronic control



Dear Customer,

*Congratulations for having chosen a top-quality **Immergas** product, able to assure well-being and safety for a long period of time.*

*As an **Immergas customer** you can also count on Qualified Post-Sales Service, prepared and updated to guarantee constant efficiency of your "System Manager Kit".*

*We would like to provide you with some important indications, your observance of which will ensure your satisfaction with the **Immergas** product:*

- Read the following pages carefully: you will find useful suggestions regarding the correct use of the device.
- For assistance and scheduled maintenance, contact "**Authorised After-Sales Centres**": they have original spare parts and are specifically trained.

Foreword.....	6	5.4.4 Setpoint Correction (P81 ÷ P84).....	22
General warnings	6	5.5 Temperature regulation (T01 ÷ T20).....	23
Cleaning the case.....	6	5.6 Domestic hot water.....	23
Warning.....	6	5.7 Solar system.....	24
1 Description control panel.....	7	5.8 Integration.....	25
1.1 Buttons description.....	7	5.9 Supervisor.....	26
1.2 Description of the display screen.....	8	5.10 Telephone dialler.....	26
1.3 Display - firmware revision.....	8	5.11 Reset counter.....	26
2 “System manager kit” user settings.....	9	5.12 Manual management.....	26
2.1 Start-up.....	9	5.13 Initialization.....	27
2.1.1 Main page.....	9	5.14 Cascade parameters.....	27
2.1.2 Programming current time and day.....	9	6 List of programmable parameters.....	28
2.2 Selection of operating mode.....	10	7 Notes for devices for zones.....	48
2.2.1 Functioning in STAND-BY mode.....	10	7.1 Notes for zone control.....	48
2.2.2 Operation in SUMMER mode.....	10	7.2 Notes for zone remote control.....	49
2.2.3 Operation in summer mode with cooling.....	10	7.3 Notes for the zone remote panel.....	53
2.2.4 Operation in winter mode.....	11	7.4 Notes for Dominus (Optional).....	53
2.2.5 Room antifreeze function.....	11	8 Generators Configuration.....	54
2.3 Domestic hot water temperature setting.....	11	8.1 Heat Pumps Configuration.....	54
2.4 Domestic hot water temperature setting on boiler side.....	12	8.1.1 Communication analysis.....	54
2.5 Setting comfort and reduced room temperature.....	12	8.1.2 Magis Pro V2 configuration.....	54
2.6 Programming operating time in comfort mode.....	13	8.1.3 Magis Combo V2 configuration.....	54
2.6.1 Daily hourly program.....	13	8.1.4 Magis M configuration.....	55
2.6.2 Weekly hourly program.....	13	8.1.5 Work range of heat pumps.....	55
2.6.3 Holiday program.....	14	8.2 Boiler Configuration.....	56
2.7 System Management.....	14	8.2.1 Connection via Immergas BMS.....	57
2.7.1 Floor Drying function.....	15	8.2.2 Connection via ModBus interface.....	57
2.8 Generators management.....	15	8.2.3 Connection via analogue 0-5 v signal.....	57
3 Information.....	17	8.2.4 Connection via analogue 0-10 V signal and DHW thermostat.....	57
3.1 ZONE menu.....	17	8.2.5 Connection via dry contact.....	57
3.2 DHW menu.....	17	9 Wiring diagrams.....	58
3.3 HEAT PUMP menu.....	17	9.1 System manager - power supply connection... ..	58
3.4 INTEGRATION GENERATOR menu.....	17	9.2 System manager - connection to Magis Pro V2 and Magis Combo V2.....	59
3.5 other functions menu.....	17	9.3 System Operator - Connection To Magis M.....	60
3.6 Hours of operation.....	17	9.4 System manager - Magis Pro V2 battery connection.....	61
4 Diagnostics and errors.....	18	9.5 System Operator - Magis M Battery Connection.....	62
4.1 Diagnostics.....	18	9.6 System manager - connection to common flow probe.....	63
4.2 Reset errors.....	18	9.7 System manager - connection to electric central heating integration resistance.....	64
5 Service menu.....	19	9.8 System manager - connection to electric DHW integration resistance.....	64
5.1 LANGUAGE Menu.....	19	9.9 System operator - connection to Victrix Superior 2022.....	65
5.2 INFORMATION Menu.....	19		
5.3 Functions protected by code.....	19		
5.4 System definition.....	20		
5.4.1 Zones (P01 - P23).....	20		
5.4.2 Heat pumps (P31).....	21		
5.4.3 Other functions (P61 - P69).....	21		

9.10	System manager - connection to Victrix Extra - Victrix Extra Plus - Victrix Maior - Victrix Maior Plus - Victrix Tera Vip V2.	66	9.34	System manager - connection to DHW recirculation.	83
9.11	System manager - connection to Victrix Pro V2.	67	9.35	System manager - connection to photovoltaic system.	84
9.12	System manager - connection to boiler via Modbus Rs-485 Electronic Board.	68	9.36	System manager - connection to dominus.	84
9.13	System manager - connection to Hercules Condensing Erp, Hercules Mini Condensing Erp and Ares Condensing 32 Erp boilers via external probe input.	69	9.37	System manager - connection to domotics with digital signals.	85
9.14	System manager - connection to Victrix Pro via 0-10 V input and sanitary thermostat.	70	9.38	System manager - connection to domotics with communication protocol.	86
9.15	System manager - connection to boiler through TA input.	71	9.39	System manager - connection to phone dialler.	86
9.16	System manager - connection to boiler alarm signal.	71	9.40	System manager - connection to thermoflue.	87
9.17	System manager - expansions power supply connection.	72	9.41	System manager - puffer probe connection.	88
9.18	System manager - expansion communication cable connection.	73	9.42	System manager - central heating/cooling three-way connection in systems with puffer.	88
9.19	System manager - TA request connection with 1 fixed zone.	74	9.43	System manager - three-way connection integration into systems with puffer.	89
9.20	System manager - storage tank three-way connection.	74	9.44	System manager - connection to inertial storage tank probe.	90
9.21	System manager - expansion zone pump connection.	75	9.45	System manager - connection to 1 sloping roof thermal solar system.	90
9.22	System manager - expansion zone flow probe connection.	75	9.46	System manager - connection to 2 sloping roofs thermal solar system.	91
9.23	System manager - expansion zone mixer connection.	76	9.47	System manager - solar return probe connection.	92
9.24	System manager - connection to zone room thermostats.	77	9.48	System manager - connection to external probe.	93
9.25	System manager - connection to safety thermostat.	78	9.49	System manager - connection to plate exchanger downstream of heat pump.	93
9.26	System manager - connection to humidistat.	78	10	List of anomalies.	94
9.27	System manager - connection to zone remote panels.	79	11	Product specifications.	95
9.28	System manager - connection to temperature and humidity probe.	79			
9.29	System manager - connection to zone remote controls.	80			
9.30	System manager - connection to dehumidifier kit.	81			
9.31	System manager - high-temperature zone valves connection.	82			
9.32	System manager - summer/winter three-way connection.	82			
9.33	System manager - thermal discharge connection.	83			

FOREWORD

The programmable “Immergas” “System Manager Kit” was designed to guarantee ideal temperature conditions at any time of day and night, for every single day of the week, using the most economically advantageous source of energy based on the characteristics of the installed components and environmental conditions.

The main control possibilities are:

1. Direct system without mixed valves and without dehumidifiers with integration either through resistances or boilers, and management of the solar system with a layer.
2. System for up to 8 zones, with 3-point mixer, and management of a high temperature zone with boiler integration.
3. As in the aforementioned cases but with the possibility of managing the solar part on two layers and a high temperature zone.
4. As in the aforementioned cases but with the possibility of managing a puffer for the solar integration of CH.

The customer can change the basic program according to their requirements.

Programming the “System Manager Kit” is extremely easy and a wide display screen allows you to constantly control all set values.

GENERAL WARNINGS

- Carefully read the warnings contained in this document as they are required to indicate how to use the “System Manager Kit” envisioned by the design, technical features, programming, adjustment and use.
- The system must be compliant with applicable IEC Standards.
- The instruction manual must be considered a part of the “System Manager Kit” and must be “**kept for future reference**”.
- The “System Manager Kit” is intended only for the use for which it has been expressly designed. Any other use must be considered improper and therefore dangerous.
- Our products are manufactured in compliance with the Safety Standards in force. It is, therefore, recommended to use all devices and attention in such a way that injury/damage is not caused to persons or objects.
- Do not remove parts of the “System Manager Kit” when it is operating.
- Do not use the “System Manager Kit” exposed to sources of heat or under the scorching sun.

- In case the manager is switched-off, it is necessary to also switch-off all devices connected to it (e.g. Heat pump, expansions etc.)
- The manufacturer will not be held responsible in the following cases:
 - a) Incorrect installation.
 - b) Malfunctions of the equipment to which the “System manager kit” is applied.
 - c) Unauthorised changes or tampering.
 - d) Total or partial failure to comply with instructions.
 - e) Exceptional events etc.

CLEANING THE CASE

To clean the case of “System Manager Kit” use damp cloths. Never use abrasive or powder detergents.

WARNING

Immergas reserves the right to make improvements and changes to details and accessories, excepting the essential features of the model described and illustrated herein.

1 DESCRIPTION CONTROL PANEL

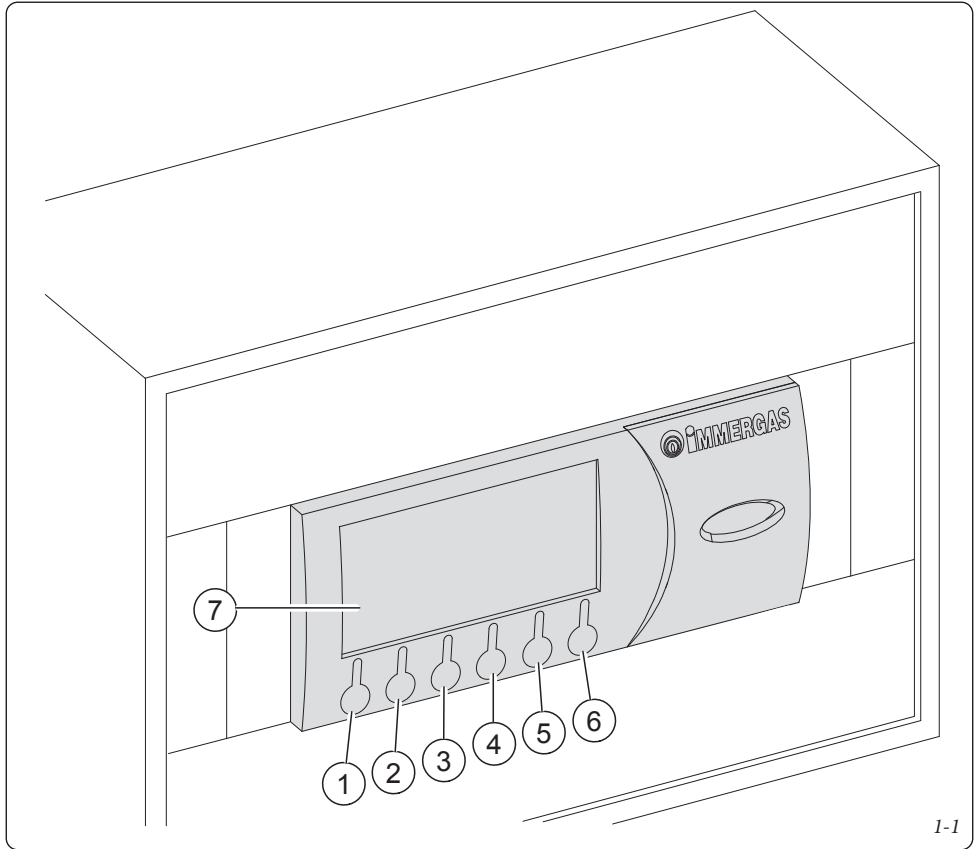

1-1

Key:

1. Button to change the operating mode summer/winter/stand-by (**MODE**).
2. Access button to submenus (**PRE**).
3. Button to move from a menu to the previous one (**ESC**).
4. Downwards menu/values scroll button, decreasing parameters button (**↓**).
5. Upwards menu/values scroll button, increasing parameters (**↑**).
6. Button of confirmation for parameter variation (**↵**).
7. Display.

N.B.: Some buttons can have different meanings and functions depending on the displayed context.

1.1 BUTTONS DESCRIPTION.

The button (*Ref. 1 Fig. 1-1*) allows you to change the operating mode of the system, specifically:

- Summer (only DHW management).
- Summer with cooling (summer air conditioning).
- Winter (winter air conditioning).
- Stand-by (no request satisfied with the exception of the environmental antifreeze protection and system deaeration).

The button (Ref. 2 Fig. 1-1) allows you to access the submenu:

- Selection menu for room comfort and reduced Set Point;
- Programming menu for clock and time periods (4 daily on-off time periods for the comfort temperature);
- "Info" menu, to view the "System Manager Kit" input data (ex. external temperature, flow temperature, set flow temperature, DHW temperature, solar storage tank probe temperature);
- Alarms records;
- Assistance menu.

The button (Ref. 3 Fig. 1-1) allows you to move back from a current menu to the previous one.



















The buttons (Ref. 4 and 5 Fig. 1-1) are used to cyclically scroll through the menus on the display. On the main screen they allow you to view:

- "Set DHW";
- "Set room and flow zone 1";
- "Set room and flow zone 2";
- "Set room and flow zone 3";
- "Set room and flow zone 4";
- "Set room and flow zone 5";
- "Set room and flow zone 6";
- "Set room and flow zone 7";
- "Set room and flow zone 8";
- "Set room and flow zone HT";

While the "DHW Set", "Room Set", "Flow Set" are displayed, press the button (Ref. 6 Fig. 1-1) to access and edit the displayed data; when the "Room Set" is changed the device will switch to manual operation until the controlled status change of the first time range in the "automatic" condition. When a variation is made to "Set DHW" or "Set flow" only the relative values will be changed; a variation made to "Set flow", if an external probe is being used, will be read by the supervisor as an offset compared to the value determined by the set curve. The set flow being sent to the heat pump and/or integration boiler will have a value of the maximum set value of $\pm 15^{\circ}\text{C}$.

If anomalies arise, from the heat pump, the current anomaly will appear on the screen and the possibility of verifying it in the alarms records menu. Within this menu it is possible to reset the alarms records or send the reset command to the machine (see Par. 4.2), it is possible to send a maximum of 3 consecutive restore commands; at the end of the three tries a new restore request will be provided after one hour.

1.2 DESCRIPTION OF THE DISPLAY SCREEN.

	Winter - dhw heating and room central heating functions are enabled;
	Summer - only the dhw heating function is enabled;
	Comfort temperature is active;
	Operating with energy savings programme (reduced);
	Operating with automatic program;
	Operating with manual program;
	Operating with holiday timer program;
	Symbol indicating anomaly;
	Room central heating request in progress;
	Request for dhw in progress;
	Summer with cooling - dhw heating and room cooling functions are enabled;
	Operating in "party" mode;
	Request to heat or cool room;
	Solar panel operation in progress;
	System in stand-by;
	Request for room cooling in progress;
	Dehumidifier with neutral air
	Dehumidifier with cooled air
	Post-circulation in progress

N.B.: some icons can assume different meanings according to the context, see the following paragraphs to identify the functions activated by the presence of several icons at the same time.

1.3 DISPLAY - FIRMWARE REVISION

The functions and menus described in this manual refer to firmware with revision 13.0.

2 “SYSTEM MANAGER KIT” USER SETTINGS

It is possible to set / modify the following parameters:

- DHW temperature;
- comfort and low temperature levels;
- daily / weekly hourly program operating / holiday timer program;
- assistance menu.

2.1 START-UP.

2.1.1 Main page

The main page (M01) shows the status of the main area. In particular, the following are visible:

- name of the area;
- room temperature;
- room humidity.

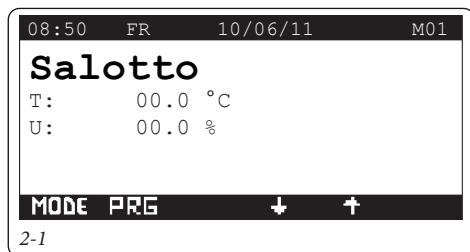

2.1.2 Programming current time and day

Press the **PRG** button to enter the navigation menu.

Press buttons **↓** **↑** until selecting menu “02. PROGRAMMING”.

Press button **←** to enter current “Time and Day” mode (K01).

Press the **←** button again to make the value indicating the hours to flash.

Set as desired by pressing arrows **↓** **↑**. At the end, press button **←** to confirm and for the minute figure to start blinking.

Proceed in the same way adjusting the minutes, day of the week, day, month and year.

At the end press button **ESC** twice to go back to the main screen.

2.2 SELECTION OF OPERATING MODE.



According to the functioning mode selected, the “System Manager Kit” performs the requests of the user, displaying the results on the display.

By pressing the **MODE** button, in sequence you pass the system operating modes:

- stand by;
- summer;
- summer with cooling;
- winter.

The antifreeze function is also present in the following modes: stand-by, summer and winter.

2.2.1 Functioning in STAND-BY mode

With the “System Manager Kit” in stand-by mode, the symbol  is displayed  (M01). The system can only work in case of room antifreeze request. In this status the current day and time are still displayed, along with any operating faults, present humidity percentage and ambient temperature in the main area.

N.B.: press arrows   to view the same parameters for any other stored areas.

2.2.2 Operation in SUMMER mode

Pressing button **MODE** switches to summer operation () the “System Manager Kit” enables the system to domestic hot water production only, disabling room central heating (M01). The display shows current day and time, any operating faults, ambient temperature and humidity percentage in the main area.



N.B.: press arrows   to view the same parameters for any other stored areas.

2.2.3 Operation in summer mode with cooling



Pressing button **MODE** switches to summer operation with cooling: the “System Manager Kit” enables both domestic hot water production and room cooling (M01). The display shows current day and time, any operating faults, ambient temperature and humidity percentage in the main area.

N.B.: press arrows   to view the same parameters for any other stored areas.

The “System Manager Kit” allows automatic functioning in cooling mode, in which a time program manages the room temperature during the hours of the day.

The desired room temperature can be adjusted onto two independent levels: comfort () and reduced (). The distribution of these levels throughout the day or week is controlled by the hourly programming (see *Parag. 2.5*).

The “System Manager Kit” is factory set as shown in the table below. If this should not satisfy requirements, it is possible to modify it as described in the following chapters.

Days	 28°C	 25°C
Mon-Fri	-	0 ÷ 24
Sat-Sun	-	0 ÷ 24



N.B.: the system is designed to function on comfort and reduced temperature levels depending on the hour program set. Therefore also during functioning in reduced room temperature conditions, if the temperature measured is above that set, the system can switch-on.

2.2.4 Operation in winter mode



Pressing button **MODE** switches to winter operation: the “System Manager Kit” enables both domestic hot water production and room central heating (**M01**). The display shows current day and time, any operating faults, ambient temperature and humidity percentage in the main area.

N.B.: press arrows   to view the same parameters for any other stored areas.

The “System Manager Kit” allows automatic functioning in central heating mode, in which a time program manages the room temperature during the hours of the day.

The desired room temperature can be adjusted onto two independent levels: comfort () and reduced (). The distribution of these levels throughout the day or week is controlled by the hourly programming (see *Parag. 2.5*).

The “System Manager Kit” is factory set as shown in the table below. If this should not satisfy requirements, it is possible to modify it as described in the following chapters.

Days	 16°C	 20°C
Mon-Fri	-	0 ÷ 24
Sat-Sun	-	0 ÷ 24

N.B.: the system is designed to function on comfort and reduced temperature levels depending on the hour program set. Therefore also during functioning in reduced temperature conditions, if the room temperature measured is below that set, the system can switch-on.

2.2.5 Room antifreeze function

Note: this function is only active in the winter, stand-by and summer mode.

The antifreeze function has maximum priority with respect to other settings. When ambient temperature drops below 5°C a central heating request at minimum setting is made. This situation remains active until there is a variation in room temperature of 1°C equal to 6°C measured in the area where the temperature below 5°C is detected.



2.3 DOMESTIC HOT WATER TEMPERATURE SETTING.

There are two modes for managing domestic hot water:

- Set DHW fixed;
- set DHW automatic.



In the first case it is sufficient to set a SET MANUAL to have a DHW setpoint that remains unchanged over time. If wanting to set two different setpoints, for example a daily one and a night one, it is necessary to enable time slots and set two different setpoints:



- set COMFORT;
- set ECO.

From the main screen (**M01**), press arrows   until the DHW set is displayed (**M02, M03**).

M02:

Press the  button again to make the first reading (DHW band enab.) blink.

Set as desired by pressing arrows  . At the end, press button  to confirm and for the next value (Manual Set) to start blinking. Proceed in the same way to set the next figures.



After setting the last figure, when button is pressed  the cursor no longer blinks and it is possible to change screens with buttons  .



At the end press button **ESC** twice to go back to the main screen.

- **Set manual:** it lets you set the DHW set-point valid until the next time range change (**M02**);
- **Temperature.:** it displays in real time the domestic hot water temperature (**M02**).
- **DHW band enab.:** enables only the Manual Set to be configured. If “Yes”, Set Comfort and Set Eco can also be configured (**M03**).

M03:

Press the  button again to make the first reading (Comfort Set) blink.

Set as desired by pressing arrows  . At the end, press button  to confirm and for the next figure (ECO Set) to start blinking. Proceed in the same way to set the next figures.



After setting the last figure, when button is pressed  the cursor no longer blinks and it is possible to change screens with buttons  .

At the end press button **ESC** twice to go back to the main screen.



- **COMFORT SET:** it lets you set the DHW set-point in the COMFORT time range (refer to settings of DHW time slots) (M03);
- **ECO Set:** it lets you set the DHW set-point in the ECO time range (refer to settings of DHW time slots) (M03);
- **Temperature:** it displays in real time the domestic hot water temperature (M03).



2.4 DOMESTIC HOT WATER TEMPERATURE SETTING ON BOILER SIDE.

If the system allows it (independent DHW circuit and boiler present), it is possible to set a specific boiler set-point, which is responsible for heating a portion or the entire storage tank at a specific temperature; this temperature is different from those set in the previous pages.

From the main screen (M01), press arrows   until the boiler side domestic hot water temperature figure is displayed (M04).

Press the  button again to make the first reading (boiler side water T.) blink.

Set as desired by pressing arrows  . At the end, press button  to confirm and for the next figure (DHW Set) to start blinking.



After setting the last figure, when button is pressed  the cursor no longer blinks and it is possible to change screens with buttons  .

At the end press button  twice to go back to the main screen.

2.5 SETTING COMFORT AND REDUCED ROOM TEMPERATURE.



It is possible to set two different room temperature levels:



- setpoint COMFORT;
- setpoint ECO.

Press the  button to enter the navigation menu. Press buttons   until selecting menu "01. SET-POINT".

Press button  to enter the first room set (Summer) (S02).

Press the  button again to make the first value (Comfort) to flash.

Set as desired by pressing arrows  . At the end, press button  to confirm and for the next figure (Low) to start blinking. Proceed in the same way for this setting then go to the last setting (Humidity).

When button  is pressed the cursor no longer blinks and it is possible to change screen with buttons   and set the figures of the next room sets (Summer with cooling, Winter) for each configured area.

Note: the new settings will be used at the next time range variation or temporarily setting the system to stand-by mode.

At the end press button  twice to go back to the main screen.

- **Party mode (S01).** Activating the party mode sets all zones in "Comfort" mode until the next programmed status change. The central heating or cooling mode will depend on the system state.



2.6 PROGRAMMING OPERATING TIME IN COMFORT MODE.

In this menu it is possible to:

- set 4 calendars for 4 different time slots;
- set a HOLIDAY program.

2.6.1 Daily hourly program



Press the  button to enter the navigation menu.

Press buttons   until selecting menu "02. PROGRAMMING".



- **Time programs.** It is possible to set 4 calendars containing 4 time slots for system operation in comfort mode. During the time outside these 4 time slots, the system will work in economy mode.

After setting these 4 calendars it is possible to associate them to the various days of the week and DHW function according to one's needs.

Press the  button to enter the menu.

Press buttons   to access screen "Comfort T. Ranges" (K02).

Press button  for the time of the first of the 4 time ranges to start blinking, with which it is possible to define the system's switch on and off time to maintain Comfort temperature.

Press arrows   to change the time. Press button  to confirm the change and move to the next time range.

Proceed in the same way to set the next time slots.



N.B.: the clips can be changed with a minimum time of 15 minutes.

In the event of not using all 4 time slots, set the unused ones with switch on and off time set to "00:00".



Proceed in the same way to program all days of the week. In the event programming should be repeated it may be copied from an already programmed day following the instructions in Paragraph 2.6.2 "Weekly hourly program".

2.6.2 Weekly hourly program

Press the  button to enter the navigation menu.

Press buttons   until selecting menu "02. PROGRAMMING".





Press the  button to enter the menu.

Scroll through screens with buttons   until accessing the menu "Program for zone 1." (K06).

Time slots (Calendars from 1 to 4) are assigned to Zones and DHW in these menus.

Therefore each day may be personalised with 4 different operating programs.

For convenient selection, the bottom part displays the graphics of the relevant calendar being selected (K06).

Press button  for the calendar to be assigned to Monday to start blinking. Press arrows   to set the desired calendar for zone 1 on Monday. Press button  to confirm and go to the next day.

Proceed in the same way to set calendars of individual days of the week for individual zones and /or DHW.

At the end press button  twice to go back to the main screen.

2.6.3 Holiday program

With this menu it is possible to temporarily disable system requests with the exception of:

- room antifreeze function;
- managing thermal solar system.

Press the **PRE** button to enter the navigation menu.

Press buttons **↓** **↑** until selecting menu "02. PROGRAMMING".

Press the **←** button to enter the menu.

Scroll through screens with buttons **↓** **↑** until accessing the menu "Time Ranges" (K16).

Press button **←** for the figure indicating the start date of the holiday to start blinking.

Press arrows **↓** **↑** to set day/month/year.

Proceed in the same way to set the end date of the holiday. The start and end date (restart will take place on the end date) will disable DHW and central heating/cooling operation; central heating is set at 5°C (all zones) to control ambient antifreeze. All operating modes for controlling the solar heating system will remain active, if activated in the configuration menu.

At the end press button **ESC** twice to go back to the main screen.

Holiday function activation is indicated by the icon  switching on in the main screen (M01).

2.7 SYSTEM MANAGEMENT

In this menu it is possible to:

- activation of SEPARATE HEATING / COOLING MANAGEMENT;
- activation of the FANCOIL IN WINTER function.

Press the button **PRE** to enter the navigation menu.

Press buttons **↓** **↑** until the "03. PLANT MANAGEMENT" menu is selected.

Press the button **←** to enter the menu.

- **Separate heating/cooling management (U01)**. The option enables a diverter valve to be activated for separation of hot/cold circuits. In the event of forced activation of the cooling request, the generator is activated at the set temperature.

Press the button **←** for the "Separate heat./cool. management" option to start blinking.

Set as desired by pressing arrows **↓** **↑**. Press the button **←** to validate the modification.

At the end press button **ESC** twice to go back to the main screen.

- **"Fancoil" in winter (U02)**. The option exclusively allows fan coils to be used in winter operation mode. This option may only be selected if it is provided for in the system definition. Fancoils operate at the temperature set on this page.

Press the button **←** for the "Fancoil in winter" option to start blinking.

Press arrows **↓** **↑** to confirm (YES) or cancel (NO) any option. Press the button **←** to validate the modification.

At the end press button **ESC** twice to go back to the main screen.

- **Deaeration (U03)**. It lets you alternatively enable system circulating pumps to aid in proper system venting.
- To activate the function, the system must be set in STAND-BY before entering the System Settings menu.
- The function deactivates automatically after 9 hours, changing the operational mode or manually disabling the function.

2.7.1 Floor Drying function.

A "Floor Drying" function can be enabled to perform thermal shock on new radiant panel systems, as required by the applicable standard.

Attention: contact the manufacturer of the radiant panels for the thermal shock characteristics and its correct execution.

N.B.: the system divided into zones must be properly connected both electrically and hydraulically.

The function lasts in total 7 days - 3 days at the lowest temperature set and 4 days at the highest temperature set.

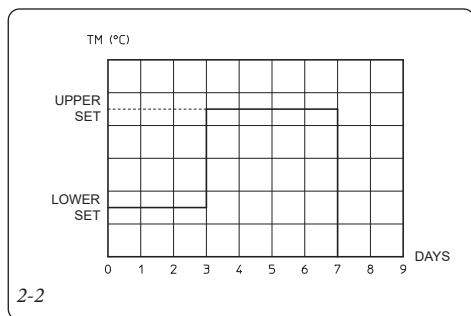

The standard function can be changed by modifying the value of the following parameters:

- **Set Min (U04).** Corresponds to the function use Lower Set.

- **Set Max (U04).** Corresponds to the function use Upper Set.

t1 (U04). Defines the time spent at minimum operating temperature during the active function.

K2 (U04). Defines the ascent gradient of the temperature.

t3 (U04). Defines the time spent at maximum operating temperature during the active function.

K4 (U04). Defines the descent gradient of the temperature.

Z1÷Z8 (U05). (Ne/Ano) Defines the zones active during the active function.

Active (U05): (Ne/Ano) The function is enabled.

N.B.: the screed heater function is visible and can only be enabled while the system is in STAND-BY.

Once the function is enabled, an alarm is shown on the display indicating the presence of the active function. This alarm signal does not correspond to an abnormal operation.

During active operation, it is possible to check in the INFO pages (I47):

- **Active Setpoint.** Temperature calculated during screed heater operation.

- **Remaining Days.** Days left until completion of the function.

In case of failure, the function is suspended and will resume when normal operating conditions are reset from the point where it was interrupted.

In the event of a power failure, the function is interrupted and then resumed when normal power supply conditions are restored.

Once the expected time expires, the system resumes normal functions in STAND-BY mode.

2.8 GENERATORS MANAGEMENT



In this menu it is possible to:

- set the energy prices in order to calculate the minimum COP;

- permanent or temporary disabling of heat pump operation;

- disabling of the integration generator (boiler or electrical resistance);

Press the  button to enter the navigation menu.

Press buttons   until selecting menu "04. GENERATORS MANAGEMENT".

Press the  button to enter the menu.

- **Gas prices (D01).** It lets you enter gas prices, also selecting GAS type (Nat. Gas/LPG). These data allow the system manager to calculate the working point with the maximum efficiency between heat pump operation and GAS boiler.

- **Electric Energy prices (D02).** It lets you enter electricity prices.

- **Time bands (D03).** Allows selecting between Dual-rate and Multi-rate tariff, enter the time slots related to the electricity prices.

- **Two-Part.** You can set the two daily time slots, the F1 and F2 tariffs are valid from Monday to Friday while the F2 tariff is applied to Saturday and Sunday.



- **Multi-Part.** You can set the three daily time slots, the F1, F2 and F3 tariffs are valid from Monday to Friday while the F2 tariff is applied to Saturday and Sunday.

- It is possible to associate a calendar with the heat pump power reduction function (D04).

- **Heat pump manual disable command (D05).** The option lets you permanently disable heat pumps as the main generator.

- **Heat pump temporary enable command (D05)**. The option lets you enable heat pumps according to the time slots that will be set in the next page (D06).

Press button  for the option “Disable heat pumps” to start blinking.

Press arrows   to confirm (YES) or cancel (NO) any option. Press the  button to validate the modification.

At the end press button  twice to go back to the main screen.

In case of heat pump temporary enable you can set the ignitions calendar (D06).

- **Integration manual disable command (D07)**. Enables the operation of the secondary generator to be permanently disabled.
- **Heat pump noise reduction (D08)**. In units where this function is present, it allows you to set the noise reduction mode.

3 INFORMATION

In the following pages it is possible to view the main system information, in particular parameters relating to:

- zone management;
- domestic hot water;
- heat pump management;
- integration generator management;
- other functions.

Press the **PRG** button to access the programming menu.

Press buttons **↓** **↑** until selecting menu "05. INFO".

Press the **←** button to enter the menu.

Within the menu, using the **↓** **↑** arrows, one can view the data of interest for the user.

3.1 ZONE MENU.

- **Heat pump probes temperature (I01)**
- **Temperature required for area systems (I02, I03 and I04).**

The presence of a request from a zone is highlighted with an asterisk.

The request for dehumidification of neutral air is highlighted with a D.

The request for dehumidification of cooled air is highlighted with an A.

- **Dew point (I05)**
- **Zone probe temperature (I07 - I14)**

In the event of active requests for dehumidification with neutral air or dehumidification with cooled air the relative icons will be displayed.

3.2 DHW MENU.

- **D.H.W. data (I51, I52 and I53)**

Info	I51
DHW	
Setpoint	: 40 °C
DHW Temp	: 45.0 °C
Request	: OFF
Antileg.	: OFF
PRG ESC ↓ ↑	
3-1	

3.3 HEAT PUMP MENU.

- **Heat pump data (I21 ÷ I24)**

3.4 INTEGRATION GENERATOR MENU.

- **Machine performance (I31)**
- **Integration data (I32)**

3.5 OTHER FUNCTIONS MENU.

- **Solar probes temperature (I41)**
- **Puffer temperature (I42)**
- **Additional functions probes temperature (I43)**
- **Tonnes of CO₂ saved by using the heat pump (I44)**
- **Sundry inputs (I45)**

3.6 HOURS OF OPERATION

It is possible to read the operating hours of the heat pump, the auxiliary central heating and the solar pump.

- **Heat pumps (O01 to O04)**
- **Boiler (O05)**
- **Electric heaters (O06)**
- **Solar/Puffer (O07)**

4 DIAGNOSTICS AND ERRORS



4.1 DIAGNOSTICS.

The “System Manager Kit” control continually controls the functioning status of the whole system and signals any anomalies, stating the corresponding error code on the display.

In the case of a fault that cannot be reset, contact a qualified technician (e.g. the After-Sales Technical Assistance Service).





The alarm code is displayed in the event of an error, with the symbol  and icon  above the relevant button.

Press the button  to display the “Alarms log”; this section displays occurred alarms, not yet reset, from the most recent to the oldest.

Press arrows   to scroll and display all extant alarms.

The anomalies displayed in the “System manager kit” are listed in the “Anomalies list” chapter.

If no alarm has been triggered, it is still possible to view the “Alarms log” by proceeding as follows:

- press the button ;
- scroll with buttons   the navigation menu and select “06. ALARM LOG”.
- Press the  button to enter the menu.



As well as the error codes referring to the functioning state of the system, the “System Manager Kit” also checks its own functioning state, indicating any malfunctions.

4.2 RESET ERRORS.

Press the button  to display the “Alarms log” or via the navigation menu.

Press and hold the RES button to display the screen where it will be possible to reset the alarms and heat pump log (H02).

Press button  for the option “Reset log” to start blinking.

Press arrows   to confirm (YES) or cancel (NO) any reset. At the end, press button  to confirm and for the option “Reset generator system block” to start blinking. Proceed in the same manner to reset any pump and boiler alarms.

At the end press button  twice to go back to the main screen.

5 SERVICE MENU

In these pages of the menu it is possible to:

- set device language;
- display further system INFO.

Press the **PRG** button to enter the navigation menu.

Press buttons **↓** **↑** until selecting menu "07. SERVICE".

Press the **←** button to enter the menu.

From this screen it is possible to access the submenu to manage and configure the work parameters for the peripherals installed in the system. Some of these submenus are protected by a code (which can be used exclusively by the Immergas technician) while others are also visible to the user.

5.1 LANGUAGE MENU.

- **Language.** It is possible to choose the language that will be used in the application (Italian or English)

Press the arrows **↓** **↑** and select "01. Language".

Press the **←** button to enter the submenu (L01).

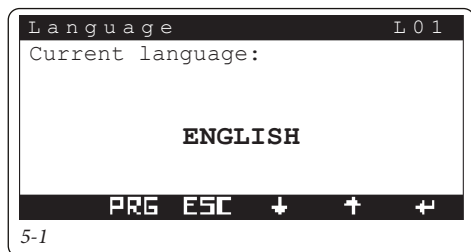

Press the **←** button again to make the language that requires changing to flash.

Press the arrows **↓** **↑** to select the desired language.

At the end, press the **ESC** button to go back to the "TECHNICIAN MENU".

5.2 INFORMATION MENU.

It is possible to view the firmware version of the device. There is also information relative to system operation and to the heat pump connected.

In particular, it is possible to view detailed information on:

- VERSION: firmware version and other system data.
- STATUS: parameters that identify the system operational mode.
- COMMUNICATION: status of devices connected on the network.
- HEAT PUMPS: detailed information on the heat pumps.
- INTEGRATION: detailed information on integration generators.
- INPUT/OUTPUT: system inputs and outputs.

Press the arrows **↓** **↑** and select "02. Information".

Press the **←** button to enter the submenu.

Press arrows **↓** **↑** to display the next screens of menu "02. Information".

- **Heat pump (N11).** The option lets you view detailed information on heat pumps.

At the end press button **ESC** twice to go back to the main screen.

At the end, press the **ESC** button to go back to the "TECHNICIAN MENU".

5.3 FUNCTIONS PROTECTED BY CODE

The sub-menus listed below, included in menu "07. SERVICE" are advanced settings (reserved to a qualified technician) and a password must be entered to access them.

- 03. System definition.
- 04. Thermoregulation.
- 05. DHW.
- 06. Solar system.
- 07. Integration.
- 08. Supervisor.
- 09. Reset Counter.
- 10. Manual.
- 11. Start Up.
- 12. Cascade parameters.

5.4 SYSTEM DEFINITION

Within this menu it is possible to set the features of the system that need to be managed.

Press the arrows   and select "05. System Definition".

Press the  button to enter the submenu. The sub-menus are:

- ZONES
- HEAT PUMPS
- SET CORRECTION
- OTHER FUNCTIONS



5.4.1 Zones (P01 - P23)

- **Zones Number.** The number of zones depends on the no. of expansion kits present.

N.B.: If the zone in high temperature is enabled, it will only be possible to select the gas boiler in the "Integration" menu.

N.B.: To enable the high temperature zone, all the other zones must be mixed.

Press the  button again until the parameter that requires changing starts to flash.

Press the arrows   to change the desired parameter. Press the  button again until the page title starts to flash.

By pressing the arrows   it is possible to view the other pages reported here below cyclically:

- **Zone 01.** Hot, cold, hot/cold.
- **COMM.** Absent, Rem. control, Remote panel, Zone control, Temp-humid probe
- **COMM type.** Fixed. Mixed.
- **Zone probe.** (Ne/Ano). In case of a fixed zone, it is possible to enable a zone probe to check the zone flow temp.

N.B.: When there is only one fixed zone it is not possible to use the temperature/humidity probes but only the zone control or ON/OFF inlet for this zone.

N.B.: For each zone it is possible to configure:

- **zone name** (max 10 characters);
- **possible presence of zone control** (Yes / No). If the zone control is disabled you will be requested to enable the room probe (temperature and humidity probe).

Using the screen (P21) it is possible to choose which zone will be displayed in the user's main menu.

If using dehumidifiers, it is necessary to set a maximum acceptable temperature for the dehumidifier (see relative instruction manual).

Furthermore, if the setpoint calculated for the dehumidification is too high to carry out a request, the alarm is signalled and the dehumidifier is stopped.

Dehum. Set Max (P22). Maximum temperature acceptable by the dehumidifier.

Alarm set (P22). Maximum calculated setpoint that the alarm is displayed for.

For systems with fancoils connected to expansion 5, it is possible to enable the system request even during the Winter phase. This is possible if the following condition is enabled FANCOIL IN WINTER = YES.

Request from fancoil zone (P23):

- YES = the heating request is carried out by expansion 5.
- NO = the heating request are carried out by zones 1+8.
- **Enabling room thermostat (Yes / No).** In the event of absence of zone device and zone probes, the room thermostat is automatically enabled.
- **Enabling humidostat (Yes / No).**
- **Enabling dew point calculation (intended to eliminate any formation of condensation) (Yes / No).** This option is not included in the high temperature zone.
- **Enabling dehumidifier (Yes / No).** This option is not included in the high temperature zone.

N.B.: all room thermostat inputs, if they are not being used to request heating or cooling, can be used to deactivate the zone of reference.

5.4.2 Heat pumps (P31)

The system allows you to choose the model of heat pump used (max. 4).

Machine power is automatically detected by the system.

N.B.: hook the heat pump up to the power supply only once all necessary settings have been made.

The following pages will be explored further in the chapter relative to heat pumps.

5.4.3 Other functions (P61 - P69)

The screen shown here below allows you to enable the presence of the solar circuit and the number of pumps included in this circuit.

N.B.: If the solar circuit is enabled it is also possible to enable the solar integration for central heating function (puffer).

- **Number of pumps.** (1 pump, 2 pumps, solar disabled); PUFFER management enables the heating of a technical water storage tank for heating and domestic hot water.
- **Presence (P62).** Enable/disable solar heating integration (Yes / No);
- **Pre-heating (P62).** Lets you enable Puffer pre-heating in a permanent manner (Yes / No);
- **Zone activation (P62):**
 - upon request: the zone pump activates upon receiving a request;
 - in temperature: the zone pump activates upon request only if the puffer reaches the set zone setpoint.
- **Hysteresis ON (P63).** The generator turns on for a setpoint lower than setpoint required + Hysteresis ON;
- **Hysteresis OFF (P63).** The generator turns on for a setpoint lower than setpoint required + Hysteresis OFF;
- **Gen.offset (P63).** Generator required setpoint correction value.
- **DHW OFF (P63):** Upon receiving a DHW request, the generator deactivates for a DHW temperature Exceeding: DHW setpoint + DHW OFF.

N.B.: if photovoltaic is active, pre-heating is automatically enabled with a fixed set equal to the maximum allowed by the heat pump.

- **Thermal discharge (P64).** One can decrease the temperature of the storage tank (usually a domestic hot water storage tank) when the temperature read by the probe on the storage tank exceeds the ΔT set (Delta temp.) compared to the value detected on the cold probe (pool or tank). The function is disabled when the two temperatures are equivalent.

- **Separate management of central heating and cooling (P65).** Allows to control a 3-way valve to choose whether to use the central heating system or the cooling one.
- **Enable generator switch off (P65).** It lets you switch off all generators via an external control (Yes / No). This function is useful if using a thermoflue.
Attention: if the generator switch-off signal is active, the cooling stage is also deactivated.
- **System decoupling (P66).** It allows the system to be controlled also through a plate exchanger downstream of the heat pump.
- **Photovoltaic (P66).** It supports heat pump use when photovoltaic panels are operating.
- **System probe (P66).** It allows managing the system through an additional generator flow probe.
- **Thermostat-controlled technical water storage tank (P67 to P69).** This function enables the management of a technical water storage tank that is temperature-controlled by means of a probe. The inertial storage tank can work as heating and cooling.
- **Presence (P67).** Activated/deactivates the thermostat controlled thermal storage tank (Ne/Ano).
- **Maintaining active (P67).** It makes it possible to maintain the inertial storage tank in temperature permanently (Ne/Ano).
- **Zone activation (P67):**
 - upon request: the zone pump activates upon receiving a request;
 - in temperature: the zone pump activates upon request only if the storage tank reaches the set zone setpoint.

CENTRAL HEATING (P68)

- **Hysteresis ON (P68).** The generator turns on for a setpoint lower than setpoint required + Hysteresis ON.
- **Hysteresis OFF (P68).** The generator turns on for a setpoint lower than setpoint required + Hysteresis OFF.
- **Gen.offset (P68).** Generator required setpoint correction value. Generator setpoint = request setpoint + gener. Offset.

COOLING (P69)

- **Hysteresis ON (P69).** The generator turns on for a setpoint higher than setpoint required + Hysteresis ON.
- **Hysteresis OFF (P69).** The generator turns on for a setpoint higher than setpoint required + Hysteresis OFF.
- **Gen.offset (P69).** Generator required setpoint correction value. Generator setpoint = request setpoint - gener. offset

N.B.: if photovoltaic is active and WINTER season, the storage tank is automatically heated at a fixed set equal to the maximum allowed by the heat pump.

If photovoltaic is active and SUMMER WITH COOLING season, the storage tank is automatically cooled at a fixed set equal to the minimum allowed by the heat pump.

5.4.4 Setpoint Correction (P81 ÷ P84)

In the case of hydraulic disconnections. The generator required setpoint can be corrected up to a maximum that can be set by the menu.

The correction is made until the temperature of the common flow probe is reached. Once the **activation time (P51)** has passed since the beginning of a requirement, the correction is activated and incremented by 1°C for every **increasing time (P81)**.

- **Max Heat.corr (P82).** Max correction during central heating mode.
- **Cool.Max corr (P82).** Max correction during cooling mode.

In the case of systems with zones, the generator required setpoint can be corrected up to a maximum that can be set by the menu.

The correction is made until the temperature of the zone flow probe is reached.

Once the **activation time (P83)** has passed since the beginning of a requirement, the correction is activated and incremented by 1°C for every **increasing time (P8)**.

- **Max. corr Heat (P84).** Max correction during central heating mode.
- **Max corr. Cool (P84).** Max correction during cooling mode.

- Enable external temperature probe presence.

- Not present
- From heat pump
- From boiler
- From the system manager

N.B.: If external probe use is enabled it is possible to construct the climatic curve (see example heating curve Fig. 5-2) for heating and cooling each individual zone.

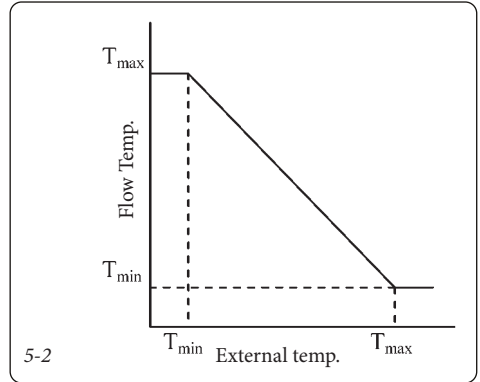

The flow temperature range of the zones are:

- Central heating: 20 ÷ 85
- Cooling: 4 ÷ 25

These values can be resized based on the type of generator present.

The work range in heating phase:

- Heat pump: 20 ÷ 60 (max)
- Electrical resistance: 20 ÷ 60 (max)
- Boiler: 20 ÷ 85
- Magis Combo: 20 ÷ 80
- Pdc absence: 20 ÷ 85
- Enable generator switch off = ON: 20 ÷ 85

The work range in cooling phase depend exclusively from the heat pump installed.

In reality the heat pump range value can be further reduced based on the type of heat pump (see Chapter related to the heat pump). However, in case of mixed zones, the following values remain fixed:

- minimum heating temperature = 20°C
- maximum cooling temperature = 25°C

5.5 TEMPERATURE REGULATION (T01 ÷ T20).

In this menu it will be possible to:

- activate operation with external probe;
- select the operating points for heating and cooling.

Press the arrows   and select "06. Temperature regulation".

Press the  button to enter the submenu. To build the climatic curve it is necessary to enter the required values in the screens shown here below.

Press the  button again until the parameter that requires changing starts to flash.

Press the arrows   to change the desired parameter.

Press the  button again until the page title starts to flash.

By pressing the arrows   it is possible to view the other pages cyclically:

- **External probe** (Yes / No) (T02).
- **Room sensor** (Yes / No) (T02).

It is possible to activate thermal adjustment for each individual zone.

- **Set Min.** (T02): setpoint corresponding to minimum outside temperature.
- **Set Max.** (T02): setpoint corresponding to maximum external temperature.
- **Min external** (T10). It lets you set minimum external temperature in the heating stage;
- **Max. external** (T10). It lets you set maximum external temperature in the heating phase.
- **Min external** (T19). It lets you set minimum external temperature in the cooling stage;
- **Max. external** (T19). It lets you set maximum external temperature in the cooling stage.
- **Set min. / Min. external** (T20). It lets you set minimum and minimum external temperature of the zone in high temperature;
- **Set max. / Max. external** (T20). It lets you set maximum and maximum external temperature of the zone in high temperature.

N.B.: if an anomaly is detected on the external probe, the system uses a fixed temperature value of 6°C.

5.6 DOMESTIC HOT WATER.

This menu will be enabled only if "Yes" has been set under "DHW" in the "System definition" menu.

Press the arrows   and select "Sanitario" (DHW).

Press the  button to enter the submenu (Q01).

- **Hysteresis** (Q01) (3÷12 °C default 5°C);
- **Offset** (Q01) (2÷30 °C default 10°C);

D.H.W. circuit (Q02). It is possible to set an independent or shared control for DHW management.

D.H.W. Simultaneous (Ne/Ano) Do not use.

Priority (only for independent DHW). In case of simultaneous system request (heat or cool) and DHW, the heat pump works based on precedence or on the DHW or the system.

Anti-legionella (Q03). Function that takes the DHW storage tank temperature to 65°C. Function possible only with boiler or electric resistance integration. If the recirculation pump is enabled, it will be activated as soon as the Anti-legionella Set is reached and will be deactivated once the maximum time is reached.

- **Enable** (Yes / No);
- **Day.** (the day of the week that the anti-legionella function is enabled);
- **Time.** (The time at which the anti-legionella function is enabled);

Reduced operation. One can temporarily vary the storage tank domestic hot water set-point (e.g. by setting it at 20 °C at night).

Recirculation pump (Q04). One can enable the operation of a recirculation pump on the domestic hot water system. There are 2 daily enabling slots available.

The timing (DHW and heating wait) must be determined according to the type of system and the amount of water.

- **Domestic hot water priority time.** It is the maximum time of operation in DHW in case of simultaneous request;
- **Central heating priority time.** It is the maximum time of operation in central heating in case of simultaneous request.



In case of simultaneous request (DHW and central heating) the system meets the DHW for the set time and switches to central heating for the set time until the requests are met.

5.7 SOLAR SYSTEM.

In this section it will be possible to set the values to manage the solar pump. This menu will be enabled only if “1” or “2” has been set under “Pump no.” in the “System definition” menu.

It is possible to install a second solar pump only if:

- there is only one heat pump;
- system decoupling disabled;
- system probe not installed.

Press the arrows   and select “08. Solar system”.

Press the  button to enter the submenu (W01).

- **ΔT activation (W01)** ($1 \div 20^{\circ}\text{K}$ default 6°K);
- **ΔT deactivation (W01)** ($0.5 \div 19.5^{\circ}\text{K}$ default 4°K);

The values reported above indicate the temperature difference between solar panel and storage tank. When this value is reached the solar circuit pump is either activated (started up) or deactivated (stopped).

N.B.: The screen for solar pump 2 is displayed even if only one solar pump has been configured.

- **Maximum T (W03).** Once this value has been exceeded the solar circuit pump stops working;
- **Enable (Yes / No) (W04).** The storage tank brings the maximum limit to 90°C and once the temperature of the manifold is lower than the one read on the storage tank, the pump is re-activated to cool the storage tank down until it reaches the maximum temperature;
- **Limit t. (W05)** Once this value has been exceeded the solar circuit pump stops working;
- **Enable: (Yes / No) (W06).** This forces the solar pump to exceed the set max T. even if the set max T. for the domestic hot water is reached (it avoids stagnating);
- **Max t. (W07)** The solar circuit pump starts working again to cool the solar collector when this value is exceeded. The pump switches off if the temperature of the manifold decreases or if the temperature of the storage tank reaches 90°C . In any case, the limit set in the “W05” screen.

N.B.: As soon as the temperature of the manifold falls below the set setpoint this function is disabled. The storage tank’s cooling system is also enabled when the temperature of the solar collector falls 5°C below that of the storage tank.

- **Enable (W07):** (Yes / No);
- **Min T. (W07):** ($10 \div 90^{\circ}\text{C}$) the solar circuit pump is enabled to start operating only if the temperature set on the manifold is reached.
- **Enable (Yes / No) (W08).** This allows the pump to be enabled to start heating the solar collector in case of very low temperatures.
- **Min.t. ($-10 \div 10^{\circ}\text{C}$) (W08).** The solar circuit pump is enabled to start working if the external temperature falls below this value.
- **Enable (Yes / No) (W09).** This allows the probe located on the solar circuit return to start working; The measured value will only be displayed.

5.8 INTEGRATION.

In this section it is possible to define auxiliary sources to be used to integrate the central heating or integration mode of action.

Press the arrows   and select "Integrazione" (Integration).

Press the  button to enter the submenu.

- **Type of integration (X01)**. (Gas boiler, electric resistance); type of boiler integration:

- room thermostat connection;
- external probe connection;
- connection with Modbus protocol;
- connection with Magis Combo;
- connection with Victrix Pro.

- **Alternative/Contemporary (X01)**. If the simultaneous functioning is selected the integration and the heat pump will work simultaneously, otherwise, if the alternative functioning is selected, either the integration will work or the heat pump will work, but never both at the same time. The simultaneous mode can be activated only if:

- integration with boiler connected with Modbus;
- integration with boiler through external probe.

- **DHW (X02)**. It is possible to select which generator takes care of the dhw mode:

- Heat Pump only;
- Boiler Only;
- Stand-alone boiler (instantaneous or with integrated boiler without heat pump preheating).
- Boiler and heat Pump.

- **Central heating (X02)**. It is possible to select which generator takes care of the heating mode:

- Heat Pump only;
- Boiler Only;
- Boiler and heat Pump.

- **Settings (X03)**. It allows setting:

- **DHW Time Delay**. It is the maximum wait time before activating the DHW integration;
- **Central heating Time Delay**. It is the maximum wait time before activating the central heating integration.

- **Integration limit (X04)**. If the flow temperature of the heat pumps is lower than the heating-set value minus the activation band divided by 2, then after a period equal to the activation delay time, the supplementary heater will be turned on.

Minimum integration temperature (X04). It lets you set the system's bivalent temperature;

- **Time waiting integration multiplier (X04)**. Allows you to change the integration operating time in case of activation due to failure to reach the set point.

The integration will work for a time equal to the DHW waiting time.

- **Offset (X05)**: (included only if the boiler is used as the source of integration); This is a flow temperature OFFSET value required by the boiler (0÷15 °C). This is not available in gas boilers with ON/OFF thermostat.

- **Boiler forced in DHW (X06)**. In the presence of common boiler and DHW, it is the boiler forcing DHW setpoint. Under this value only the boiler works.

5.9 SUPERVISOR.

In this section it is possible to set the type of supervision of the system management kit.

There are two types of supervision: digital and with communication protocol.

You can control the system through digital inputs on expansion 5. Contact the technical assistance for further information.

- **Enable (B01)**. The digital supervision function is enabled.

If this mode is activated you must insert the RS485 communication card in the appropriate housing called "serial card 1" (optional).

- **Protocol (B02)**. Set on Modbus / Carel / Winload

- **Band Rate (B02)**. 1200 / 2400 / 4800 / 9600 / 19200

- **Address (B02)**. Set Modbus address of manager. Contact the technical assistance for further information.

If this mode is activated you must insert the RS485 communication card in the appropriate housing called "serial card 2" (optional).

- **Protocol (B03)**. Set on Modbus / Carel / Winload

- **Band Rate (B03)**. 1200 / 2400 / 4800 / 9600 / 19200

- **Address (B03)**. Set Modbus address of manager. Contact the technical assistance for further information.

Dominus (Optional) (B04).

It is possible to control the system remotely, by using the optional Dominus kit (version 2.0 or later).

Connect to the appliance as shown (*Electrical Diagram Parag. 9.35*).

For further information consult the relative instruction sheet.

5.10 TELEPHONE DIALLER.

Using digital supervision, illustrated in the previous paragraph, it is possible to use a telephone dialler to manage system operational modes. For connections, see the related electrical diagram.

5.11 RESET COUNTER.

In this section it is possible to reset the operation hour counter for the heat pump, the source of integration, and solar circuit 1 and 2.

Press the arrows   and select "Reset Counter" (R01).

Press the  button to enter the submenu.

5.12 MANUAL MANAGEMENT.

In this section it is possible to, based on the selected configuration, enable or disable the various available controls.

Press the arrows   and select "Manual".

Press the  button to enter the submenu.

When you exit the menu any enabled commands are reset.

In the Cooling Test (A22) and Heating Test (A22) modes the Set Freq. corresponds to the maximum operating frequency of the machine.

In the Ramp Cooling Test and Ramp Heating Test modes, the Set Freq. corresponds to the slope of the frequency with which the machine is activated (Hz / min).

N.B.: in the Ramp Tests the Set Freq value can take negative values.

5.13 INITIALIZATION.

In this section it is possible to restore the factory settings. By performing this operation all of the operations previously carried out will be deleted including time periods, zone numbering, etc...

Press the arrows   and select "Initialization".

Press the  button to enter the submenu (Z01).

5.14 CASCADE PARAMETERS.

This menu is activated only if the heat pumps are more than one (max. 4). The manager deals with the activation and deactivation of the heat pumps according to the parameters set and to a possible request on the system. As a result of a heating request the heat pumps are activated in sequence, the activation of an individual heat pump is determined according to the flow temperature of the heat pumps in set configuration and to the heating-set. If the flow temperature of the heat pumps is lower than the heating-set value minus the activation band divided by 2, then after a period equal to the activation delay time, the next machine will be started and so on up to the maximum value set in the system definition parameter (P07).

Vice-versa if, after a deactivation delay time, the flow temperature of the heat pumps is higher than the heating-set value plus the activation band divided by 2, then one of the heat pumps will be switched off and so on up to complete switch-off of the heat pumps.

In the event of a domestic hot water or puffer request the operation is similar.

In the event of cooling requests the logic is inverted. (Activation if the flow temperature of the heat pumps is greater than the cooling-set plus activation band divided by 2).

N.B.: in order to simplify the installation and maintenance operations of the machines, it is necessary to separately power the heat pumps.

- Cascade Parameters (C01).

- **Simultaneous.** All machines in set configuration will intervene;
- **Cascade.** The machines are activated in sequence.

Attention: in case of installation in set configuration, each heat pump must be equipped with omnipolar disconnection.

- **Activation Band to Start or Stop HP (C02).** The cascade generators are activated/deactivated if the common delivery probe is outside the set-point range \pm temperature / 2 set (E.g. 45° flow 10 set-point, range = 40 ÷ 50 °C).

- **Heat/Cool mode (C03).** In case of heating or cooling mode it corresponds to the wait time before the activation or deactivation of a machine.

- **DHW mode (C04).** In case of DHW request it corresponds to the wait time before the activation of a machine.

N.B.: the total activation time (DHW and heating) of the machines in set configuration must be less than the integration time (if present).

- **Period used to Reverse (C05).** In presence of several heat pumps one can perform a rotation in the activation of the first heat pump in the cascade management. The parameter sets the for how many days the heat pump stays the first one to be activated.

6 LIST OF PROGRAMMABLE PARAMETERS.

“Main” menu.

No. page	Description	Range adjustment	Value default	Value customis.
M01	Working modes	Stand-by, Summer, Summer with Cooling, Winter	Stand-by	
M02	DHW Time bands enab.	No / Yes	No	
M02	DHW Manual set (permanent)	10 - 50 (60 with boiler/ electrical res.)	10	
M03	DHW Manual set (permanent)	30 - 60	30	
M04	DHW (Time bands disab.) Comfort set	10- 50 (60 with boiler/ electrical res.)	20	
M04	DHW (Time bands disab.) ECO set	10- 50 (60 with boiler/ electrical res.)	10	
M05	DHW (Boiler circuit)	10 - 60	20	
M06	ZN1 Set Room Temp	5,0 - 35,0 °C	20	
M06	ZN1 Set Flow Temp	5 - 85 °C °C	25	
M06	ZN1 Flow Offset	-15 - +15 °C	0	
M07	ZN2 Set Room Temp	5,0 - 35,0 °C	20	
M07	ZN2 Set Flow Temp	5 - 85 °C °C	25	
M07	ZN2 Flow Offset	-15 - +15 °C	0	
M08	ZN3 Set Room Temp	5,0 - 35,0 °C	20	
M08	ZN3 Set Flow Temp	5 - 85 °C °C	25	
M08	ZN3 Flow Offset	-15 - +15 °C	0	
M09	ZN4 Set Room Temp	5,0 - 35,0 °C	20	
M09	ZN4 Set Flow Temp	5 - 85 °C °C	25	
M09	ZN4 Flow Offset	-15 - +15 °C	0	
M10	ZN5 Set Room Temp	5,0 - 35,0 °C	20	
M10	ZN5 Set Flow Temp	5 - 85 °C °C	25	
M10	ZN5 Flow Offset	-15 - +15 °C	0	
M11	ZN6 Set Room Temp	5,0 - 35,0 °C	20	
M11	ZN6 Set Flow Temp	5 - 85 °C °C	25	
M11	ZN6 Flow Offset	-15 - +15 °C	0	
M12	ZN7 Set Room Temp	5,0 - 35,0 °C	20	
M12	ZN7 Set Flow Temp	5 - 85 °C °C	25	
M12	ZN7 Flow Offset	-15 - +15 °C	0	
M13	ZN8 Set Room Temp	5,0 - 35,0 °C	20	
M13	ZN8 Set Flow Temp	5 - 85 °C °C	25	
M13	ZN8 Flow Offset	-15 - +15 °C	0	
M14	ZHT Set Room Temp	5,0 - 35,0 °C	20	
M14	ZHT Set Flow Temp	5 - 85 °C °C	25	
M14	ZHT Flow Offset	-15 - +15 °C	0	

"Set point" menu.

No. page	Description	Range adjustment	Value default	Value customis.
S01	Party mode	No / Yes	No	
S02	Winter - Zone 1 Comfort Set	5 - 35	20	
S02	Winter ZN1 Economy Set	5 - 35	16	
S03	Winter - Zone 2 Comfort Set	5 - 35	20	
S03	Winter ZN2 Economy Set	5 - 35	16	
S04	Winter - Zone 3 Comfort Set	5 - 35	20	
S04	Winter ZN3 Economy Set	5 - 35	16	
S05	Winter - Zone 4 Comfort Set	5 - 35	20	
S05	Winter ZN4 Economy Set	5 - 35	16	
S06	Winter - Zone 5 Comfort Set	5 - 35	20	
S06	Winter ZN5 Economy Set	5 - 35	16	
S07	Winter - Zone 6 Comfort Set	5 - 35	20	
S07	Winter ZN6 Economy Set	5 - 35	16	
S08	Winter - Zone 7 Comfort Set	5 - 35	20	
S08	Winter ZN7 Economy Set	5 - 35	16	
S09	Winter - Zone 8 Comfort Set	5 - 35	20	
S09	Winter ZN8 Economy Set	5 - 35	16	
S10	Winter - HT Zone Comfort Set	5 - 35	20	
S10	Winter ZHT Economy Set	5 - 35	16	
S11	Summer with Cooling Z1 Comfort Set	5 - 35	25	
S11	Air Conditioning ZN1 Economy Set	5 - 35	28	
S11	Summer with Cooling Z1 Humidity Set	30% - 70%	50	
S12	Summer with Cooling Z2 Comfort Set	5 - 35	25	
S12	Air Conditioning ZN2 Economy Set	5 - 35	28	
S12	Summer with Cooling Z2 Humidity Set	30% - 70%	50	
S13	Summer with Cooling Z3 Comfort Set	5 - 35	25	
S13	Air Conditioning ZN3 Economy Set	5 - 35	28	
S13	Summer with Cooling Z3 Humidity Set	30% - 70%	50	
S14	Summer with Cooling Z4 Comfort Set	5 - 35	25	
S14	Air Conditioning ZN4 Economy Set	5 - 35	28	
S14	Summer with Cooling Z4 Humidity Set	30% - 70%	50	
S15	Summer with Cooling Z5 Comfort Set	5 - 35	25	
S15	Air Conditioning ZN5 Economy Set	5 - 35	28	
S15	Summer with Cooling Z5 Humidity Set	30% - 70%	50	
S16	Summer with Cooling Z6 Comfort Set	5 - 35	25	
S16	Air Conditioning ZN6 Economy Set	5 - 35	28	
S16	Summer with Cooling Z6 Humidity Set	30% - 70%	50	
S17	Summer with Cooling Z7 Comfort Set	5 - 35	25	
S17	Air Conditioning ZN7 Economy Set	5 - 35	28	
S17	Summer with Cooling Z7 Humidity Set	30% - 70%	50	
S18	Summer with Cooling Z8 Comfort Set	5 - 35	25	
S18	Air Conditioning ZN8 Economy Set	5 - 35	28	
S18	Summer with Cooling Z8 Humidity Set	30% - 70%	50	

“Programming” menu.

No. page	Description	Range adjustment	Value default	Value customis.
K01	Time	0 - 23	--	
K01	Minutes	0 - 59	--	
K01	Day of the week	Monday / Tuesday / Wednesday / Thursday / Friday / Saturday / Sunday	--	
K01	Day of year	1 - 31	--	
K01	Month of year	1 - 12	--	
K01	Year	0-99	--	
K02	Calendar 1 F1 ON	0-24, 0-45	00:00	
K02	Calendar 1 F1 OFF	0-24, 0-45	24:00	
K02	Calendar 1 F2 ON	0-24, 0-45	00:00	
K02	Calendar 1 F2 OFF	0-24, 0-45	00:00	
K02	Calendar 1 F3 ON	0-24, 0-45	00:00	
K02	Calendar 1 F3 OFF	0-24, 0-45	00:00	
K02	Calendar 1 F4 ON	0-24, 0-45	00:00	
K02	Calendar 1 F4 OFF	0-24, 0-45	00:00	
K03	Calendar 2 F1 ON	0-24, 0-45	6:00	
K03	Calendar 2 F1 OFF	0-24, 0-45	8:00	
K03	Calendar 2 F2 ON	0-24, 0-45	11:00	
K03	Calendar 2 F2 OFF	0-24, 0-45	13:00	
K03	Calendar 2 F3 ON	0-24, 0-45	17:00	
K03	Calendar 2 F3 OFF	0-24, 0-45	23:00	
K03	Calendar 2 F4 ON	0-24, 0-45	00:00	
K03	Calendar 2 F4 OFF	0-24, 0-45	00:00	
K04	Calendar 3 F1 ON	0-24, 0-45	7:00	
K04	Calendar 3 F1 OFF	0-24, 0-45	23:00	
K04	Calendar 3 F2 ON	0-24, 0-45	00:00	
K04	Calendar 3 F2 OFF	0-24, 0-45	00:00	
K04	Calendar 3 F3 ON	0-24, 0-45	00:00	
K04	Calendar 3 F3 OFF	0-24, 0-45	00:00	
K04	Calendar 3 F4 ON	0-24, 0-45	00:00	
K04	Calendar 3 F4 OFF	0-24, 0-45	00:00	
K05	Calendar 4 F1 ON	0-24, 0-45	00:00	
K05	Calendar 4 F1 OFF	0-24, 0-45	00:00	
K05	Calendar 4 F2 ON	0-24, 0-45	00:00	
K05	Calendar 4 F2 OFF	0-24, 0-45	00:00	
K05	Calendar 4 F3 ON	0-24, 0-45	00:00	
K05	Calendar 4 F3 OFF	0-24, 0-45	00:00	
K05	Calendar 4 F4 ON	0-24, 0-45	00:00	
K05	Calendar 4 F4 OFF	0-24, 0-45	00:00	
K06	Zone 1: Monday	CAL1, CAL2, CAL3,CAL4	CAL1	

No. page	Description	Range adjustment	Value default	Value customis.
K06	Zone 1: Tuesday	CAL1, CAL2, CAL3,CAL4	CAL1	
K06	Zone 1: Wednesday	CAL1, CAL2, CAL3,CAL4	CAL1	
K06	Zone 1: Thursday	CAL1, CAL2, CAL3,CAL4	CAL1	
K06	Zone 1: Friday	CAL1, CAL2, CAL3,CAL4	CAL1	
K06	Zone 1: Saturday	CAL1, CAL2, CAL3,CAL4	CAL1	
K06	Zone 1: Sunday	CAL1, CAL2, CAL3,CAL4	CAL1	
K07	Zone 2: Monday	CAL1, CAL2, CAL3,CAL4	CAL1	
K07	Zone 2: Tuesday	CAL1, CAL2, CAL3,CAL4	CAL1	
K07	Zone 2: Wednesday	CAL1, CAL2, CAL3,CAL4	CAL1	
K07	Zone 2: Thursday	CAL1, CAL2, CAL3,CAL4	CAL1	
K07	Zone 2: Friday	CAL1, CAL2, CAL3,CAL4	CAL1	
K07	Zone 2: Saturday	CAL1, CAL2, CAL3,CAL4	CAL1	
K07	Zone 2: Sunday	CAL1, CAL2, CAL3,CAL4	CAL1	
K08	Zone 3: Monday	CAL1, CAL2, CAL3,CAL4	CAL1	
K08	Zone 3: Tuesday	CAL1, CAL2, CAL3,CAL4	CAL1	
K08	Zone 3: Wednesday	CAL1, CAL2, CAL3,CAL4	CAL1	
K08	Zone 3: Thursday	CAL1, CAL2, CAL3,CAL4	CAL1	
K08	Zone 3: Friday	CAL1, CAL2, CAL3,CAL4	CAL1	
K08	Zone 3: Saturday	CAL1, CAL2, CAL3,CAL4	CAL1	
K08	Zone 3: Sunday	CAL1, CAL2, CAL3,CAL4	CAL1	
K09	Zone 4: Monday	CAL1, CAL2, CAL3,CAL4	CAL1	
K09	Zone 4: Tuesday	CAL1, CAL2, CAL3,CAL4	CAL1	
K09	Zone 4: Wednesday	CAL1, CAL2, CAL3,CAL4	CAL1	
K09	Zone 4: Thursday	CAL1, CAL2, CAL3,CAL4	CAL1	

No. page	Description	Range adjustment	Value default	Value customis.
K09	Zone 4: Friday	CAL1, CAL2, CAL3,CAL4	CAL1	
K09	Zone 4: Saturday	CAL1, CAL2, CAL3,CAL4	CAL1	
K09	Zone 4: Sunday	CAL1, CAL2, CAL3,CAL4	CAL1	
K10	Zone 5: Monday	CAL1, CAL2, CAL3,CAL4	CAL1	
K10	Zone 5: Tuesday	CAL1, CAL2, CAL3,CAL4	CAL1	
K10	Zone 5: Wednesday	CAL1, CAL2, CAL3,CAL4	CAL1	
K10	Zone 5: Thursday	CAL1, CAL2, CAL3,CAL4	CAL1	
K10	Zone 5: Friday	CAL1, CAL2, CAL3,CAL4	CAL1	
K10	Zone 5: Saturday	CAL1, CAL2, CAL3,CAL4	CAL1	
K10	Zone 5: Sunday	CAL1, CAL2, CAL3,CAL4	CAL1	
K11	Zone 6: Monday	CAL1, CAL2, CAL3,CAL4	CAL1	
K11	Zone 6: Tuesday	CAL1, CAL2, CAL3,CAL4	CAL1	
K11	Zone 6: Wednesday	CAL1, CAL2, CAL3,CAL4	CAL1	
K11	Zone 6: Thursday	CAL1, CAL2, CAL3,CAL4	CAL1	
K11	Zone 6: Friday	CAL1, CAL2, CAL3,CAL4	CAL1	
K11	Zone 6: Saturday	CAL1, CAL2, CAL3,CAL4	CAL1	
K11	Zone 6: Sunday	CAL1, CAL2, CAL3,CAL4	CAL1	
K12	Zone 7: Monday	CAL1, CAL2, CAL3,CAL4	CAL1	
K12	Zone 7: Tuesday	CAL1, CAL2, CAL3,CAL4	CAL1	
K12	Zone 7: Wednesday	CAL1, CAL2, CAL3,CAL4	CAL1	
K12	Zone 7: Thursday	CAL1, CAL2, CAL3,CAL4	CAL1	
K12	Zone 7: Friday	CAL1, CAL2, CAL3,CAL4	CAL1	
K12	Zone 7: Saturday	CAL1, CAL2, CAL3,CAL4	CAL1	

No. page	Description	Range adjustment	Value default	Value customis.
K12	Zone 7: Sunday	CAL1, CAL2, CAL3,CAL4	CAL1	
K13	Zone 8: Monday	CAL1, CAL2, CAL3,CAL4	CAL1	
K13	Zone 8: Tuesday	CAL1, CAL2, CAL3,CAL4	CAL1	
K13	Zone 8: Wednesday	CAL1, CAL2, CAL3,CAL4	CAL1	
K13	Zone 8: Thursday	CAL1, CAL2, CAL3,CAL4	CAL1	
K13	Zone 8: Friday	CAL1, CAL2, CAL3,CAL4	CAL1	
K13	Zone 8: Saturday	CAL1, CAL2, CAL3,CAL4	CAL1	
K13	Zone 8: Sunday	CAL1, CAL2, CAL3,CAL4	CAL1	
K14	HT Zone: Monday	CAL1, CAL2, CAL3,CAL4	CAL1	
K14	HT Zone: Tuesday	CAL1, CAL2, CAL3,CAL4	CAL1	
K14	HT Zone: Wednesday	CAL1, CAL2, CAL3,CAL4	CAL1	
K14	HT Zone: Thursday	CAL1, CAL2, CAL3,CAL4	CAL1	
K14	HT Zone: Friday	CAL1, CAL2, CAL3,CAL4	CAL1	
K14	HT Zone: Saturday	CAL1, CAL2, CAL3,CAL4	CAL1	
K14	HT Zone: Sunday	CAL1, CAL2, CAL3,CAL4	CAL1	
K15	DHW: Monday	CAL1, CAL2, CAL3,CAL4	CAL1	
K15	DHW: Tuesday	CAL1, CAL2, CAL3,CAL4	CAL1	
K15	DHW- Wednesday	CAL1, CAL2, CAL3,CAL4	CAL1	
K15	DHW - Thursday	CAL1, CAL2, CAL3,CAL4	CAL1	
K15	DHW - Friday	CAL1, CAL2, CAL3,CAL4	CAL1	
K15	DHW - Saturday	CAL1, CAL2, CAL3,CAL4	CAL1	
K15	DHW - Sunday	CAL1, CAL2, CAL3,CAL4	CAL1	
K16	Holiday start day	1 - 31	1	
K16	Holiday start month	1 - 12	8	
K16	Holiday start year	0-99	16	

No. page	Description	Range adjustment	Value default	Value customis.
K16	Holiday end day	1 - 31	31	
K16	Holiday end month	1 - 12	8	
K16	Holiday end year	0-99	16	
K16	Enable holiday	Yes/No	No	

“System Management” menu.

No. page	Description	Range adjustment	Value default	Value customis.
U01	Set cooling (separate heating / cooling management)	5-25	20	
U02	Enable use of fancoil in WINTER	Yes/No	No	
U02	Set zone flow	20-85	25	
U03	Venting	OFF/ON		
U04	Minimum Setpoint	20 - 45	25	
U04	Max Setpoint	25 - 55	45	
U04	T1 (start t.)	0 - 7	3	
U04	K2 (gradient from min to max)	1 - 30	30	
U04	T3 (maintaining t.)	0 - 14	4	
U04	K4 (gradient from max to min)	1 - 30	30	
U05	Z1	NO/YES	YES	
U05	Z2	NO/YES	YES	
U05	Z3	NO/YES	YES	
U05	Z4	NO/YES	YES	
U05	Z5	NO/YES	YES	
U05	Z6	NO/YES	YES	
U05	Z7	NO/YES	YES	
U05	Z8	NO/YES	YES	
U05	Enable screed heater function	NO/YES	NO	

“Generators Management” menu.

No. page	Description	Range adjustment	Value default	Value customis.
D01	Gas type	Nat. Gas / LPG	Nat. Gas	
D01	Nat. Gas	1 - 900,00 c€	100,00	
D01	Nat. Gas	1 - 900,00 c€	70,00	
D01	Unit of measurement LPG gas	m ³ / l / kg	litro	
D02	Elet. F1	1 - 900,00 c€	28,00	
D02	Elet. F2	1 - 900,00 c€	27,00	
D02	Elet. F3	1 - 900,00 c€	27,00	
D03	Tariff: Two part	Dual-rate, Multi-rate	Dual-rate	
D03	Slot 1 - ON	00:00 - 24:00	08:00	
D03	Slot 2 - ON	00:00 - 24:00	19:00	
D03	Slot 3 - ON	00:00 - 24:00	23:00	

No. page	Description	Range adjustment	Value default	Value customis.
D04	Heat Pump Power Reduction: Monday	CAL1, CAL2, CAL3,CAL4	CAL1	
D04	Heat Pump Power Reduction: Tuesday	CAL1, CAL2, CAL3, CAL4	CAL1	
D04	Heat Pump Power Reduction: Wednesday	CAL1, CAL2, CAL3, CAL4	CAL1	
D04	T Heat Pump Power Reduction: hursday	CAL1, CAL2, CAL3, CAL4	CAL1	
D04	Heat Pump Power Reduction: Friday	CAL1, CAL2, CAL3, CAL4	CAL1	
D04	Heat Pump Power Reduction: Saturday	CAL1, CAL2, CAL3, CAL4	CAL1	
D04	Heat Pump Power Reduction: Sunday	CAL1, CAL2, CAL3, CAL4	CAL1	
D05	Heat pump manual disable command	Yes/No	No	
D05	Heat pump tempor. enable command	Yes/No	No	
D06	Heat Pump Enable: Monday	CAL1, CAL2, CAL3,CAL4	CAL1	
D06	Heat Pump Enable: Tuesday	CAL1, CAL2, CAL3, CAL4	CAL1	
D06	Heat Pump Enable: Wednesday	CAL1, CAL2, CAL3, CAL4	CAL1	
D06	Heat Pump Enable: Thursday	CAL1, CAL2, CAL3, CAL4	CAL1	
D06	Heat Pump Enable: Friday	CAL1, CAL2, CAL3, CAL4	CAL1	
D06	Heat Pump Enable: Saturday	CAL1, CAL2, CAL3, CAL4	CAL1	
D06	Heat Pump Enable: Sunday	CAL1, CAL2, CAL3, CAL4	CAL1	
D07	Integration manual disable command	Yes/No	No	
D08	HP noise reduction	Yes/No	No	
D08	Noise reduction level	1 / 2	1	

Assistance \ Language” menu.

No. page	Description	Range adjustment	Value default	Value customis.
L01	Language	Italian / English Czech / Slovak / Hungarian / Turkish / Polish / Bulgarian	Italian	

“Service \ System definition” menu.

No. page	Description	Range adjustment	Value default	Value customis.
P01	Plant type	1 - 8	1	
P01	Zones number	No / Yes	Yes	
P01	DHW Enable	No / Yes	No	
P02	Mode	Hot, Cold, Hot/Cold	Hot	
P02	Comm.	NO, Rem. Control, Remote panel, Zone Control, Temp-humid probe	Remote panel	
P02	Thermostat	No / Yes	No	
P02	Type	Fixed / Mixed	Fixed	
P02	Zone probe	No / Yes	No	
P03	Humidostat	No / Yes	No	
P03	Dew Point	No / Yes	No	
P03	En. Dehum.	No / Yes	No	
P04	Mode	Hot, Cold, Hot/Cold	Hot	
P04	Comm.	NO, Rem. Control, Remote panel, Zone Control, Temp-humid probe	No	
P04	Thermostat	No / Yes	No	
P04	Type	Fixed / Mixed	Mixed	
P04	Zone probe	No / Yes	No	
P05	Humidostat	No / Yes	No	
P05	Dew Point	No / Yes	No	
P05	En. Dehum.	No / Yes	No	
P06	Mode	Hot, Cold, Hot/Cold	Hot	
P06	Comm.	NO, Rem. Control, Remote panel, Zone Control, Temp-humid probe	No	
P06	Thermostat	No / Yes	No	
P06	Type	Fixed / Mixed	Mixed	
P06	Zone probe	No / Yes	No	
P07	Humidostat	No / Yes	No	
P07	Dew Point	No / Yes	No	
P07	En. Dehum.	No / Yes	No	
P08	Mode	Hot, Cold, Hot/Cold	Hot	
P08	Comm.	No, temp-hum. probe	No	
P08	Thermostat	No / Yes	No	
P08	Type	Fixed / Mixed	Mixed	
P08	Zone probe	No / Yes	No	
P09	Humidostat	No / Yes	No	
P09	Dew Point	No / Yes	No	
P09	En. Dehum.	No / Yes	No	

No. page	Description	Range adjustment	Value default	Value customis.
P10	Mode	Hot, Cold, Hot/Cold	Hot	
P10	Comm.	No, temp-hum. probe	No	
P10	Thermostat	No / Yes	No	
P10	Type	Fixed / Mixed	Mixed	
P10	Zone probe	No / Yes	No	
P11	Humidostat	No / Yes	No	
P11	Dew Point	No / Yes	No	
P11	En. Dehum.	No / Yes	No	
P12	Mode	Hot, Cold, Hot/Cold	Hot	
P12	Comm.	No, temp-hum. probe	No	
P12	Thermostat	No / Yes	No	
P12	Type	Fixed / Mixed	Mixed	
P12	Zone probe	No / Yes	No	
P13	Humidostat	No / Yes	No	
P13	Dew Point	No / Yes	No	
P13	En. Dehum.	No / Yes	No	
P14	Mode	Hot, Cold, Hot/Cold	Hot	
P14	Comm.	No, temp-hum. probe	No	
P14	Thermostat	No / Yes	No	
P14	Type	Fixed / Mixed	Mixed	
P14	Zone probe	No / Yes	No	
P15	Humidostat	No / Yes	No	
P15	Dew Point	No / Yes	No	
P15	En. Dehum.	No / Yes	No	
P16	Mode	Hot, Cold, Hot/Cold	Hot	
P16	Comm.	No, temp-hum. probe	No	
P16	Thermostat	No / Yes	No	
P16	Type	Fixed / Mixed	Mixed	
P16	Zone probe	No / Yes	No	
P17	Humidostat	No / Yes	No	
P17	Dew Point	No / Yes	No	
P17	En. Dehum.	No / Yes	No	
P18	Comm.	NO, Rem. Control, Remote panel, Zone Control, Temp-humid probe	No	
P18	Thermostat	No / Yes	No	
P19	Names Zone 1,2,3,4,HT	1= Zona 1 2 = Zona 2 3 = Zona 3 4 = Zona 4 HT = Zona HT		

No. page	Description	Range adjustment	Value default	Value customis.
P20	Names Zone 5,6,7,8	5 = Zona 5 6 = Zona 6 7 = Zona 7 8 = Zona 8		
P21	Main zone	1 - 8	1	
P22	Dehum. Set Max	15 - 50	25	
P22	Alarm set	15 - 50	25	
P23	Request from fancoil zone	OFF/ON	OFF	
P31	Heat pumps	1 - 4	0	
P31	1:	Magis M, Magis Pro/ Combo V2, Audax, Audax Top, Audax kW, Magis Pro (V1), Magis Combo (V1), Magis Combo Plus (V1)	Magis M	
P31	2:	Magis M, Magis Pro/ Combo V2, Audax, Audax Top, Audax kW, Magis Pro (V1)	Magis M	
P31	3:		Magis M	
P31	4:		Magis M	
P32	Magis Pro Configuration	Two tubes / Four tubes	Two tubes	
P32	Magis Combo Configuration	Type A / Type B	Type A	
P33	Pump Logic	Max sp / Modul	Modul	
P33	Minim. Speed	19-50 %	50 %	
P33	Max. Speed	50-100 %	100 %	
P33	Delta T	2-20	5	
P34	Circulator anti-block	Yes/No	Yes	
P34	Flow switch	0-1	0	
P34	Reduction enable	NO/YES	No	
P34	Power	50-100 %	75 %	
P35	Pump Logic	Max sp / Modul	Modul	
P35	Minim. Speed	19-50 %	50 %	
P35	Max. Speed	50-100 %	100 %	
P35	Delta T	2-20	5	
P36	Circulator anti-block	Yes/No	Yes	
P36	Flow switch	0-1	0	
P36	Reduction enable	NO/YES	No	
P36	Power	50-100 %	75 %	
P37	Pump Logic	Max sp / Modul	Modul	
P37	Minim. Speed	19-50 %	50 %	
P37	Max. Speed	50-100 %	100 %	
P37	Delta T	2-20	5	
P38	Circulator anti-block	Yes/No	Yes	
P38	Flow switch	0-1	0	
P38	Reduction enable	NO/YES	No	
P38	Power	50-100 %	75 %	

No. page	Description	Range adjustment	Value default	Value customis.
P39	Pump Logic	Max sp / Modul	Modul	
P39	Minim. Speed	19-50 %	50 %	
P39	Max. Speed	50-100 %	100 %	
P39	Delta T	2-20	5	
P40	Circulator anti-block	Yes/No	Yes	
P40	Flow switch	0-1	0	
P40	Reduction enable	NO/YES	No	
P40	Power	50-100 %	75 %	
P41	Model	Audax 6/ Audax 8 / Audax 12/ Audax 16 /Audax 16 Mono / Audax Top 18 / Audax Top 21		
P41	Start	Yes/no	No	
P42	Scan Start	Yes/no	No	
P43	Ind. 11	Audax 6/ Audax 8 / Audax 12/ Audax 16 /Audax 16 Mono / Audax Top 6 /Audax Top 8/Audax Top 12 / Audax Top 16 /Audax Top 18 / Audax Top 21 /Audax 6 kW/ Audax 8 – 18 kW / Magis Pro / Magis Combo / Magis M		
P43	Ind. 12	Audax 6/ Audax 8 / Audax 12/ Audax 16 /Audax 16 Mono / Audax Top 6 /Audax Top 8/Audax Top 12 / Audax Top 16 /Audax Top 18 / Audax Top 21 /Audax 6 kW/ Audax 8 – 18 kW / Magis Pro / Magis M		
P43	Ind. 13	Audax 6/ Audax 8 / Audax 12/ Audax 16 /Audax 16 Mono / Audax Top 6 /Audax Top 8/Audax Top 12 / Audax Top 16 /Audax Top 18 / Audax Top 21 /Audax 6 kW/ Audax 8 – 18 kW / Magis Pro / Magis M		

No. page	Description	Range adjustment	Value default	Value customis.
P43	Ind. 14	Audax 6/ Audax 8 / Audax 12/ Audax 16 /Audax 16 Mono / Audax Top 6 /Audax Top 8/Audax Top 12 / Audax Top 16 /Audax Top 18 / Audax Top 21 /Audax 6 kW/ Audax 8 - 18 kW / Magis Pro / Magis M		
P44	Addr	0 - 255	0	
P44	Param	0 - 32676	0	
P44	Start	Yes/no	NO	
P45	Type	Top 6-8-12-16 / Audax	Audax	
P45	New address to assign	12 - 14	12	
P45	Start	Yes/no	No	
P46	Type	Top 6-8-12-16 / Audax	Audax	
P46	Current address	12 - 14	12	
P46	Start	Yes/no	No	
P47	Magis M No. 1 - Enabling reduction	OFF/ON	OFF	
P47	Magis M No. 1 - Reduced power	1 / 8	1	
P48	Magis M No. 2 - Enabling reduction	OFF/ON	OFF	
P48	Magis M No. 2 - Reduced power	1 / 8	1	
P49	Magis M No. 3 - Enabling reduction	OFF/ON	OFF	
P49	Magis M No. 3 - Reduced power	1 / 8	1	
P50	Magis M No. 4 - Enabling reduction	OFF/ON	OFF	
P50	Magis M No. 4 - Reduced power	1 / 8	1	
P51	Power red. with contact	Yes/no	No	
P61	Pumps n.	0-2	0	
P62	Puffer Presence	Yes/no	No	
P62	Pre-heating	Yes/no	No	
P62	Zone Activation On Request	Upon Request / In temperature	In tempera- ture	
P63	Puffer - Hyst. ON	-10 - +20	1	
P63	Puffer - Hyst. OFF	-10 - +20	4	
P63	Puffer - Offset gen	-10 - +30	6	
P63	Puffer - Offset DHW	0 - 10	10	
P64	Thermal discharge enable	Yes/no	No	
P64	Insert Temp.	10-99	55	
P64	Delta Temp.	0-99	10	
P65	Separate management heating/cooling	Yes/no	No	
P65	Generator OFF enable	Yes/no	No	
P66	Plant decoup	Yes/no	No	
P66	Probe plant	Yes/no	No	
P66	Photovoltaic	Yes/no	No	

No. page	Description	Range adjustment	Value default	Value customis.
P67	Puffer Presence	NO/YES	No	
P67	Maintain:	NO/YES	No	
P67	Pump	NO/YES	No	
P67	Zone Activation On Request	Upon Request / In temperature	In temperature	
P68	Central Heating - Hyst. ON	-10 - +20	1	
P68	Central Heating - Hyst. OFF	-10 - +20	4	
P68	Central Heating - Offset gen	-10 - +30	6	
P69	Puffer Cooling - Hyst. ON	-10 - +20	1	
P69	Puffer Cooling - Hyst. OFF	-10 - +20	4	
P69	Puffer Cooling - Offset gen	-10 - +30	6	
P81	Setpoint corr. Delivery probe - Act. time	1-120	10	
P81	Setpoint corr. Delivery probe - Incr. time	1-20	3	
P82	Setpoint corr. Delivery p. - Max corr. Heat	0-10	0	
P82	Setpoint corr. Delivery p. - Min corr. Cool	-10 - 0	0	
P83	Setpoint corr. Delivery probe - Act. time	1-120	20	
P83	Setpoint corr. Delivery probe - Incr. time	1-20	5	
P84	Setpoint corr. Delivery p. - Max corr. Heat	0-10	2	
P84	Setpoint corr. Delivery p. - Min corr. Cool	-10 - 0	0	

“Assistance \ Temperature control” Menu.

No. page	Description	Range adjustment	Value default	Value customis.
T01	Enable external temperature probe	Not used, From heat pump, From boiler, From system manager	Not used	
T02	Room probe	Yes/No	Yes	
T02	Zone 01 - Heating phase External probe	No/Yes	No	
T02	Zone 01 - Heating phase Set min	20 – 85*	25	
T02	Zone 01 - Heating phase Set max	20 – 85*	45	
T03	Room probe	Yes/No	Yes	
T03	Zone 02 - Heating phase External probe	No/Yes	No	
T03	Zone 02 - Heating phase Set min	20 – 85*	25	
T03	Zone 02 - Heating phase Set max	20 – 85*	45	
T04	Room probe	Yes/No	Yes	
T04	Zone 01 - Heating phase External probe	No/Yes	No	
T04	Zone 03 - Heating phase Set min	20 – 85*	25	
T04	Zone 03 - Heating phase Set max	20 – 85*	45	
T05	Room probe	Yes/No	Yes	
T05	Zone 01 - Heating phase External probe	No/Yes	No	
T05	Zone 04 - Heating phase Set min	20 – 85*	25	
T05	Zone 04 - Heating phase Set max	20 – 85*	45	
T06	Room probe	Yes/No	Yes	
T06	Zone 01 - Heating phase External probe	No/Yes	No	

No. page	Description	Range adjustment	Value default	Value customis.
T06	Zone 05 - Heating phase Set min	20 – 85*	25	
T06	Zone 05 - Heating phase Set max	20 – 85*	45	
T07	Room probe	Yes/No	Yes	
T07	Zone 01 - Heating phase External probe	No/Yes	No	
T07	Zone 06 - Heating phase Set min	20 – 85*	25	
T07	Zone 06 - Heating phase Set max	20 – 85*	45	
T08	Room probe	Yes/No	Yes	
T08	Zone 01 - Heating phase External probe	No/Yes	No	
T08	Zone 07 - Heating phase Set min	20 – 85*	25	
T08	Zone 07 - Heating phase Set max	20 – 85*	45	
T09	Room probe	Yes/No	Yes	
T09	Zone 01 - Heating phase External probe	No/Yes	No	
T09	Zone 08 - Heating phase Set min	20 – 85*	25	
T09	Zone 08 - Heating phase Set max	20 – 85*	45	
T10	Room probe	Yes/No	Yes	
T10	External t. limit - Heating phase Min ext.	-20 - 0	-5	
T10	External t. limit - Heating phase Max ext.	+5 - +25	25	
T11	Room probe	Yes/No	Yes	
T11	Zone 01 - Heating phase Set min	5 – 25*	18	
T11	Zone 01 - Heating phase Set max	5 – 25*	20	
T12	Room probe	Yes/No	Yes	
T12	Zone 02 - Heating phase Set min	5 – 25*	18	
T12	Zone 02 - Heating phase Set max	5 – 25*	20	
T13	Room probe	Yes/No	Yes	
T13	Zone 03 - Heating phase Set min	5 – 25*	18	
T13	Zone 03 - Heating phase Set max	5 – 25*	20	
T14	Room probe	Yes/No	Yes	
T14	Zone 04 - Heating phase Set min	5 – 25*	18	
T14	Zone 04 - Heating phase Set max	5 – 25*	20	
T15	Room probe	Yes/No	Yes	
T15	Zone 05 - Heating phase Set min	5 – 25*	18	
T15	Zone 05 - Heating phase Set max	5 – 25*	20	
T16	Room probe	Yes/No	Yes	
T16	Zone 06 - Heating phase Set min	5 – 25*	18	
T16	Zone 06 - Heating phase Set max	5 – 25*	20	
T17	Room probe	Yes/No	Yes	
T17	Zone 07 - Heating phase Set min	5 – 25*	18	
T17	Zone 07 - Heating phase Set max	5 – 25*	20	
T18	Room probe	Yes/No	Yes	
T18	Zone 08 - Heating phase Set min	5 – 25*	18	
T18	Zone 08 - Heating phase Set max	5 – 25*	20	
T19	Room probe	Yes/No	Yes	
T19	External t. limit - Heating phase Min ext.	20-35	25	
T19	External t. limit - Heating phase Max ext.	25-40	35	

No. page	Description	Range adjustment	Value default	Value customis.
T20	Room probe	Yes/No	Yes	
T20	Zone 01 - Heating phase External probe	No/Yes	No	
T20	Set min	20 - 85*	25	
T20	Set max	20 - 85*	45	
T21	External t. limit - Heating phase Min ext.	-20 - 0	-5	
T21	External t. limit - Heating phase Max ext.	5 - 25	25	
T22	Set Deum. Neutral Air	5 - 25	20	

* = the range can be reduced based on the type of generator installed

“Assistance \ DHW” menu.

No. page	Description	Range adjustment	Value default	Value customis.
Q01	DHW set hysteresis	3 - 12	5	
Q01	Puffer - Offset DHW	2 - 30	10	
Q02	DHW circuit	Split / Shared	Shared	
Q02	DHW simultaneous	No / Yes	No	
Q02	Priority	Dhw/Plant	DHW	
Q03	Anti-legionel Enable	No / Yes	No	
Q03	Anti-legionel Day	Monday, Tuesday, Wednesday, Thursday, Friday, Saturday, Sunday	Monday	
Q03	Anti-legionel Hour	00:00 - 24:00	07:00	
Q04	Recycle Pump Enable	No / Yes	No	
Q04	Start T. Band 1	00:00 - 24:00	00:00	
Q04	End T. Band 1	00:00 - 24:00	00:00	
Q04	Start T. Band 2	00:00 - 24:00	00:00	
Q04	End T. Band 2	00:00 - 24:00	00:00	
Q05	Max duration alarm DHW	1-48	5	
Q05	Max duration alarm Anti-legionel	1-48	3	

“Assistance \ Solar” menu.

n° pagina	Description	Range adjustment	Value default	Value customis.
W01	Solar pump 1 Δt On	1 - 20	6	
W01	Solar pump 1 Δt Off	0,5 - 19,5	4	
W02	Solar pump 2 Δt On	1 - 20	6	
W02	Solar pump 2 Δt Off	0,5 - 19,5	4	
W03	Tank Max. temp.	20 - 90	70	
W04	Tank Cooling Enable	Yes/No	No	
W05	Collector Max. temp	110 - 190	140	
W06	Collector Cooling Enable	Yes/No	no	
W06	Collector Cooling Max. T.	110 - 190	120	
W07	Collector Min. Temperature Enable	Yes/No	no	
W07	Collector Min. Temperature Min. T.	10 - 90	10	
W08	Collector Antifreeze Prot. Enable	Yes/No	no	
W08	Collector Antifreeze Prot. Min. T.	-10 - +10	4	
W09	Solar return probe Enable	Yes/No	No	

“Assistance \ Integration” menu.

No. page	Description	Range adjustment	Value default	Value customis.
X01	Integration info Disp.	---, Boiler bms, Boiler imgbus, Boiler on/off, Boiler 0-5v, Boiler 0-10v, el. Heater (Magis Combo A, Magis Combo B)	---	
X01	Integration info Integr.	Contemporary/Alternate	Alternate	
X02	DHW	Only HP / HP + boiler/ only boiler / HP + EH / only EH	Only HP	
X02	Central heating	Only HP / HP + boiler/ only boiler / HP + EH / only EH	Only HP	
X03	Heat time delay	1 - 540 min	30	
X03	San. time delay	1 - 540 min	45	
X04	Integr. Limit	0 - 20	3	
X04	Minimum temperature of Integration	-20 - +35	-15,0	
X04	Integration Mult.	0,1 - 99,0	3,0	
X05	Boiler Integr. with ext. probe link Offset	0 - 15	0	
X06	Boiler forced in DHW	10 - 60	10	
X07	Victrix Pro Set Max	20 - 85	85	
X07	Victrix Pro Set Min	20 - 85	20	

“Assistance \ Supervisor” menu.

No. page	Description	Range adjustment	Value default	Value customis.
B01	Digital Mangement Sys Enable	No / Yes	No	
B02	Protocol supervision system 1	---, Carel, Modem RS 232, Modbus, Winload	Winload	
B02	Baudrate supervision system 1	1200, 2400, 4800, 9600, 19200	19200	
B02	Address supervision system 1	1 - 100	1	
B03	Protocol supervision system 2	---, Carel, Modem RS 232, Modbus, Winload	Winload	
B03	Baudrate supervision system 2	1200, 2400, 4800, 9600, 19200	19200	
B03	Address supervision system 2	1 - 100	1	
B04	Dominus Enable	NO/YES	No	

“Assistance \ Reset” menu.

No. page	Description	Range adjustment	Value default	Value customis.
R01	Heating pump	NO/YES	No	
R01	Heat pump 2	NO/YES	No	
R01	Heat pump 3	NO/YES	No	
R01	Heat pump 4	NO/YES	No	
R02	Solar pump 1	NO/YES	No	
R02	Solar pump 2	NO/YES	No	
R03	DHW Heater	NO/YES	No	
R03	Plant Heater	NO/YES	No	
R03	Puffer Pump	NO/YES	No	

“Assistance \ Manual management” menu.

No. page	Description	Range adjustment	Value default	Value customis.
A02	Solar pump 1	OFF/ON		
A02	Solar pump 1	OFF/ON		
A03	DHW Dev	OFF/ON		
A03	Boiler: Central heating request	25 - 85		
A03	Boiler: Set Central heating	OFF/ON		
A04	Boiler: DHW Request	OFF/ON		
A04	El. Resistance: Res. System	OFF/ON		
A05	El. Resistance: Res. DHW	OFF/ON		
A05	Puffer: Int. Dhw	OFF/ON		
A05	Puffer: Int. Central heating	OFF/ON		
A11	Puffer: System Pump	OFF/ON		
A11	Expansion 1: Zone pump	STOP/OPEN/ CLOSE		
A11	Expansion 1: 3P Valve	OFF/ON		
A11	Expansion 1: Dehumidification	OFF/ON		
A12	Expansion 1: Deh. and Clim.	OFF/ON		

No. page	Description	Range adjustment	Value default	Value customis.
A12	Expansion 2: Zone pump	STOP/OPEN/ CLOSE		
A12	Expansion 2: 3P Valve	OFF/ON		
A12	Expansion 2: Dehumidification	OFF/ON		
A13	Expansion 2: Deh. and Clim.	OFF/ON		
A13	Expansion 3: Zone pump	STOP/OPEN/ CLOSE		
A13	Expansion 3: 3P Valve	OFF/ON		
A13	Expansion 3: Dehumidification	OFF/ON		
A14	Expansion 3: Deh. and Clim.	OFF/ON		
A14	Expansion 4: Solar pump 2	OFF/ON		
A15	Expansion 5: Valv. Hot/Cold	OFF/ON		
A15	Expansion 5: Valv. Hot/Cold	OFF/ON		
A15	Expansion 5: Recirculation Pump	OFF/ON		
A15	Expansion 5: Thermal Discharge	OFF/ON		
A16	Expansion 5: Decoupled circ.	OFF/ON		
A16	Expansion 6: Zone pump	STOP/OPEN/ CLOSE		
A16	Expansion 6: 3P Valve	OFF/ON		
A16	Expansion 6: Dehumidification	OFF/ON		
A17	Expansion 6: Deh. and Clim.	OFF/ON		
A17	Expansion 7: Zone pump	STOP/OPEN/ CLOSE		
A17	Expansion 7: 3P Valve	OFF/ON		
A17	Expansion 7: Dehumidification	OFF/ON		
A18	Expansion 7: Deh. and Clim.	OFF/ON		
A18	Expansion 8: Zone pump	STOP/OPEN/ CLOSE		
A18	Expansion 8: 3P Valve	OFF/ON		
A18	Expansion 8: Dehumidification	OFF/ON		
A19	Expansion 8: Deh. and Clim.	OFF/ON		
A19	Expansion 9: Zone pump	STOP/OPEN/ CLOSE		
A19	Expansion 9: 3P Valve	OFF/ON		
A19	Expansion 9: Dehumidification	OFF/ON		
A20	Expansion 9: Deh. and Clim.	OFF/ON		
A20	Expansion 10: Zone pump	STOP/OPEN/ CLOSE		
A20	Expansion 10: 3P Valve	OFF/ON		
A20	Expansion 10: Dehumidification	OFF/ON		
A21	Expansion 10: Deh. and Clim.	0 - 100		
A22	Audax 1: Circ. Test Speed	Off, Cooling Test, Heating Test, Ramp Cooling Test, Ramp Heating Test		

No. page	Description	Range adjustment	Value default	Value customis.
A22	Audax 1: Mode	-120 - 120		
A23	Audax 1: Set Freq.	NO/YES		
A31	Audax 1: High pressure switch test	0 - 100		
A32	Audax 2: Circ. Test Speed	Off, Cooling Test, Heating Test, Ramp Cooling Test, Ramp Heating Test		
A32	Audax 2: Mode	-120 - 120		
A33	Audax 2: Set Freq.	NO/YES		
A41	Audax 2: High pressure switch test	NO/YES		
A42	Audax 3: Circ. Test Speed	Off, Cooling Test, Heating Test, Ramp Cooling Test, Ramp Heating Test		
A42	Audax 3: Mode	-120 - 120		
A43	Audax 3: Set Freq.	NO/YES		
A51	Audax 3: High pressure switch test	NO/YES		
A52	Audax 4: Circ. Test Speed	Off, Cooling Test, Heating Test, Ramp Cooling Test, Ramp Heating Test		
A52	Audax 4: Mode	-120 - 120		
A53	Audax 4: Set Freq.	NO/YES		

“Assistance \ Heat pump set” menu.

No. page	Description	Range adjustment	Value default	Value customis.
C01	Heat / Cool mode	Cascade, Simultaneous	Cascade	
C01	DHW mode	Cascade, Simultaneous	Cascade	
C02	Activation band to start or stop H.P.	1 - 10 °C	6,0	
C03	Heat / Cool mode Activat. time	0-120 m	15	
C03	Heat / Cool mode Deactiv. time	0-120 m	10	
C04	DHW mode Activat. time	0-120 m	15	
C04	DHW mode Deactiv. time	0-120 m	10	
C05	Period used to reverse	0 - 7	7	

7 NOTES FOR DEVICES FOR ZONES

7.1 NOTES FOR ZONE CONTROL

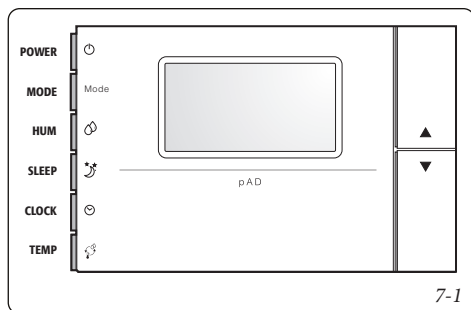

N.B.: The zone controls must be configured so that they work correctly with the system manager, and the address in particular must be set up using the following procedure:

- 1 - press the UP key;
- 2 - within three seconds press the DOWN key;
- 3 - when the term “PAR” appears on the main area, release the DOWN key keeping the UP key down and press the TEMP key within three seconds.

Procedure to change parameters

In this mode, all symbols are shut off, except for the following fields:

888 indicates the value of the parameter currently being changed;

88:88 indicates the name of the parameter currently being changed.

To set the parameters proceed as follows:

- 1 - The field **88:88** is flashing. Select the parameter you need to change using the UP/DOWN keys, then press TEMP.
- 2 - The field **88:88** is flashing. Set the desired value using the UP/DOWN keys, then press TEMP.
- 3 - Repeat the actions from point 1 to complete all of the desired operations.
- 4 - To exit parameter change and save the changes that have been made, simply keep TEMP pressed down for 3 seconds.

To exit parameter change without saving the changes that have been made, simply wait 60 seconds after pressing the last key, or press SLEEP. 45 seconds after pressing the last key the name of the parameter or the numerical value will flash. If the parameters regarding communication (Ad01) are changed, communication will be re-initialised from the zone control.

Below we provide the meanings for the operating parameters:

Ad01 - Network address for the zone control (1÷32)
- Default 2;

Ad02 - Supervisor address - (**Do not change**)

Br01 - Baud rate - (**Do not change**)

Br02 - Baud rate supervision - (**Do not change**)

En01 - Enable buzzer (0÷1) - Default 1.

Pc01 - Room probe calibration - (**Do not change**)

rEL - Release firmware indication - (**Do not change**)

Prot - Select protocol - (**Do not change**)

The addresses to be used are:

21 = Zone 1

22 = Zone 2

23 = Zone 3

24 = Zone AT

When configuration is complete, restart the control zone by shutting off and turning the electric power supply back on.

N.B.: The zone control cannot be used to programme the time periods, which can only be programmed on system manager, but it will be possible to manage the request to operate the zone being referred to manually by setting the desired set.

7.2 NOTES FOR ZONE REMOTE CONTROL

Please refer to the relevant instructions sheet for installation instructions. The required addresses to use are:

- 31 = Zone 1
- 32 = Zone 2
- 33 = Zone 3
- 34 = Zone AT

On the zone remote control it is possible to set:

- the operating mode;
- the room set point;
- room humidity set point.

The following can also be displayed:

- zone room temperature;
- relative humidity;
- current DHW set;
- zone flow set;
- generic alarm signal;
- activation of:
 - heat pump;
 - boiler;
 - zone antifreeze;
 - zone pump;
 - zone dehumidification.

The zone remote control manages the heating/cooling of the associated zone.

The functions valid for the secondary remote zone control are enabled with:

- Buttons to the side of the display (*Ref. 2 - 3 Fig. 7-2*) allow to select the available functions.
- main switch (*Ref. 1 Fig. 7-2*) by turning it one can select the values of the parameters. The parameter being edited flashes, to store the selected value press the main selector.

Programming current time and day. Press and hold the “time band ⌚” button until the “CLOC” function appears.

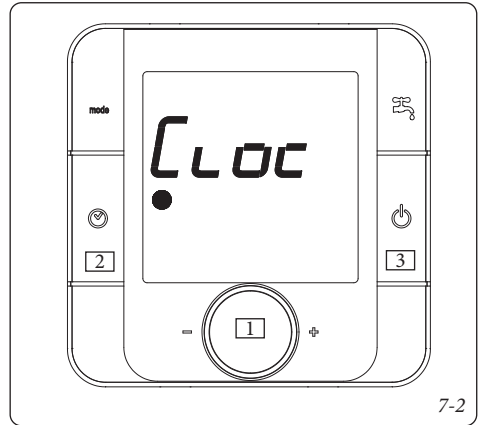

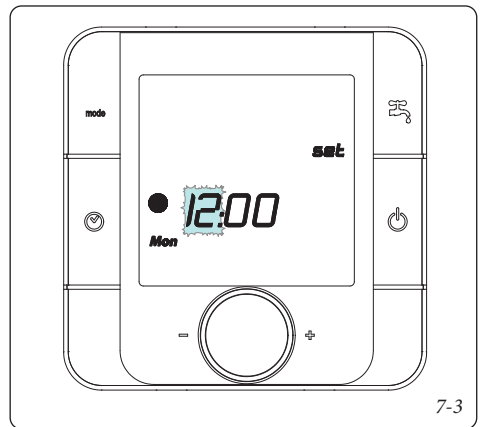

Select the function and adjust it according to the current time and day.



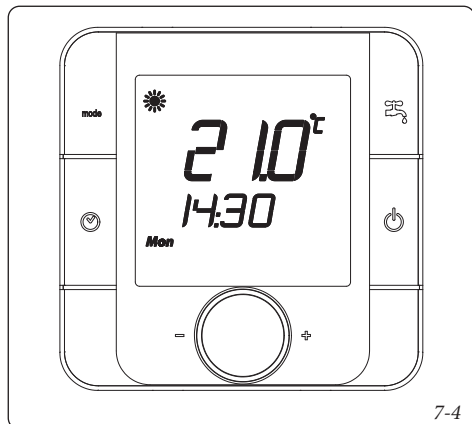

Ignition. Press and hold the “on / off ” button; the remote control goes into stand-by and displays the operating modes, the room temperature and the time.



Operating mode selection. By pressing the “Mode mode” button one can select the operating mode of the system in cyclic mode between:

- “Summer with cooling ”, system operating in room cooling (performed by the heat pump) and domestic hot water production mode.
- “Winter ”, system operating in room heating and domestic hot water production mode.
- “Domestic hot water ”, system operating in domestic hot water production mode only.

Time slots adjustment. The “Time band” parameter enables to adjust the room temperatures in time slots, it is possible to adjust up to a maximum of 6 time slots and the programming can be set day by day for the whole week, for 5 days (Mon-Fri) and 2 days (Sat-Sun).

Press and hold the “time band ” button until the “” function appears, turn the main selector until the “” parameter appears

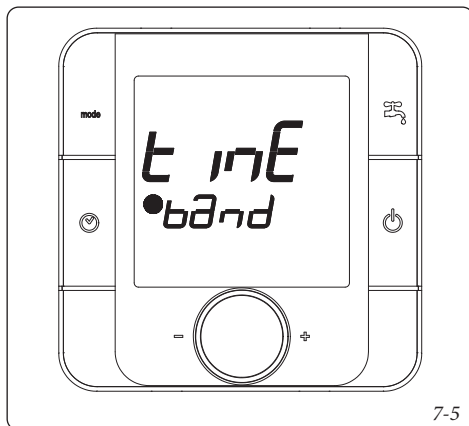

Select the function and adjust the time slots.

- Select the interval of days that one wishes to program, the days being programmed flash.

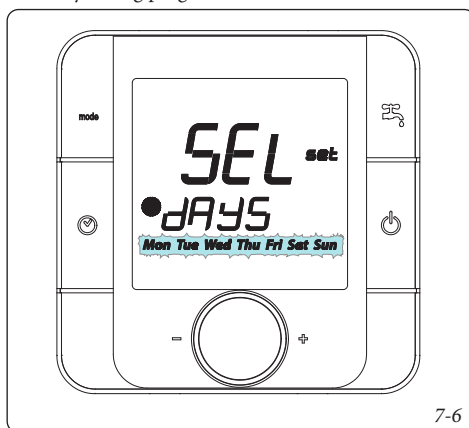

- Select the time slots, which are shown according to the sequence below:



- Then select the temperature for that time slot.

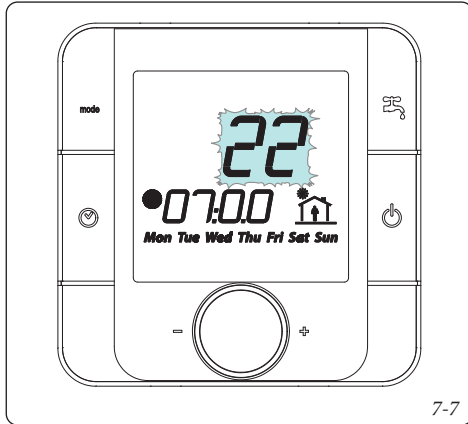

N.B.: when selecting the temperature relating to the time slot, one can also set the boiler in OFF mode “ $\square F F$ ” that allows to switch the boiler off in the pre-set time interval.

Repeat the operations for all the time slots and for the days required.

To exit the time slot programming mode wait for a few seconds or turn the selector until “ $\text{E } 5 \text{ E}$ ” appears and press the main selector.

Time slot activation. By pressing the button “ \odot ” one can activate system operation according to the settings made previously. The activation of the time slot mode is signalled by the activation of the relative symbol “ \bullet ”. To disable the function and enable manual operation press the button “ \odot ” again. In case of time slots disabling from OFF mode, a new room set must be restored.

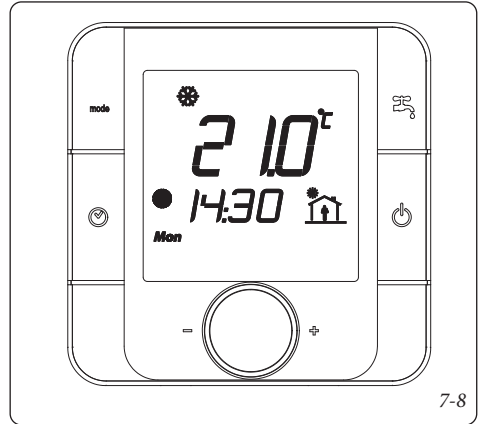

Function lock. In conjunction with the activation of the time slots, the manual room temperature control mode is disabled; this status is signalled by the activation of the relative symbol “ \bullet ”.

Room temperature manual adjustment. In the event the time slots are not used, one can set the room temperature simply by turning the main selector.

Once the required room temperature is set, the display will go back to showing the measured room temperature.

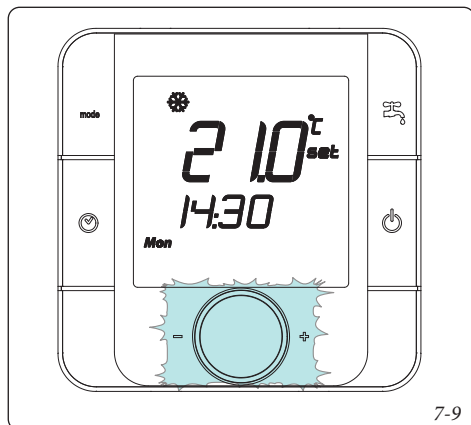

Anomalies display. In the event there is an anomaly in progress, the remote control displays the status via the symbol "▲".

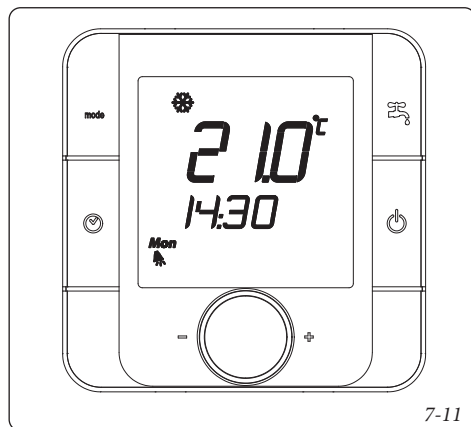

Room humidity adjustment. To display the humidity in the room, press the main selector, during the display of the humidity one can change the desired humidity value, simply by turning the main switch.

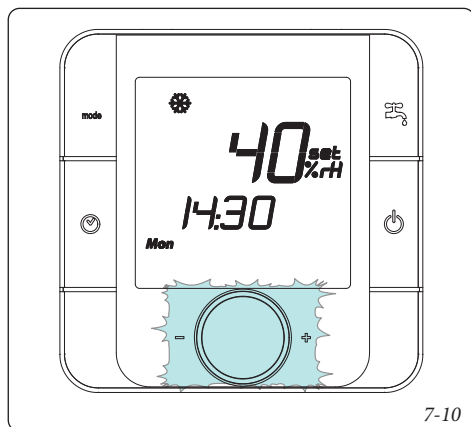

By pressing the new selector, the zone flow set and the system active dhw set can be displayed.

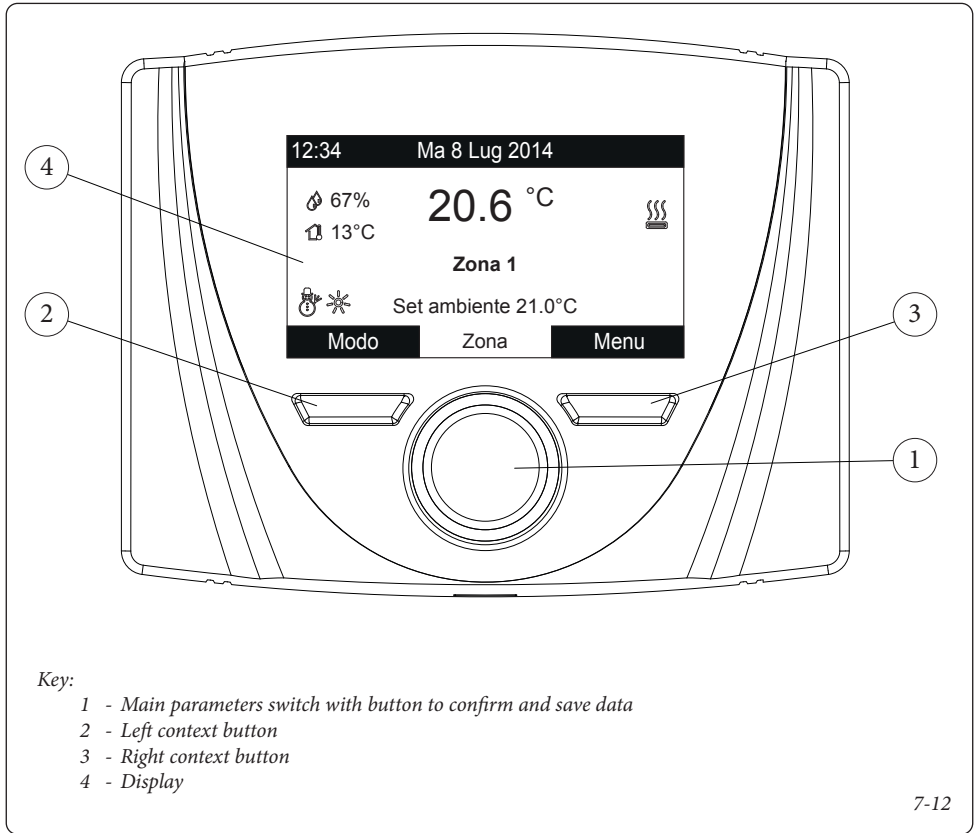

7.3 NOTES FOR THE ZONE REMOTE PANEL

Please refer to the relevant instructions sheet for installation and use instructions. The required addresses to use are:

- 41 = Zone 1
- 42 = Zone 2
- 43 = Zone 3
- 44 = Zone AT

The communication parameters are:

- Baudrate = 9600
- Parity bits = None
- Stop Bits = 2

These parameters can be found in:
Menu\Service\Device Conf.

7.4 NOTES FOR DOMINUS (OPTIONAL).

The system can be remote controlled using the optional Dominus kit.

Make the connection to the appliance as shown (Wiring diagram Parag. 9.35).

The following is necessary to enable Dominus:

- position the Dip Switches: OFF-OFF-OFF-OFF;
- set the System supervision parameter on the control panel = Domin;
- configure the profile of the Dominus APP on System Manager or alternatively on Magis Pro-Combo V2.

The Dominus firmware must be updated to at least revision 2.02.

For further information, consult the relative instruction sheet.

8 GENERATORS CONFIGURATION

8.1 HEAT PUMPS CONFIGURATION.

8.1.1 Communication analysis

Scan Modbus (P42, P43).

With this function it is possible to verify the presence of installed heat pumps.

- **Start Scan (P42).** It enables the machine scanning function.

The result of this operation is shown in the next page:

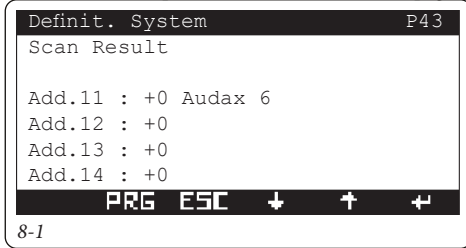

8-1

Modbus Analysis (P44).

With the following function it is possible to interrogate the devices present in the MODBUS communication bus.

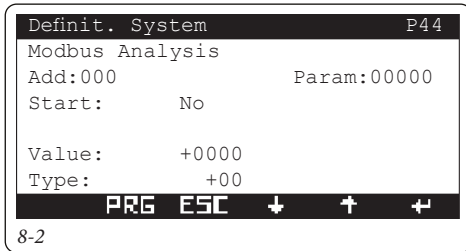

8-2

- **Ind.** Device address.
- **Param.** Parameter to be read.
- **Start.** Start reading.
- **Value.** Value of the interrogation.
- **Type.** Result of the interrogation.

For details, contact After-Sales Technical Assistance Service.

8.1.2 Magis Pro V2 configuration

Parameter **T02** and the parameter families **UXX**, **RXX**, **IXX** are automatically set by the system operator.

Required settings on the indoor unit panel:

- A12 = OFF;
- A13 = 1;

Machine	Address
Heat pump 1	11
Heat pump 2	12
Heat pump 3	13
Heat pump 4	14

- A21 =

- A22 = OFF;

Refer to the Magis Pro instruction manual to select the size of the generator.

The range for integration and precedence times are reduced to:

- 10 - 240 minutes
- **Two-pipe connection (P32).** The device is used by connecting only the flow and return pipes.
- **Four-pipe connection (P32).** The unit is operated by connecting the system and sanitary flow and return pipes.

If optional external probe is used:

- connect the optional external probe to Magis Pro.
- Select R01 = IU.
- Disconnect and reconnect power supply from the device.

8.1.3 Magis Combo V2 configuration

Parameter **T02** and the parameter families **UXX**, **RXX**, **IXX** are automatically set by the system operator.

Required settings on the indoor unit panel:

- A12 = OFF;
- A13 = 1;
- A21 = 11;
- A22 = OFF;

Refer to the Magis Combo instruction manual to select the size of the generator.

The range for integration and precedence times are reduced to:

- 10 - 240 minutes

If optional external probe, connected to Magis Combo is used:

- connect the optional external probe to Magis Combo.
- Select R01 = IU.
- Disconnect and reconnect power supply from the device.

You can choose the application type of Magis Combo (P32):

- Type A;
- Type B.

8.1.4 Magis M configuration

For correct operation of the System Manager with Magis M, it is ALWAYS necessary to install the Magis M hybrid system coupling resistor (supplied as standard with Magis M), as shown in the wiring diagrams in Chapter 9.

Most of the parameters required for the correct operation of Magis M are set automatically by the System Manager. It is suggested to reset the factory settings on Magis M before configuring the control panel for operation with the System Manager.

The following configurations are the responsibility of the installer:

- 1.5 = NO;
- 13.1 = YES;
- 13.2 = YES;
- 15.4 = NO;
- 15.8 = NO;
- 15.10 = NO;
- 17.1 = MAIN;

Machine	Address
Heat pump 1	11
Heat pump 2	12
Heat pump 3	13
Heat pump 4	14

- 17.2 =

- 17.3 = 2.

Magis M and its connecting circuit cannot be deaerated via the deaeration function of the System Manager. Refer to the Magis M instruction manual for the deaeration operation.

The Magis M Control Panel, when the unit is combined with the System Manager, assumes a Gateway role only. The data displayed may not be real and some configurations or functionalities may generate incompatibilities and lead to machine downtime.

It is recommended that the Control Panel be installed in an area not subject to accidental interaction and that the 'Child Lock' function on the Magis M control panel be fully enabled. Refer to the control panel booklet supplied with the Magis M for a list of machine functions that should not be activated in conjunction with the System Manager.

8.1.5 Work range of heat pumps.

The maximum and minimum temperatures of the heat pumps depend on the type of machine installed.

The following tables highlight the operational limits.

	Magis M 4-16	Magis M 18-30
Max heat T	65	60
Min heat T	25	25
Min cool T	5	5
Max cool T	25	25

	Magis Pro V2	Magis Combo V2
Max heat T	65	80
Min heat T	20	20
Min cool T	5	5
Max cool T	25	25

8.2 BOILER CONFIGURATION.

The connection of boilers to the System Manager can be made in 4 different ways, which can be set on page X01 depending on the model:

- Connection via Immergas BMS (BMS boiler);
- Connection via ModBus interface (IMGBUS boiler);

- Connection via analogue signal (boiler 0-5 V/0-10 V);

- Connection via dry contact (boiler ON/OFF).

The following table shows in which mode Immergas boilers must be connected and which functions are supported:

Model Name	Connection Type	Activation of heating and DHW mode	Remote setting of heating flow set point and climatic curve	Remote setting of independent or autonomous DHW set point	Remote reading of operating parameters and faults
VICTRIX SUPERIOR PLUS VICTRIX SUPERIOR VICTRIX EXTRA VICTRIX EXTRA PLUS VICTRIX MAIOR VICTRIX MAIOR PLUS VICTRIX TERA VIP V2 VICTRIX PRO V2	BMS	✓	✓	✓	✓
VICTRIX MAIOR TT PLUS VICTRIX MAIOR TT VICTRIX KW TT PLUS VICTRIX KW TT VICTRIX TT VICTRIX TERA PLUS V2 VICTRIX TERA PLUS VICTRIX TERA V2 VICTRIX TERA VICTRIX TERA VIP VICTRIX EXA VICTRIX OMNIA VICTRIX ZEUS VICTRIX ZEUS SUPERIOR	IMGBUS	✓	✓	✓	✓
HERCULES CONDENSING HERCULES MINI CONDENSING ARES CONDENSING 32	0-5 V	✓	✓	X	X
VICTRIX PRO	0-10 V	✓	✓	X	X
ALL MODELS	ON/OFF	✓	X	X	X

With the exception of dry contact thermostats, all temperature control devices used on boilers (remote controls, wireless room probes, etc.) are not compatible with the System Manager.

The presence of the boiler is necessary if the high temperature zone is to be enabled.

If the boiler provides for operation with an independent domestic circuit (See Parag. 5.6) it is recommended to set the boiler hysteresis so that its activation in DHW mode occurs at a higher temperature than the DHW set point of the heat pump, or to use the DHW thermostat mode where applicable.

8.2.1 Connection via Immergas BMS.

Connection via Immergas BMS takes place on the terminals dedicated to BMS communication in supported products.

BMS configuration on Victrix Superior and Victrix Superior Plus.

- Menu > Service > ModBus:
- Type = BMS
- Slave address = 21
- Baud Rate = 9600 bps
- Parity Bit = None
- Stop Bit = 2

BMS configuration on Victrix Maior, Victrix Maior Plus, Victrix Extra, Victrix Extra Plus and Victrix Tera Vip V2.

- P18 = 2
- P19 = 21
- P20 = 3
- P21 = 2
- P22 = 0

BMS configuration on Victrix Pro V2.

- Menu > Technical > System Settings > ModBus Parameters:
- Address = 21
- Baud Rate = 9600 bps
- Frame = 8N2
- Menu > User > Central heating:
- Zone 1 central heating setting = 85°C

8.2.2 Connection via ModBus interface.

The connection of the boiler via the ModBus interface takes place on the terminals usually used for modulating remote controls, and does not require any additional configuration.

8.2.3 Connection via analogue 0-5 V signal.

Questa modalità prevede l'utilizzo dell'ingresso sonda esterna della caldaia per impostare il set point del riscaldamento. Su taluni modelli sono previste delle operazioni aggiuntive descritte nello schema elettrico indicato nel Parag. 9.11.

Una volta terminato il collegamento:

- check that there is no discrepancy between the set point sent by the System Manager and that received by the boiler;
- If necessary, correct these discrepancies with the parameter 'delivery offset' (X05).

8.2.4 Connection via analogue 0-10 V signal and DHW thermostat.

This mode activates heating requests via the 0-10 V input of Victrix Pro and DHW requests in ON/OFF mode via the appropriate contact. See the diagram in Parag. 9.12.

The following settings must be made on Victrix Pro:

- P22: set a suitable value for completing a DHW request;
- Set P29 = 17.

8.2.5 Connection via dry contact.

This mode is compatible with all integration devices equipped with an ON/OFF contact, i.e. in boilers not mentioned in the table or where it is not necessary to set a variable set point.

In this case, it is necessary:

- set a set point temperature in the boiler suitable for both heating and DHW operation;
- Adjust the heating power and ramp to the system and DHW heating requirements.

9 WIRING DIAGRAMS

9.1 SYSTEM MANAGER - POWER SUPPLY CONNECTION.

9-1

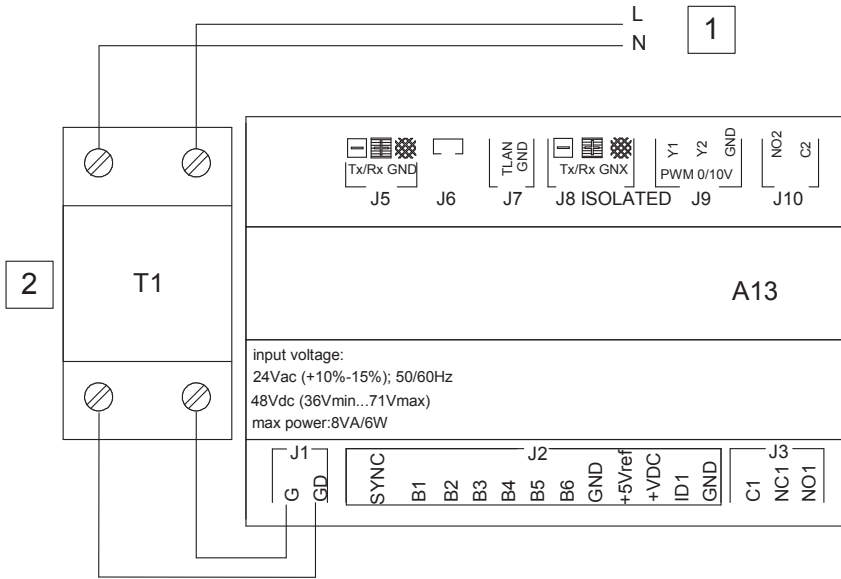

Key:

A13 - System manager

T1 - Class II transformer of at least 30 VA with 24 Vac output voltage
(not supplied with the System manager)

1 - Power supply 230 Vac - 50 Hz

2 - Transformer 230 Vac - 24 Vac

Note: - Max. power absorption 6W.

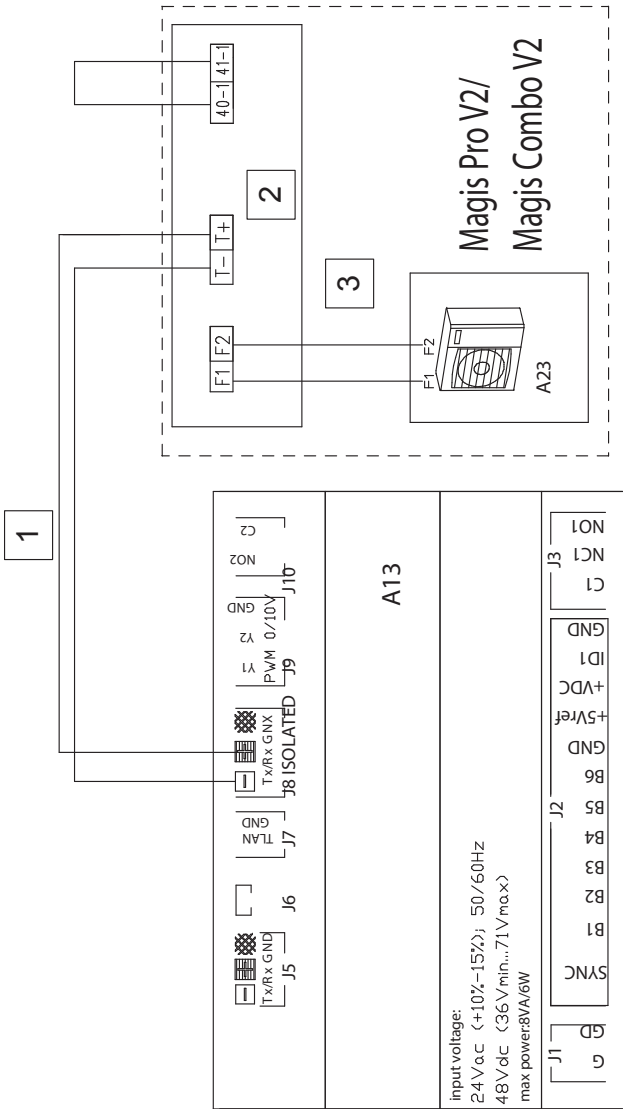

Note:
 On Magis Pro V2 / Magis Combo V2
 Set the parameters:
 A21 = 11
 A22 = OFF

- Key:
- A13 - System manager
 - A23 - Audax Pro
 - 1 - Modbus type connection AWG 20 / 22 type shielded cable
 - 2 - Indoor unit Magis Pro V2 / Magis Combo V2
 - 3 - Modbus type connection Shielded cable type AWG 20 / 22

9.3 SYSTEM OPERATOR - CONNECTION TO MAGIS M.

9-3

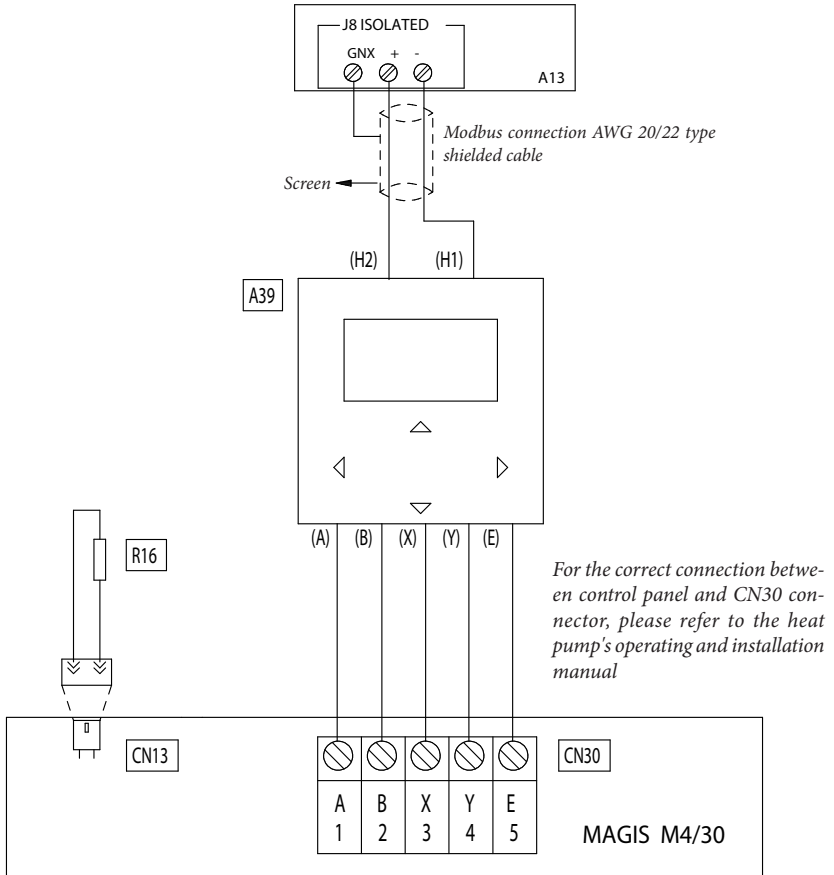

Key:

- A13 - System manager
- A39 - Control panel
- R16 - Coupling resistance
Magis M

9.4 SYSTEM MANAGER - MAGIS PRO V2 BATTERY CONNECTION

9-4

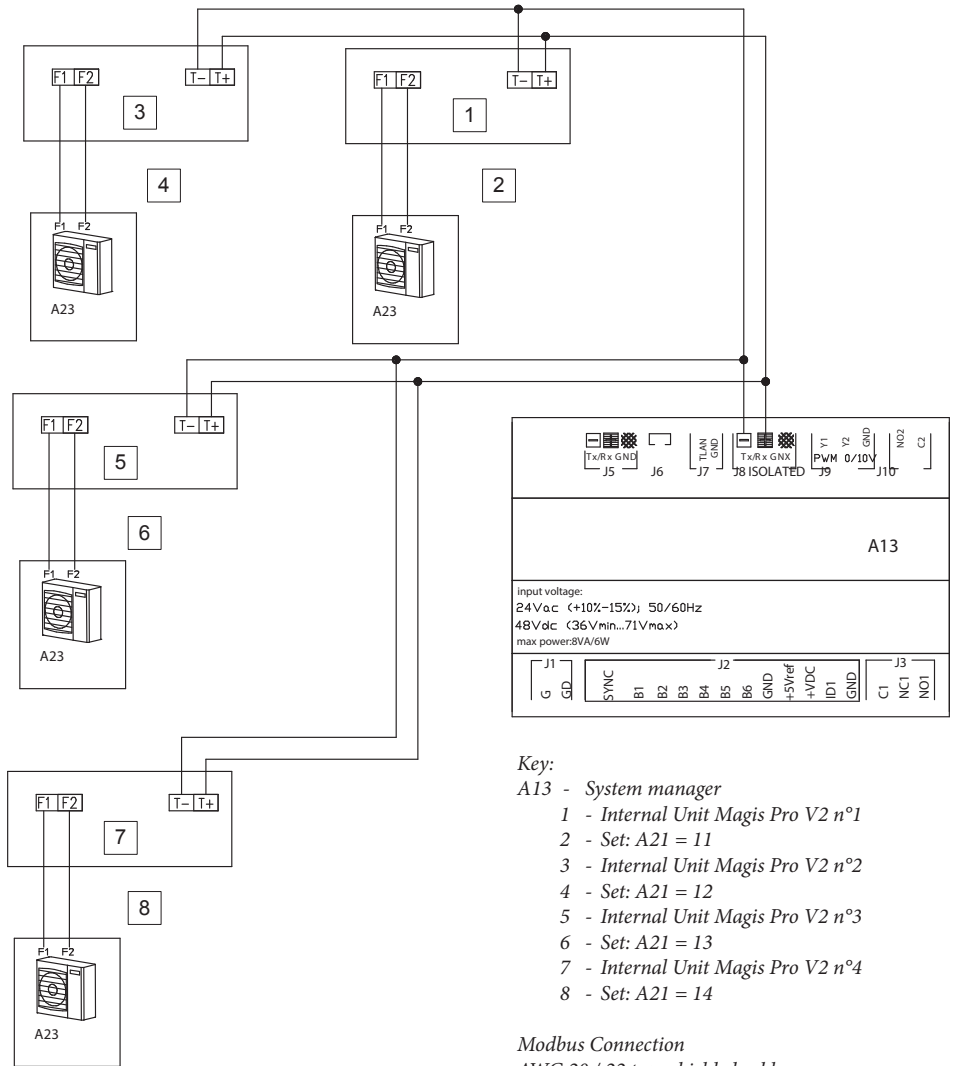

9.5 SYSTEM OPERATOR - MAGIS M BATTERY CONNECTION

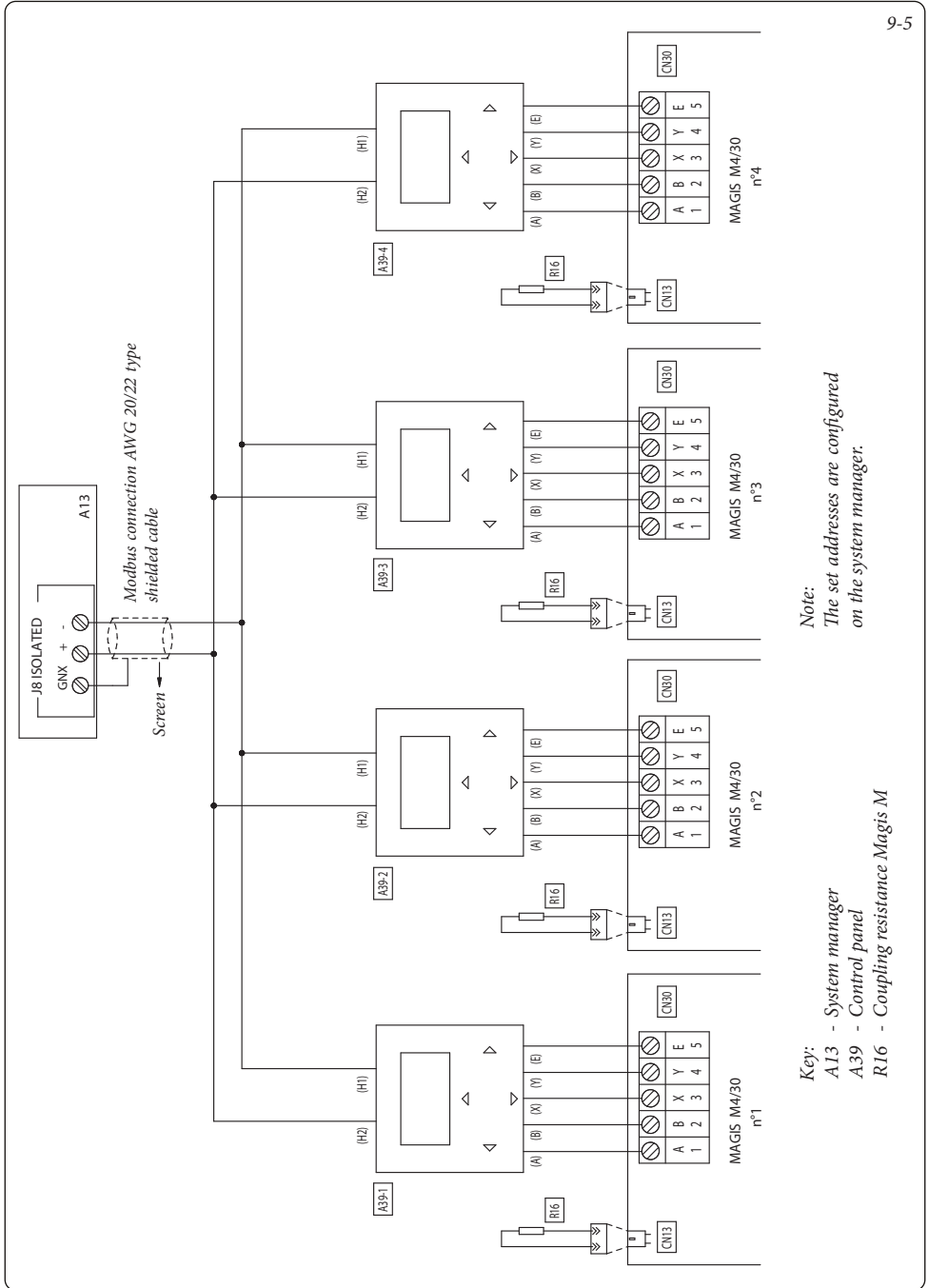

Note:
The set addresses are configured on the system manager.

Key:
A13 - System manager
A39 - Control panel
R16 - Coupling resistance Magis M

9.6 SYSTEM MANAGER - CONNECTION TO COMMON FLOW PROBE.

9-6

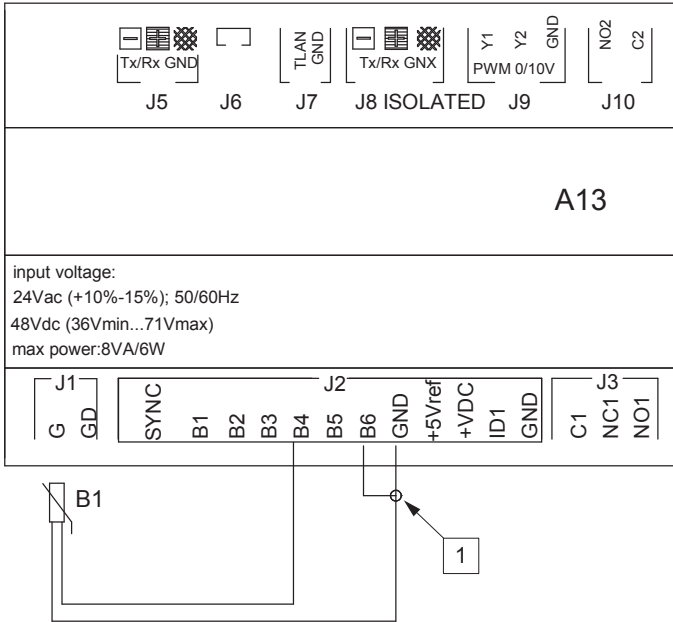

Key:

- A3 - System manager
- B1 - Common flow probe
- 1 - Input for generic boiler alarm

9.7 SYSTEM MANAGER - CONNECTION TO ELECTRIC CENTRAL HEATING INTEGRATION RESISTANCE.

Key:

9-7

- A13 - System manager
- K16 - C.H. System integration resistance relay (type SSR 6 Vdc)
- E16 - 2,4,6 kW C.H. integrative electric resistance kit
- 1 - Power supply 230V Ac

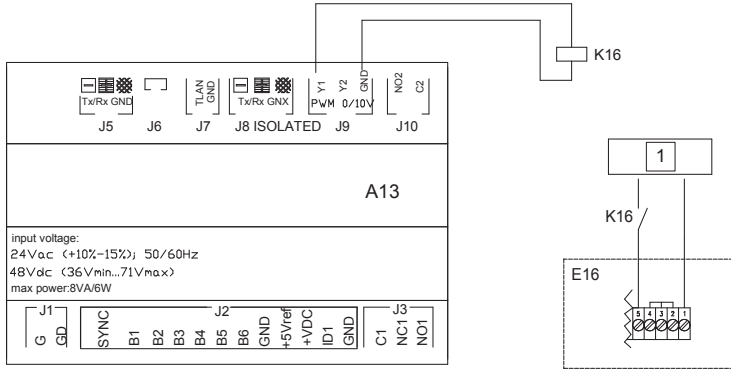

9.8 SYSTEM MANAGER - CONNECTION TO ELECTRIC DHW INTEGRATION RESISTANCE.

9-8

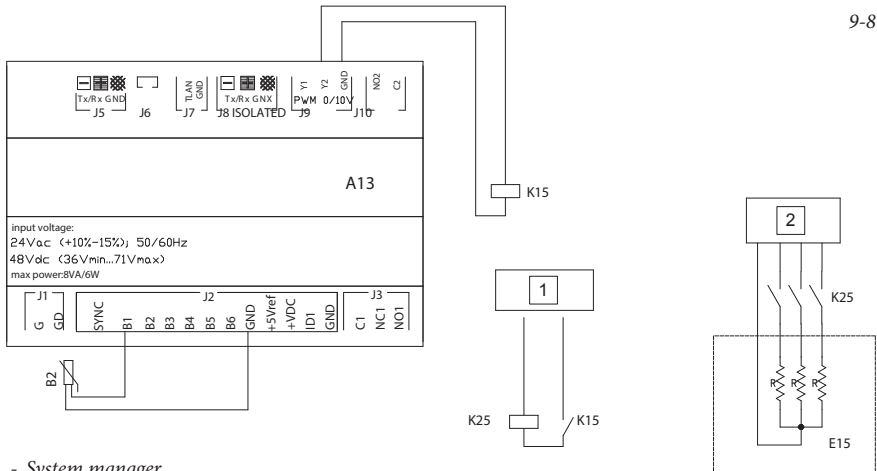

Key:

- A13: - System manager
- B2: - Storage tank probe
- E15: - Boiler unit integrative resistance
- K15: - Activation relay DHW resistance integration (type EMR 12Vdc)
- K25: - Support relay EMR 230/24 Vac 16A (not supplied)
- 1 - Power supply 230/24 Vac - 50 Hz
- 2 - Power supply 400+N/230Vac - 50 Hz

Note: - The B2 probe is fitted as standard on the Immergas storage tanks.

9.9 SYSTEM OPERATOR - CONNECTION TO VICTRIX SUPERIOR 2022.

9-9

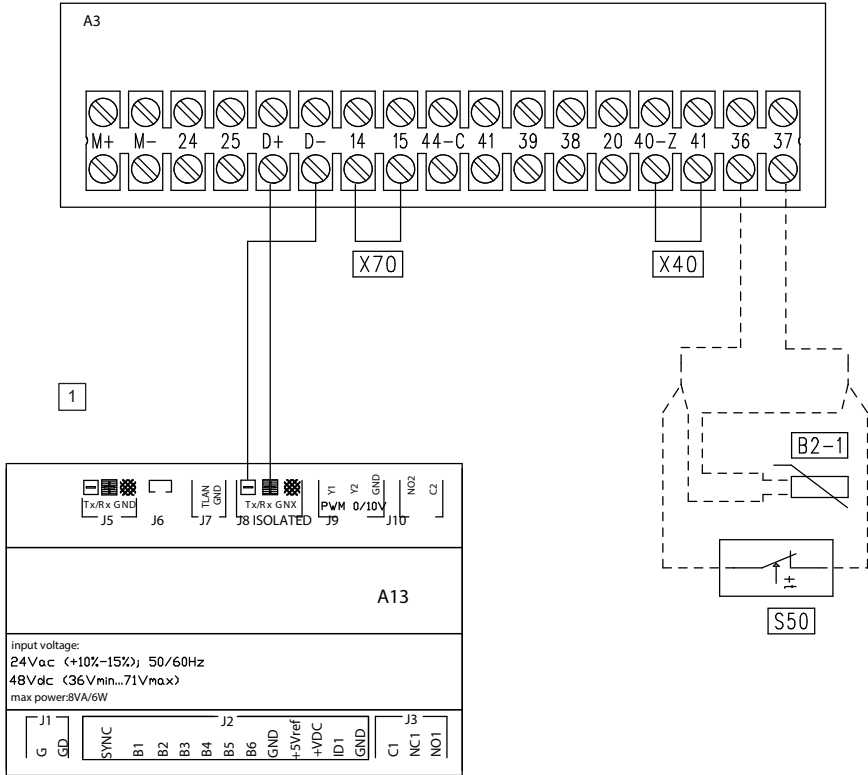

Key:

- A3: - Boiler P.C.B.
- A13: - System manager
- B2-1: - DHW probe
- S50: - DHW thermostat
- X40: - Room thermostat jumper
- X70: - Room thermostat bridge Low temperature
- 1: - Modbus connection AWG 20/22 type shielded cable

Note: - With Victrix Superior 2022 boilers, communication to operator must be activated on parameter: Menu - Service - ModBus.

9.10 SYSTEM MANAGER - CONNECTION TO VICTRIX EXTRA - VICTRIX EXTRA PLUS - VICTRIX MAIOR - VICTRIX MAIOR PLUS - VICTRIX TERA VIP V2.

9-10

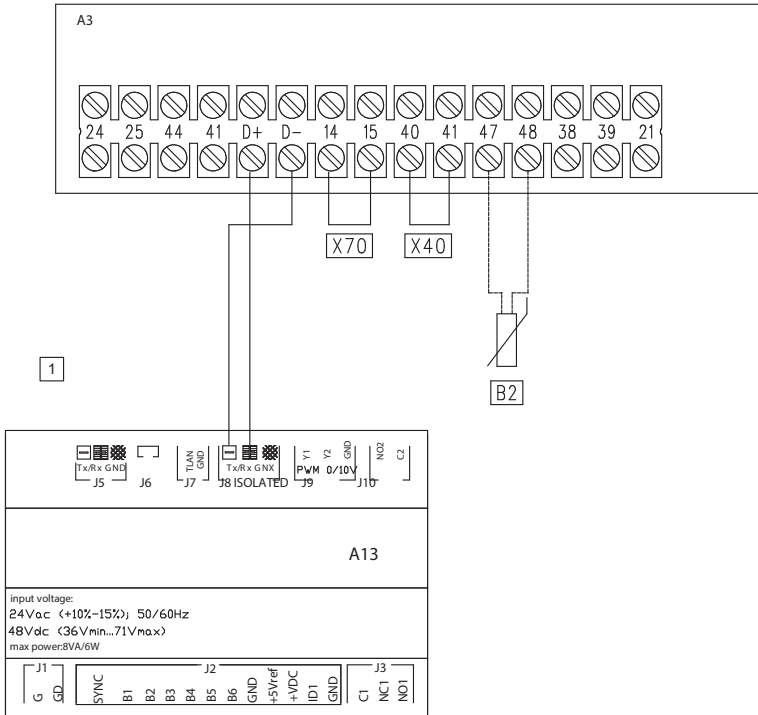

Key:

- A3: - Boiler P.C.B.
- A13 - System manager
- X70: - Room thermostat bridge Low temperature
- B2 - Boiler D.H.W. probe (Plus version only)
- 1 - Modbus connection AWG 20/22 type shielded cable

9.11 SYSTEM MANAGER - CONNECTION TO VICTRIX PRO V2.

9-11

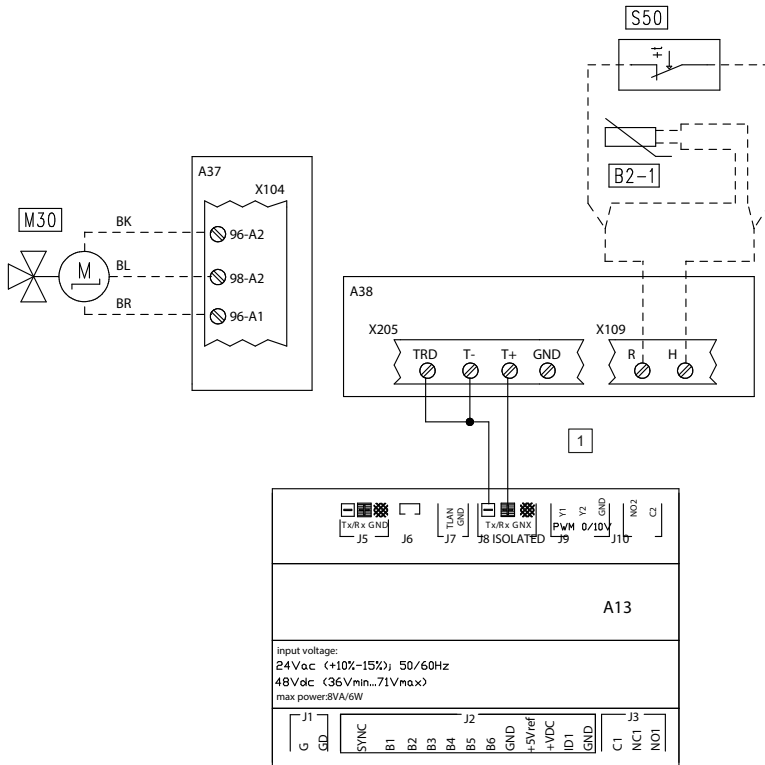

Key:

- A13 - System manager
- A37 - Connection sheet (loads)
- A38 - Connection card (signals)
- B2-1 - Independent DHW probe
- S50 - Independent DHW thermostat
- M30 - Independent DHW three-way valve
- 1 - Modbus connection AWG 20/22 type shielded cable

Colour code key:

- BK - Black
- BL - Blue
- BR - Brown

Notes: - Refer to Victrix Pro V2 instruction manual for relay configuration.

9.12 SYSTEM MANAGER - CONNECTION TO BOILER VIA MODBUS RS-485 ELECTRONIC BOARD.

9-12

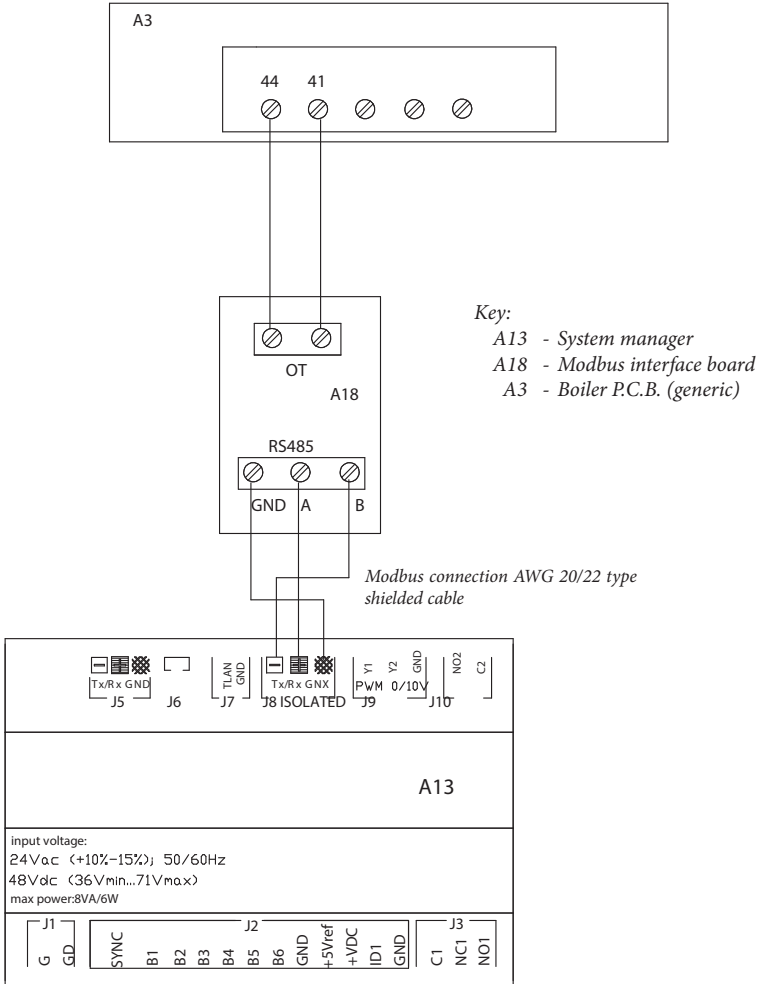

9.13 SYSTEM MANAGER - CONNECTION TO HERCULES CONDENSING ERP, HERCULES MINI CONDENSING ERP AND ARES CONDENSING 32 ERP BOILERS VIA EXTERNAL PROBE INPUT.

9-13

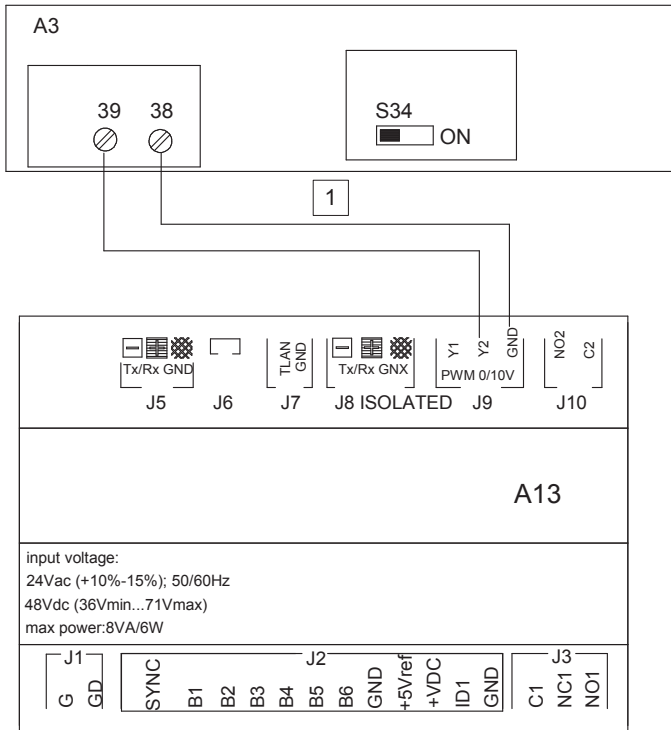

Key:

- A13 - System manager
- A3 - Boiler P.C.B.
- 1 - Cable section $\geq 1 \text{ mm}^2$

- Note:
- Set selector switch S34 to OFF to enable connection to the system manager.
 - In the boiler configuration menu after setting switch S34 = OFF, set the parameter 'ADD. EXT. P.' = 'CE'.
 - Remove any jumper TA "X40" on terminals 40 - 41 of the boiler board

9.14 SYSTEM MANAGER - CONNECTION TO VICTRIX PRO VIA 0-10 V INPUT AND SANITARY THERMOSTAT.

9-14

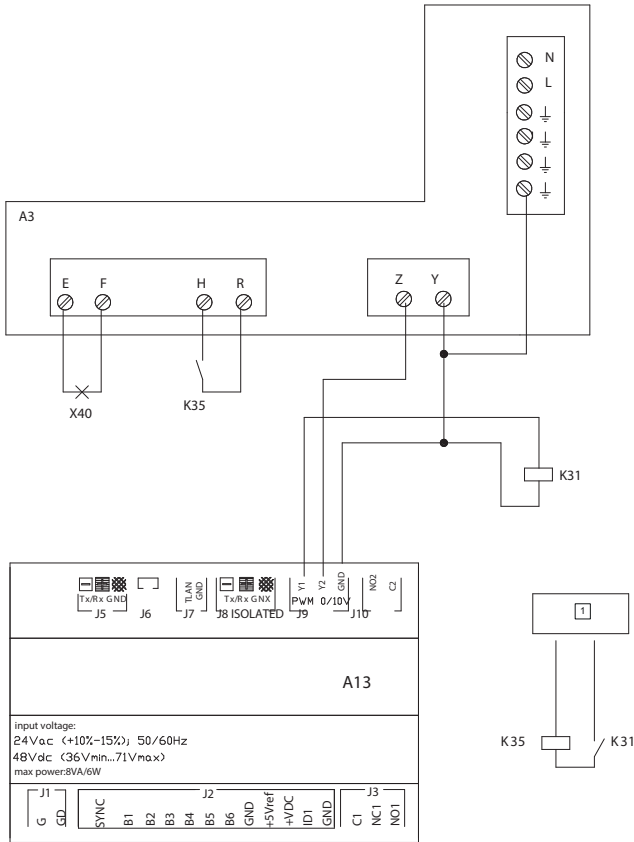

Key:

- A3 - Boiler P.C.B.
- A13 - Boiler manager
- X40 - Room thermostat jumper
- K31 - DHW thermostat relay (SSR 6 Vdc type)
- K35 - Support relay EMR 230 Vac 5A (not supplied). The relay must have a coil of at least 10mA or be equipped with a leakage current suppression system (Finder mod. 34.51.7.060.0010 type)
- 1 - 230/24 Vac 50 Hz power supply

- Notes:**
- Remove jumper X40
 - Set P29 = 17

9.15 SYSTEM MANAGER - CONNECTION TO BOILER THROUGH TA INPUT.

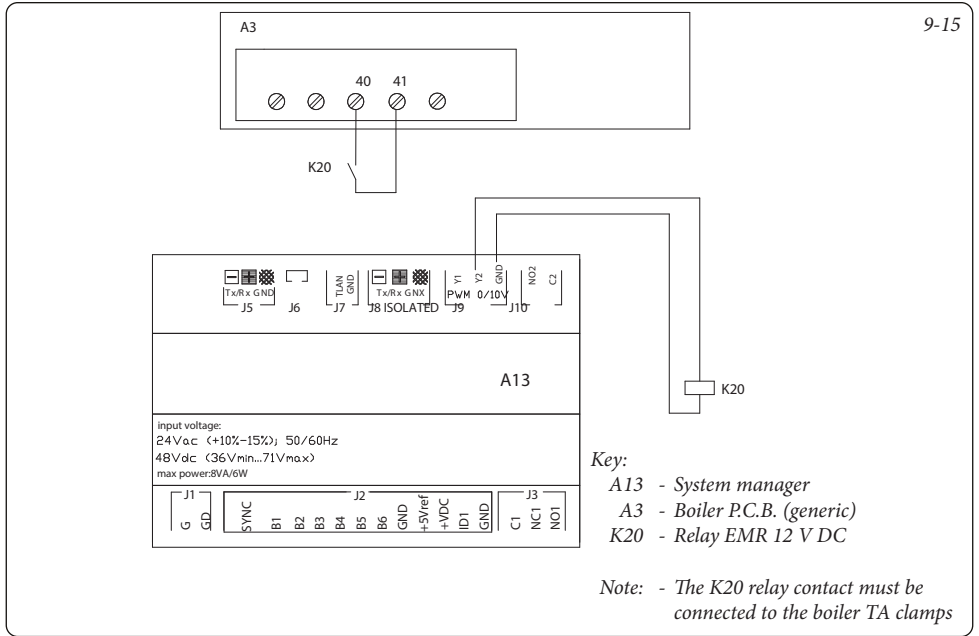

9.16 SYSTEM MANAGER - CONNECTION TO BOILER ALARM SIGNAL.

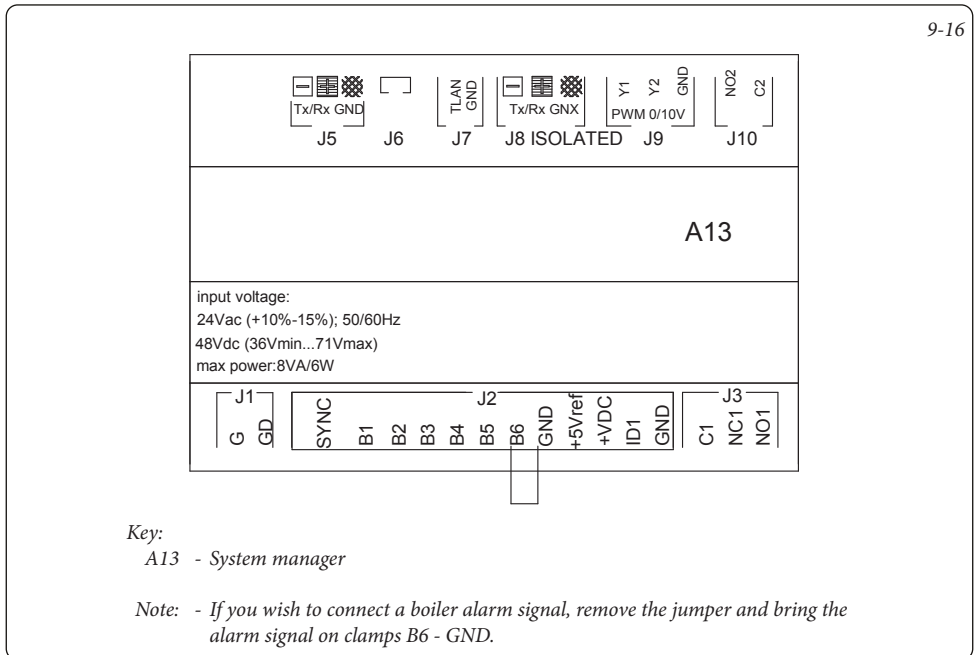

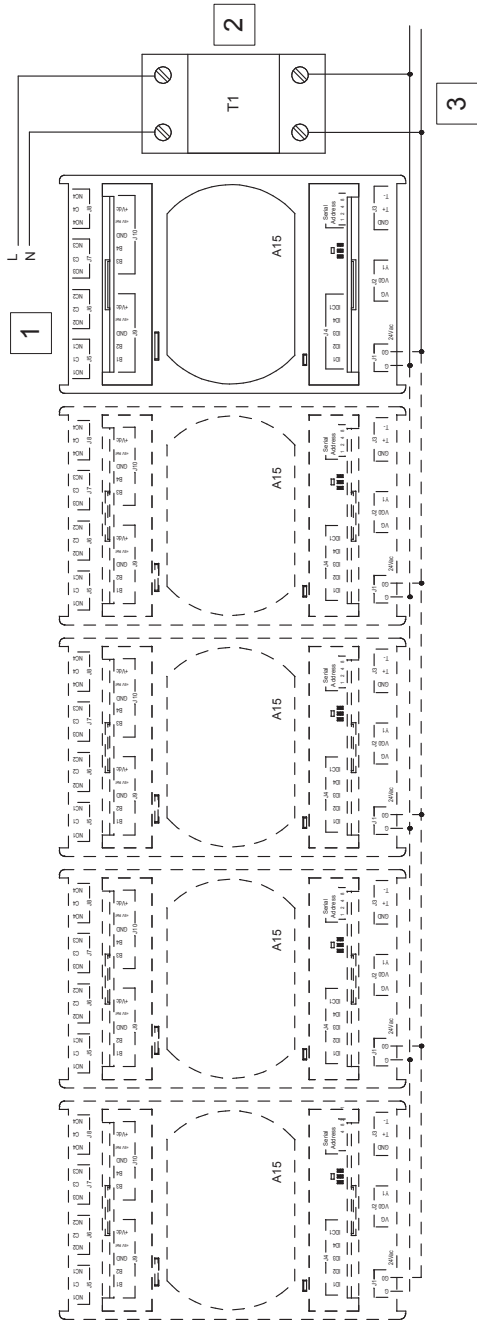

- Key:
- A15 - Zone expansion kit
 - T1 - 24 Vac transformer (not supplied with the System Manager)
 - 1 - Power supply 230 Vac - 50 Hz
 - 2 - Transformer 230 Vac - 24 Vac
 - 3 - Supply voltage 24Vac

Note: Max power absorbed by expansion only 6 W.

9.18 SYSTEM MANAGER - EXPANSION COMMUNICATION CABLE CONNECTION.

9-18

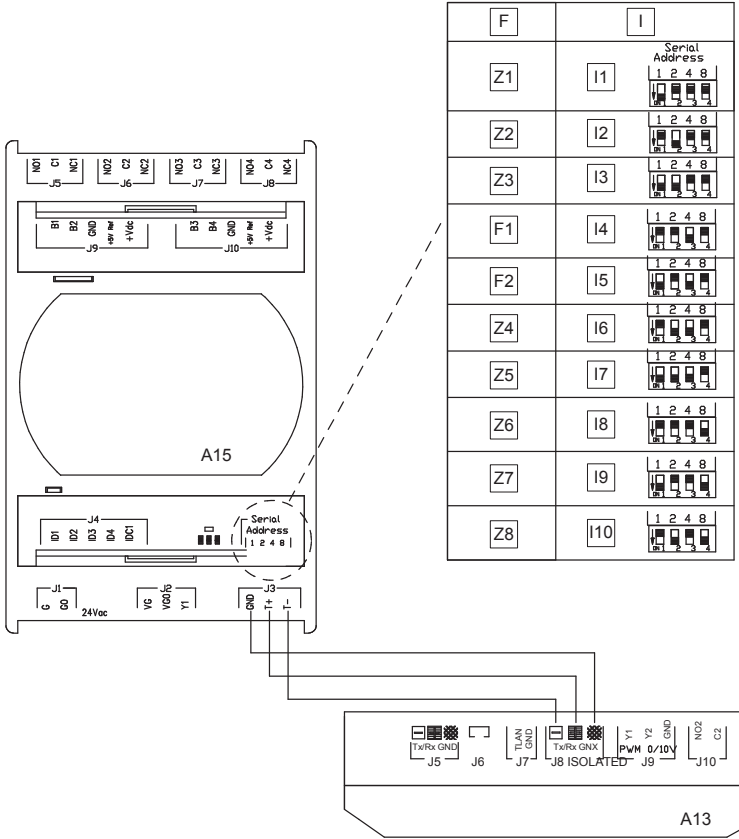

Key:

- | | | |
|--------------------------|--------------------------|------------------|
| A13 - System manager | F2 - Special functions 2 | I3 - Address 3 |
| A15 - Expansion | Z4 - Zone 4 | I4 - Address 4 |
| F - Function | Z5 - Zone 5 | I5 - Address 5 |
| I - Expansion Addresses | Z6 - Zone 6 | I6 - Address 6 |
| Z1 - Zone 1 | Z7 - Zone 7 | I7 - Address 7 |
| Z2 - Zone 2 | Z8 - Zone 8 | I8 - Address 8 |
| Z3 - Zone 3 | I1 - Address 1 | I9 - Address 9 |
| F1 - Special functions 1 | I2 - Address 2 | I10 - Address 10 |

- Note:
- Use shielded cable for RS485 line if installing the equipment in a household environment.
 - The maximum distances allowed between expansion and system manager depend on the type of cable and resistance as follows:
 - With telephone cable with resistance ≤ 0.14 (W/m) max distance 600 m;
 - With telephone cable with resistance ≤ 0.25 (W/m) max distance 400 m;
 - With shielded cable AWG24 with resistance ≤ 0.078 (W/m) max distance 600 m;

9.19 SYSTEM MANAGER - TA REQUEST CONNECTION WITH 1 FIXED ZONE.

9-19

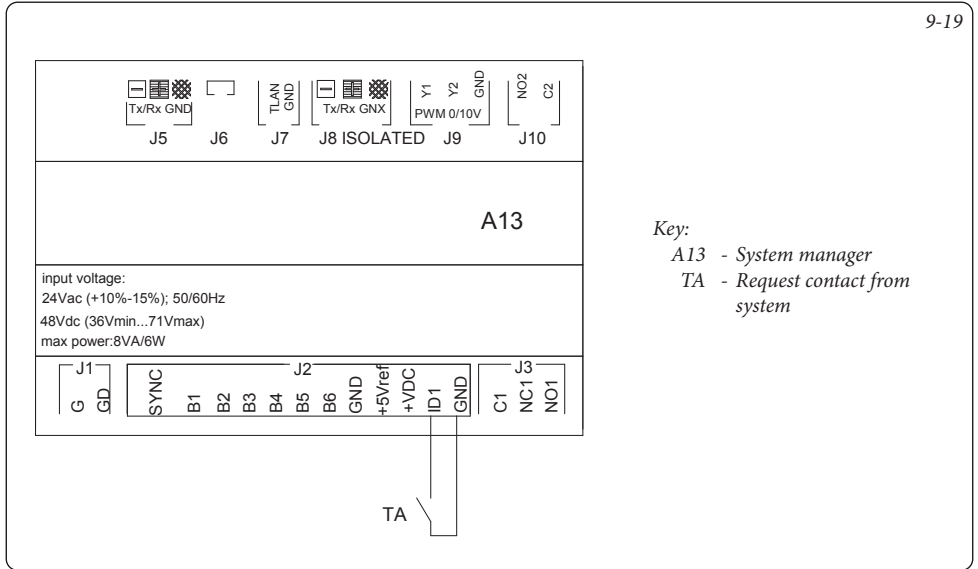

9.20 SYSTEM MANAGER - STORAGE TANK THREE-WAY CONNECTION.

9-20

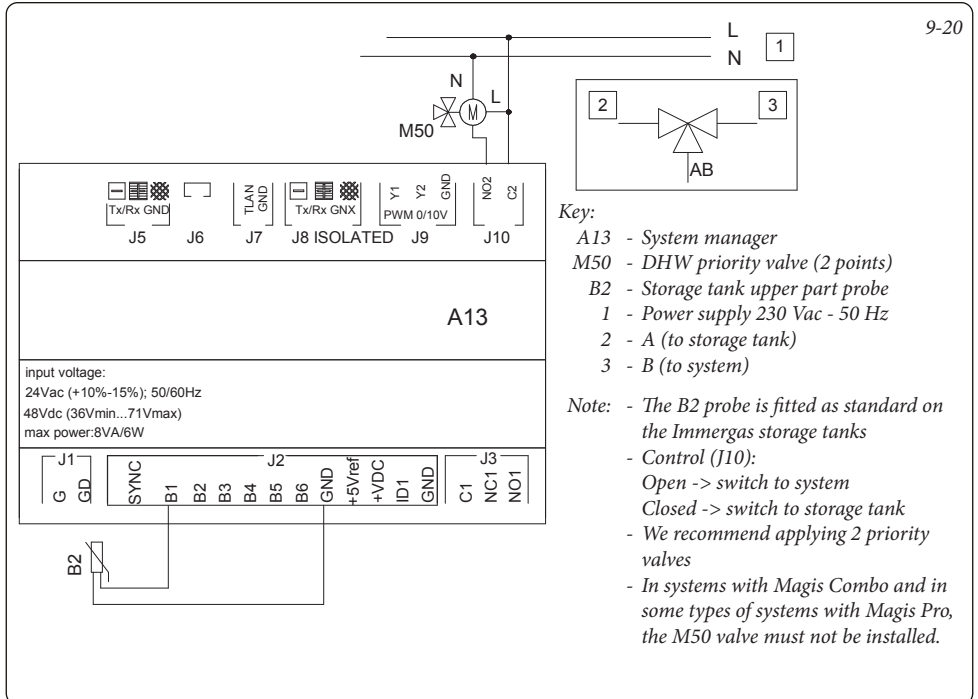

9.21 SYSTEM MANAGER - EXPANSION ZONE PUMP CONNECTION.

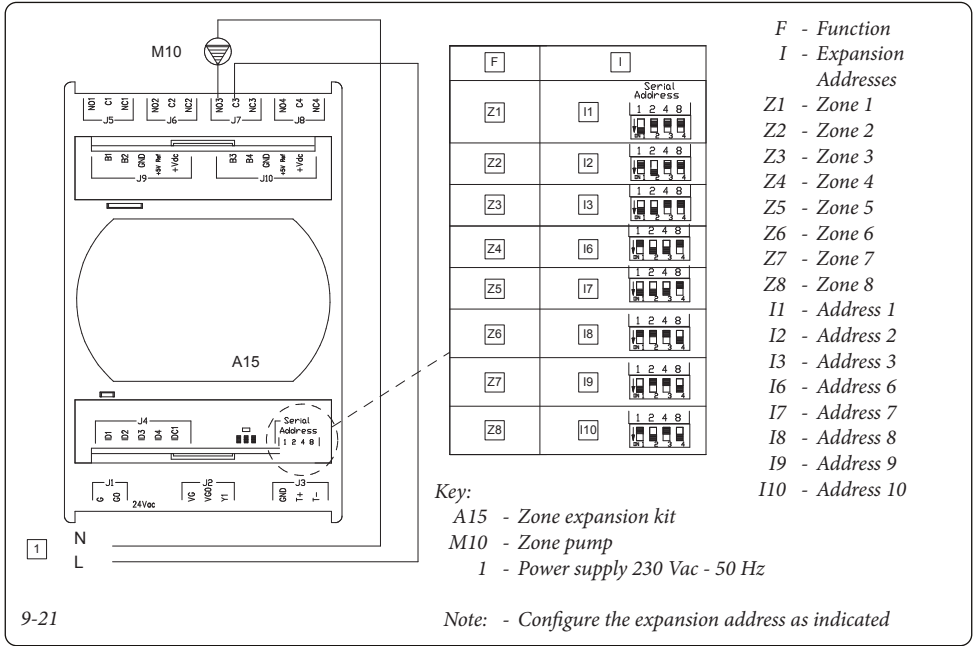

- F - Function
 I - Expansion Addresses
- Z1 - Zone 1
 - Z2 - Zone 2
 - Z3 - Zone 3
 - Z4 - Zone 4
 - Z5 - Zone 5
 - Z6 - Zone 6
 - Z7 - Zone 7
 - Z8 - Zone 8
 - I1 - Address 1
 - I2 - Address 2
 - I3 - Address 3
 - I6 - Address 6
 - I7 - Address 7
 - I8 - Address 8
 - I9 - Address 9
 - I10 - Address 10

9.22 SYSTEM MANAGER - EXPANSION ZONE FLOW PROBE CONNECTION.

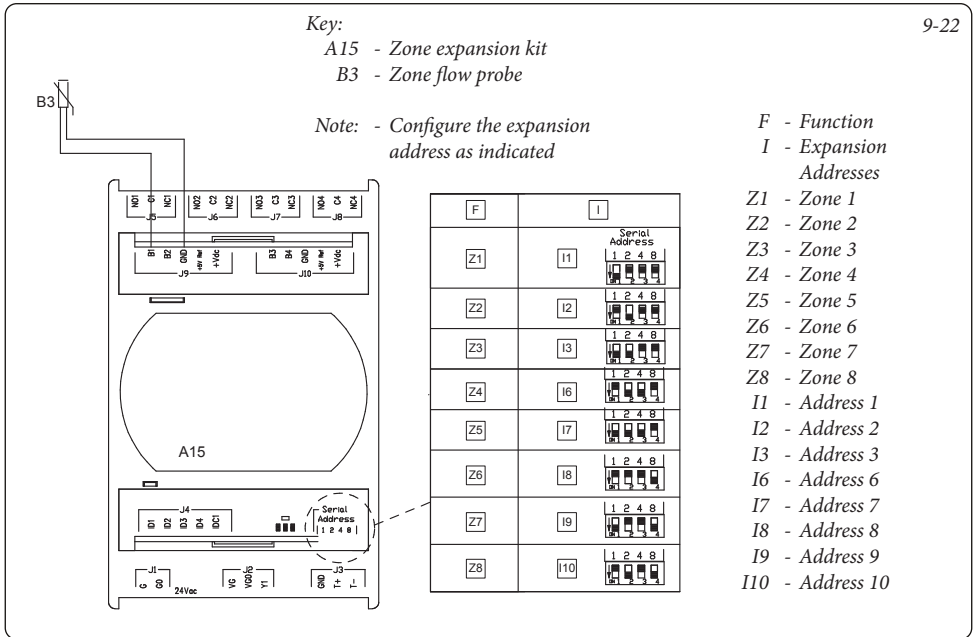

- F - Function
 I - Expansion Addresses
- Z1 - Zone 1
 - Z2 - Zone 2
 - Z3 - Zone 3
 - Z4 - Zone 4
 - Z5 - Zone 5
 - Z6 - Zone 6
 - Z7 - Zone 7
 - Z8 - Zone 8
 - I1 - Address 1
 - I2 - Address 2
 - I3 - Address 3
 - I6 - Address 6
 - I7 - Address 7
 - I8 - Address 8
 - I9 - Address 9
 - I10 - Address 10

9.23 SYSTEM MANAGER - EXPANSION ZONE MIXER CONNECTION.

9-23

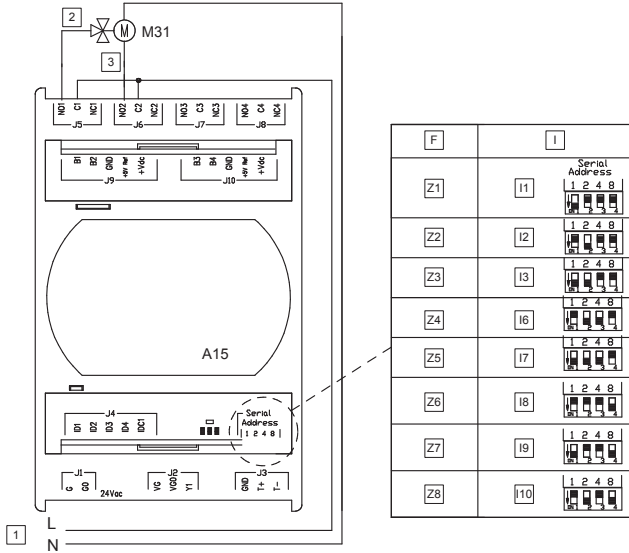

Key:

A15 - Zone expansion kit

M31 - Zone mixing valve

1 - Power supply 230 Vac - 50 Hz

2 - Open

3 - Closed

Note: - Configure the expansion address as indicated

F - Function

I - Expansion Addresses

Z1 - Zone 1

Z2 - Zone 2

Z3 - Zone 3

Z4 - Zone 4

Z5 - Zone 5

Z6 - Zone 6

Z7 - Zone 7

Z8 - Zone 8

I1 - Address 1

I2 - Address 2

I3 - Address 3

I6 - Address 6

I7 - Address 7

I8 - Address 8

I9 - Address 9

I10 - Address 10

9.24 SYSTEM MANAGER - CONNECTION TO ZONE ROOM THERMOSTATS.

9-24

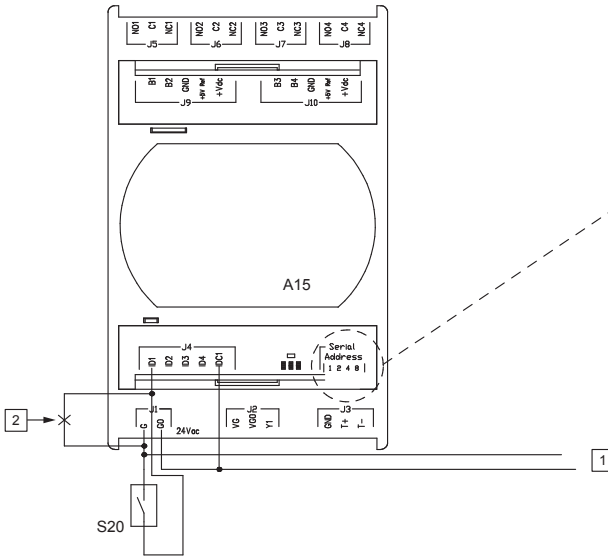

F	I	Serial Address
Z1	11	1 2 4 8
Z2	12	1 2 4 8
Z3	13	1 2 4 8
Z4	14	1 2 4 8
Z5	16	1 2 4 8
Z6	17	1 2 4 8
Z7	18	1 2 4 8
Z8	19	1 2 4 8
	I10	1 2 4 8

Key:

- A15: - zone expansion kit
- S20 - Zone room thermostat or potential-free contact to request
- 1 - Power supply 24Vac - 50Hz
- 2 - Remove any jumper ID1-G to connect TA
- F - Function
- I - Expansion Addresses
- Z1 - Zone 1
- Z2 - Zone 2
- Z3 - Zone 3
- Z4 - Zone 4
- Z5 - Zone 5
- Z6 - Zone 6
- Z7 - Zone 7
- Z8 - Zone 8
- I1 - Address 1
- I2 - Address 2
- I3 - Address 3
- I6 - Address 6
- I7 - Address 7
- I8 - Address 8
- I9 - Address 9
- I10 - Address 10

Note: - Configure the expansion address as indicated.

9.25 SYSTEM MANAGER - CONNECTION TO SAFETY THERMOSTAT.

9-25

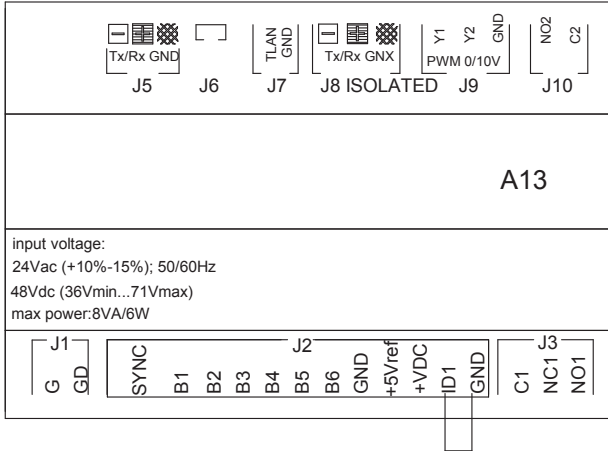

Key:

A13 - System manager

Note: - This connection is necessary in the presence of zone expansions with TA contacts / temperature-humidity probes/zone controls.

9.26 SYSTEM MANAGER - CONNECTION TO HUMIDISTAT.

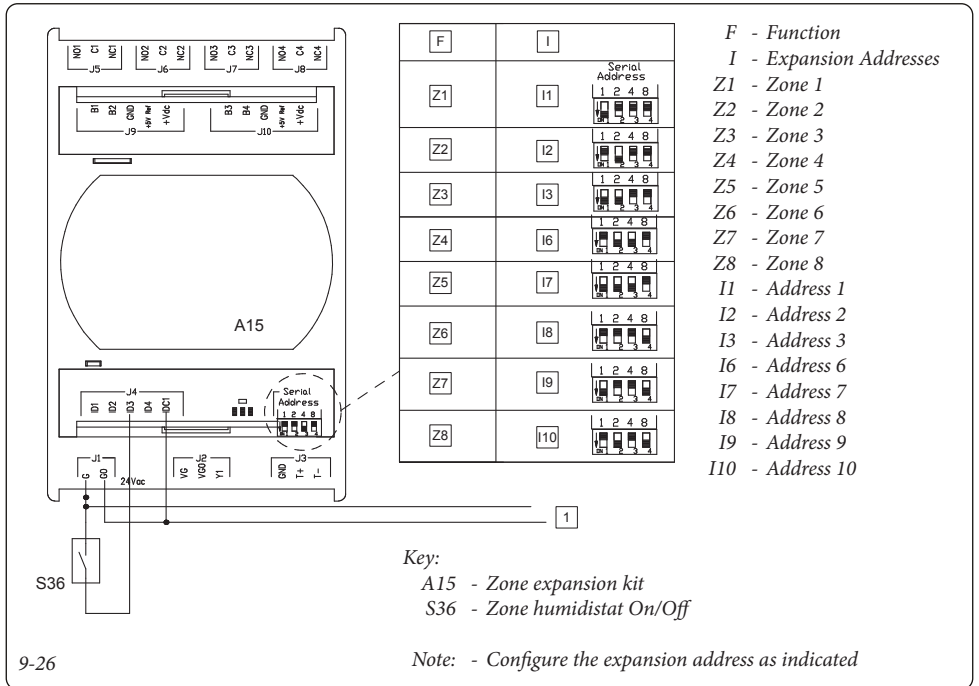

9-26

9.27 SYSTEM MANAGER - CONNECTION TO ZONE REMOTE PANELS.

9-27

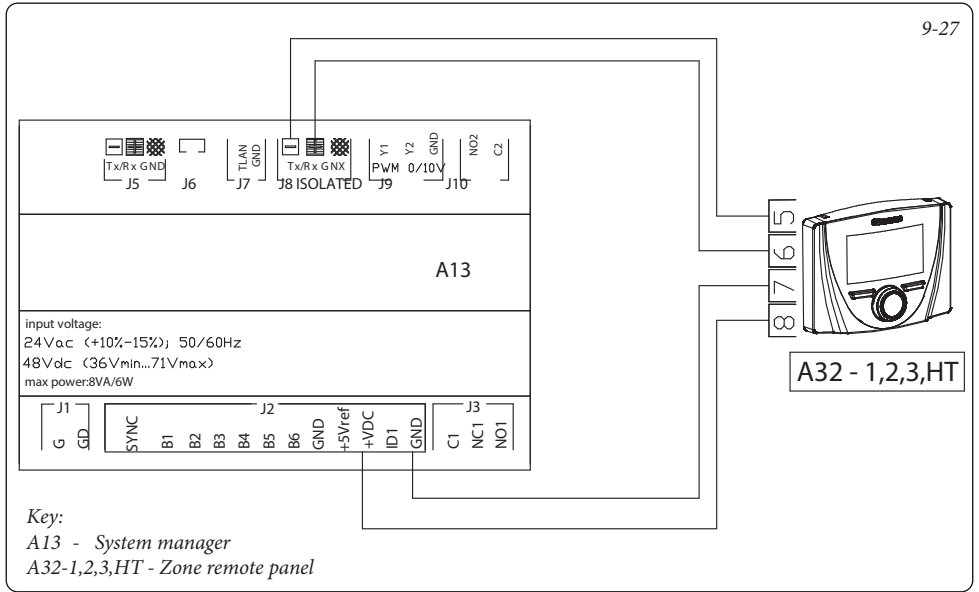

9.28 SYSTEM MANAGER - CONNECTION TO TEMPERATURE AND HUMIDITY PROBE.

9-28

Key:

- A15: - zone expansion kit
- A17: - room temperature humidity sensor kit

Note: - Configure the expansion address as indicated.

- For the electrical connections we recommend using 3-5 wire multipolar shielded cable with maximum section of 1.5 mm².

- In case of AT zone, only connect the temperature sensor

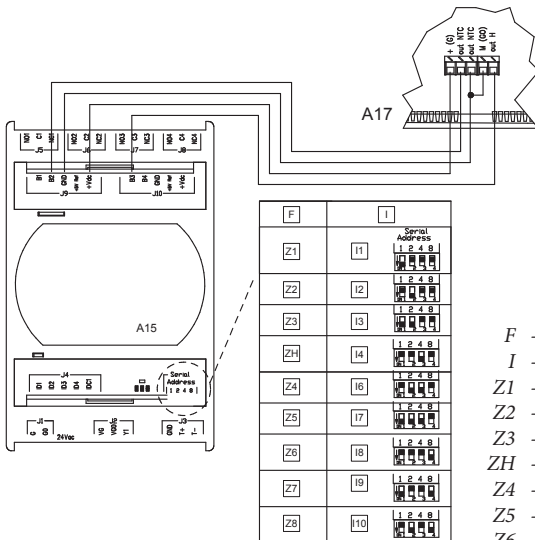

- F - Function
- I - Expansion Addresses
- Z1 - Zone 1
- Z2 - Zone 2
- Z3 - Zone 3
- ZH - Zone HT
- Z4 - Zone 4
- Z5 - Zone 5
- Z6 - Zone 6
- Z7 - Zone 7
- Z8 - Zone 8
- I1 - Address 1
- I2 - Address 2
- I3 - Address 3
- I4 - Address 4
- I6 - Address 6
- I7 - Address 7
- I8 - Address 8
- I9 - Address 9
- I10 - Address 10

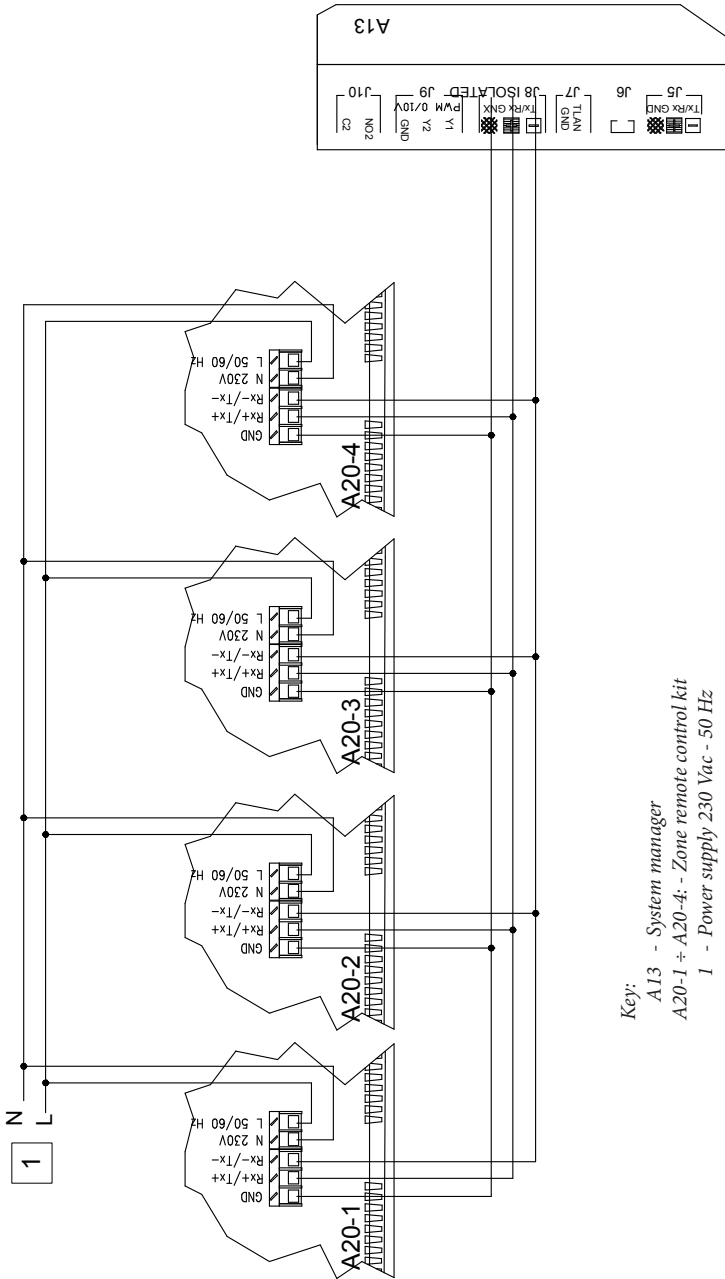

Key:

A13 - System manager

A20-1 ÷ A20-4: - Zone remote control kit

1 - Power supply 230 Vac - 50 Hz

Note: - Use shielded cable for RS485 line type AWG 20÷22, with overall network length not exceeding 500 m.

- Kit power supply: section of conductors: between 0.5 mm² and 1.5 mm².

- The devices can be associated to zones 1, 2, 3, HT.

9.31 SYSTEM MANAGER - HIGH-TEMPERATURE ZONE VALVES CONNECTION.

9-31

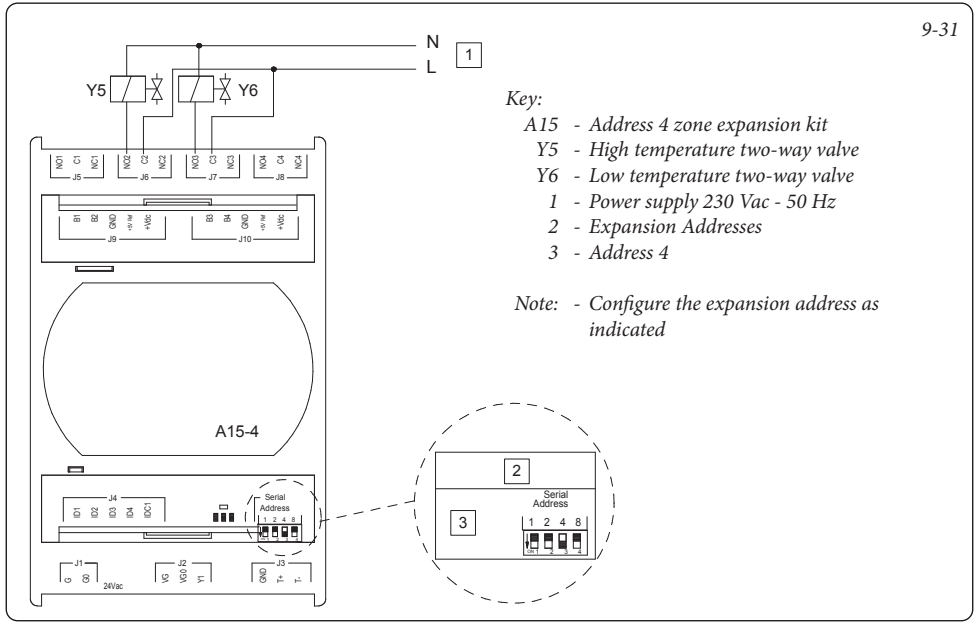

9.32 SYSTEM MANAGER - SUMMER/WINTER THREE-WAY CONNECTION.

9-32

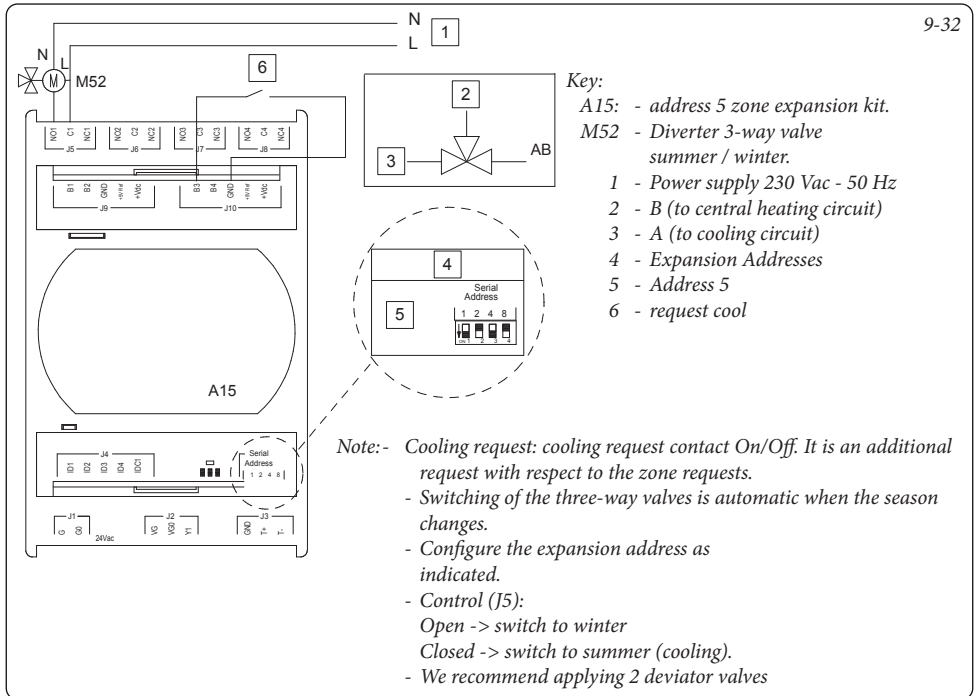

9.33 SYSTEM MANAGER - THERMAL DISCHARGE CONNECTION

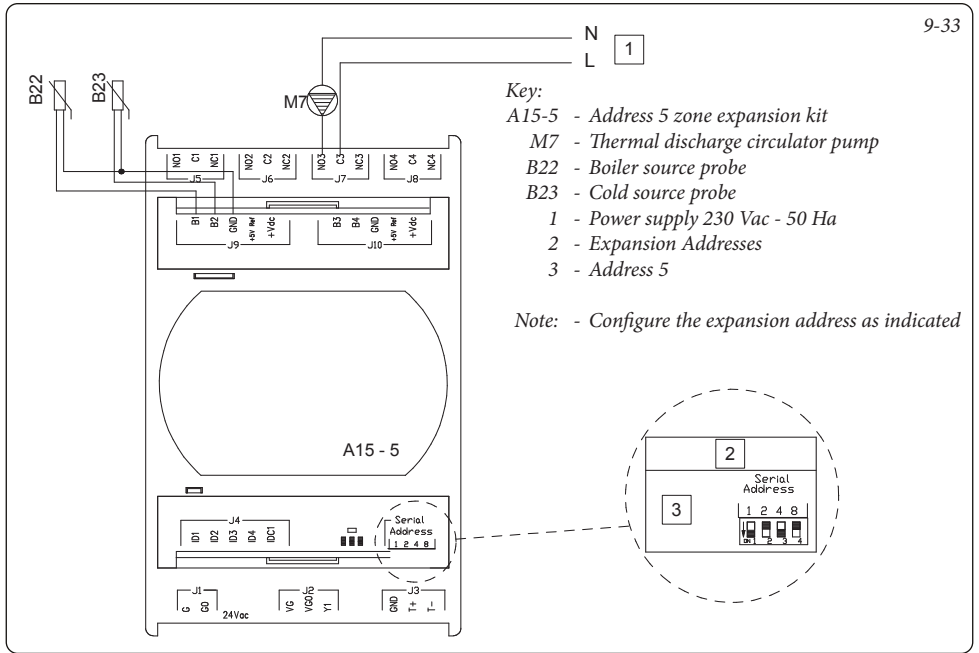

9.34 SYSTEM MANAGER - CONNECTION TO DHW RECIRCULATION.

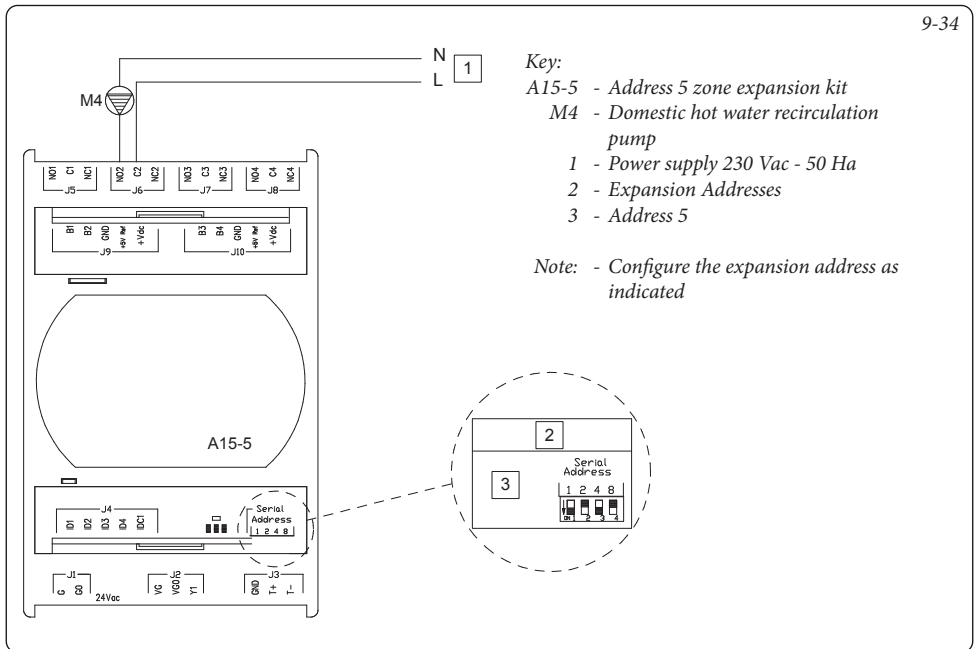

9.35 SYSTEM MANAGER - CONNECTION TO PHOTOVOLTAIC SYSTEM.

9-35

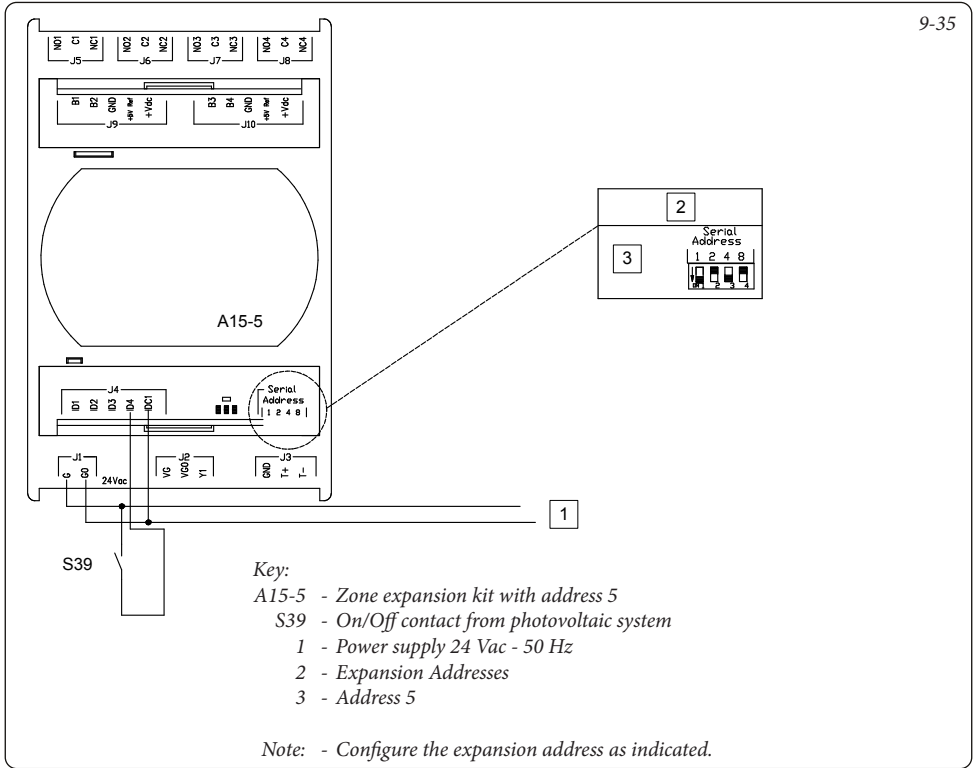

9.36 SYSTEM MANAGER - CONNECTION TO DOMINUS.

9-36

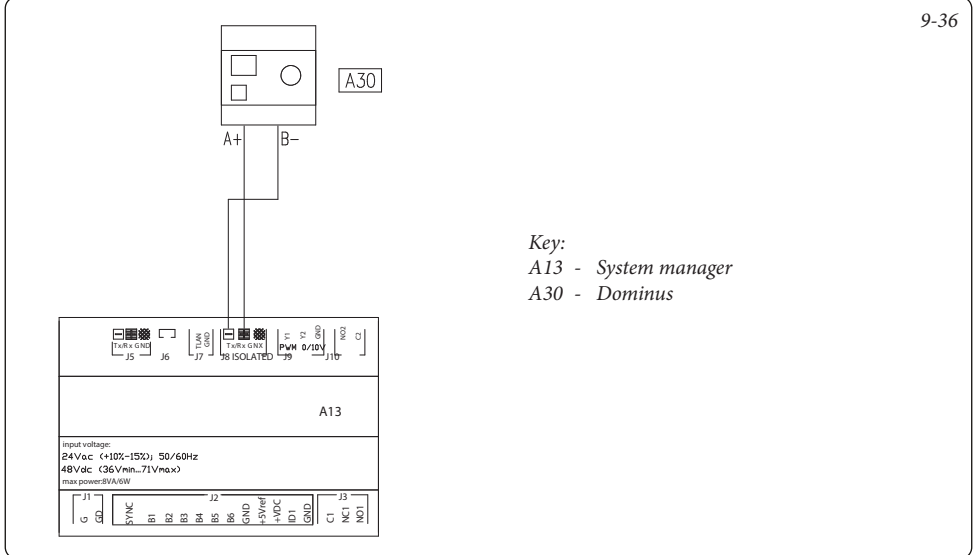

9.37 SYSTEM MANAGER - CONNECTION TO DOMOTICS WITH DIGITAL SIGNALS.

9-37

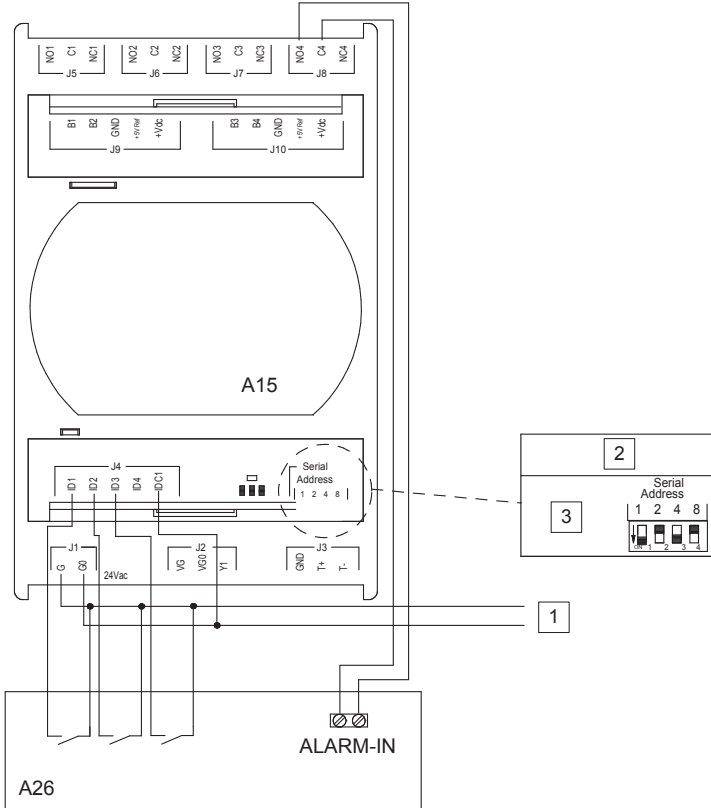

Key:

- A15 - Zone expansion kit with address 5
- A26 - Domotic system.
- 1 - Supply voltage 24 Vac - 50 Hz
- 2 - Expansion Addresses
- 3 - Address 5

Note: - Configure the expansion address as indicated.
 - Contact “domotics” management is executed using the following configurations:

Status	ID1	ID2	ID3
Stand-by	0	0	0
Winter	1	0	0
Summer	1	1	0
Cooling	0	0	1

9.38 SYSTEM MANAGER - CONNECTION TO DOMOTICS WITH COMMUNICATION PROTOCOL.

9-38

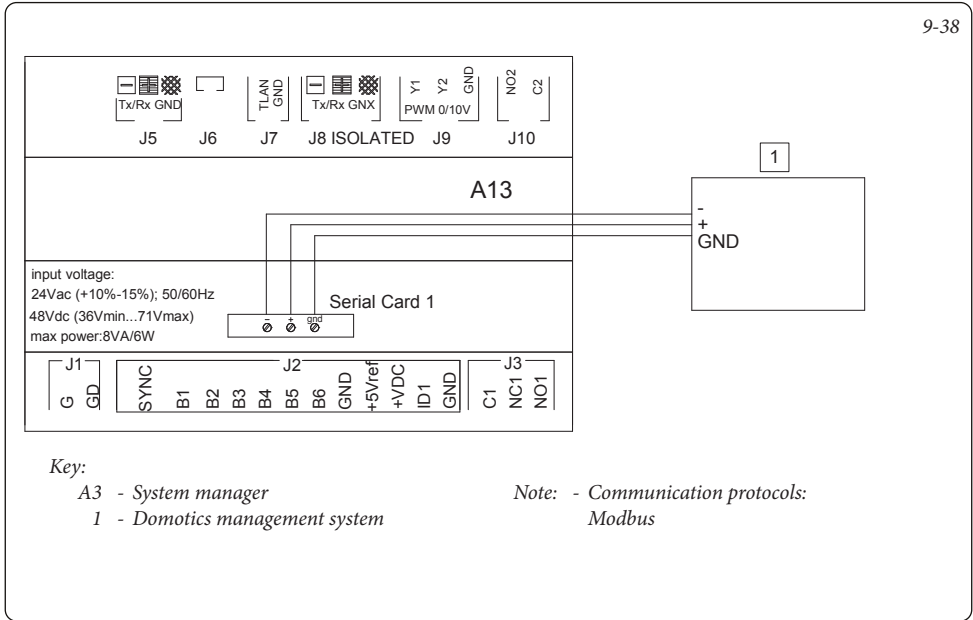

9.39 SYSTEM MANAGER - CONNECTION TO PHONE DIALLER.

9-39

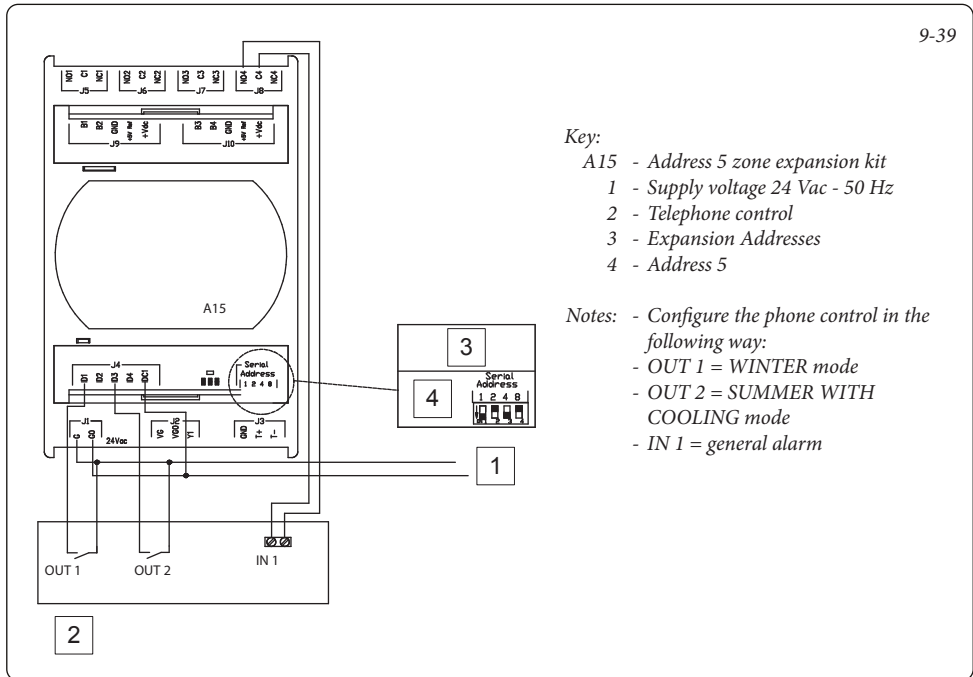

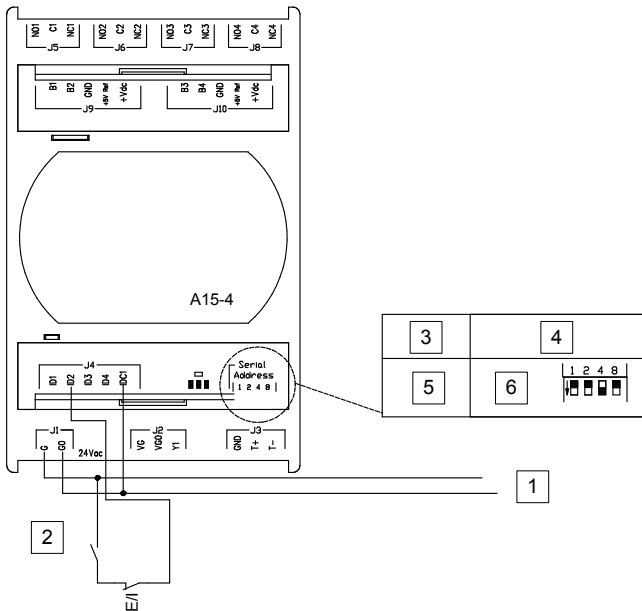

Key:

- A15-4: - Zone expansion kit with address 4
- 1 - Power supply 24 Vac - 50 Hz
- 2 - Fireplace heating system
- 3 - Function
- 4 - Expansion Addresses
- 5 - Special functions 1
- 6 - Address 4

THERMOFLUE: -On/Off contact from thermoflue.

E/I: - Manual switching to cooling switch

Note:- Configure the expansion address as indicated.

- Thermoflue: input contact to disable the generators when a thermoflue operates. If the contact closes HP, boiler/resistances remain in stand-by.
- The manual switching to cooling switch is a normally closed contact which, when I set the system to cooling, must be open to avoid inhibiting the activation of the HP in cooling and DHW.

9.41 SYSTEM MANAGER - PUFFER PROBE CONNECTION.

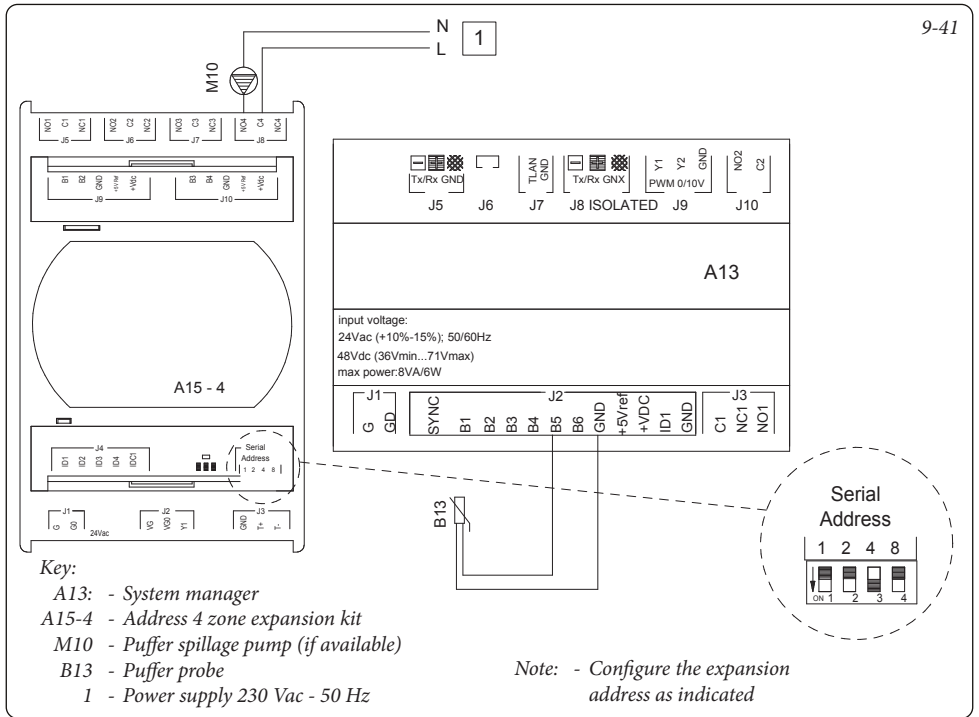

9.42 SYSTEM MANAGER - CENTRAL HEATING/COOLING THREE-WAY CONNECTION IN SYSTEMS WITH PUFFER.

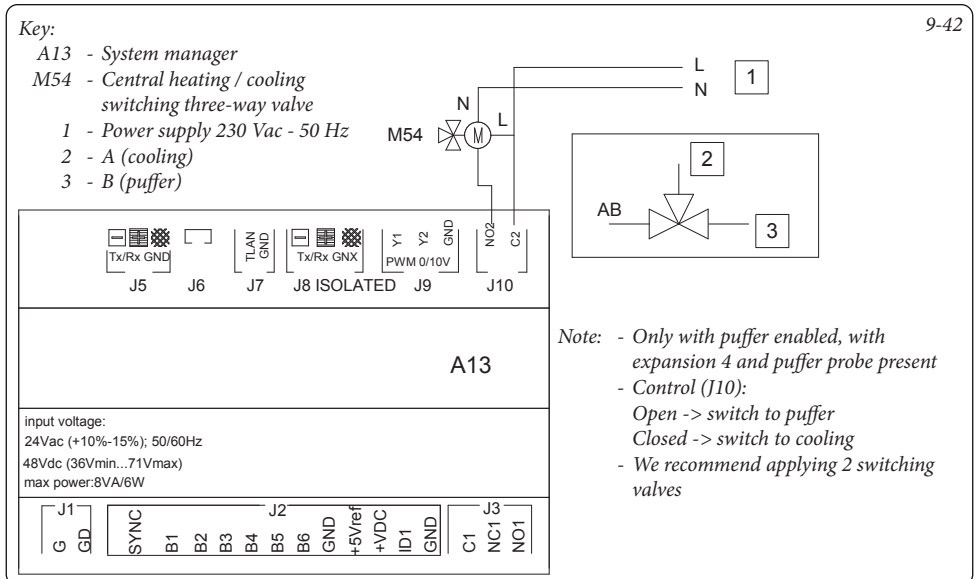

9.43 SYSTEM MANAGER - THREE-WAY CONNECTION INTEGRATION INTO SYSTEMS WITH PUFFER.

9-43

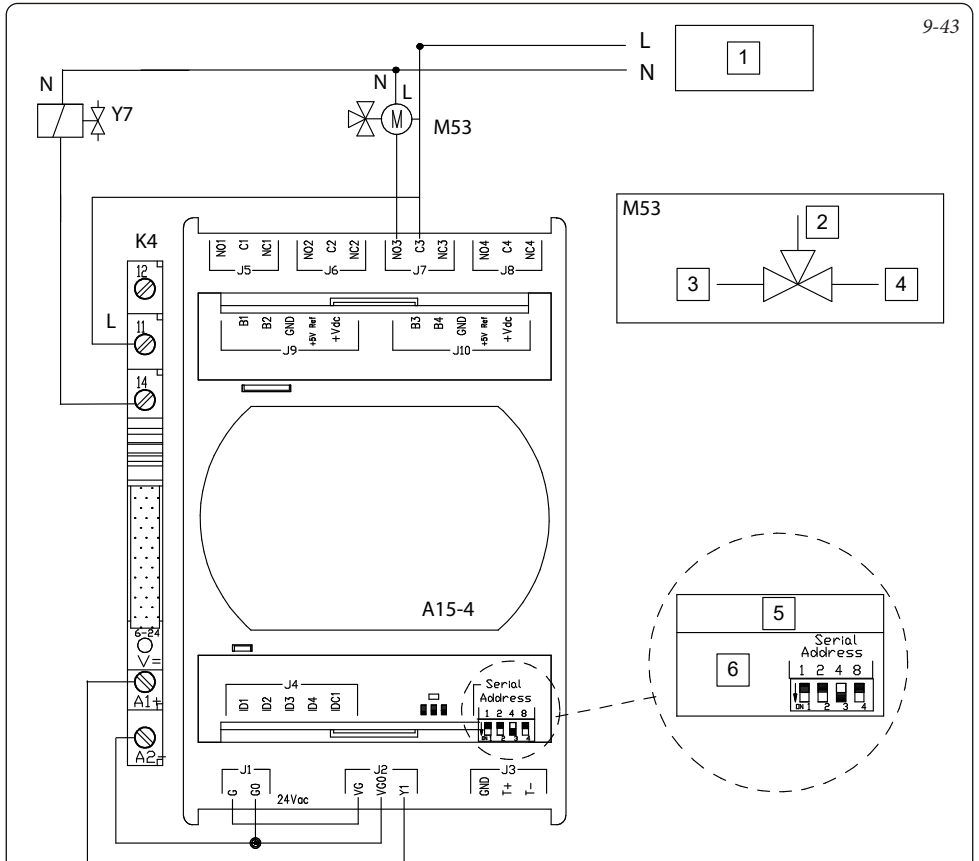

Key:

- 1 - Power supply 230 Vac - 50 Hz
- 2 - A (boiler)
- 3 - B (heat pump)
- 4 - AB (puffer)
- 5 - Expansion Addresses
- 6 - Addresses 4

A15-4: - zone expansion kit with address 4

K4: - Relay type EMR 12V DC

M53: - DHW integration three-way valve
The valve switches when the boiler activates for DHW integration, heating the upper part of the puffer.

Y7: - Low temperature two-way valve

- Command (J7)

Open -> switch to PdC

Closed -> switch to boiler

- We recommend applying 2 commutation valves

9.44 SYSTEM MANAGER - CONNECTION TO INERTIAL STORAGE TANK PROBE.

9-44

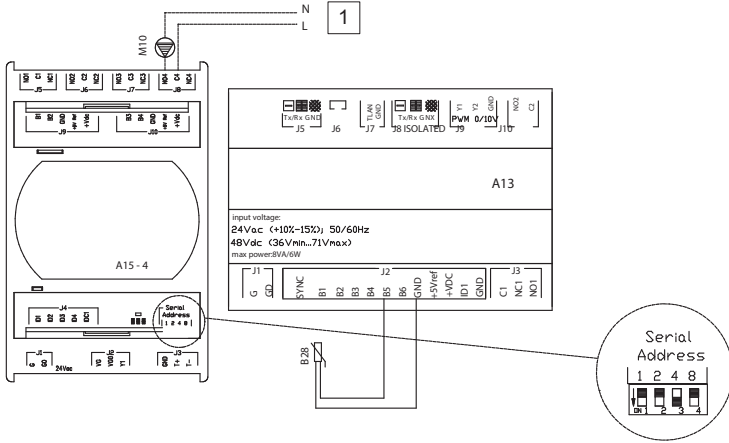

Key:

- A13 - System manager
- A15-4 - Address 4 zone expansion kit
- M10 - Bleeding circulator (optional)
- B28 - Inertial storage tank kit
- 1 - Power supply 230 Vac - 50 Hz

- Notes:
- Enable the expansion only when using the M10 circulator.
 - Configure the expansion address as indicated.

9.45 SYSTEM MANAGER - CONNECTION TO 1 SLOPING ROOF THERMAL SOLAR SYSTEM.

9-45

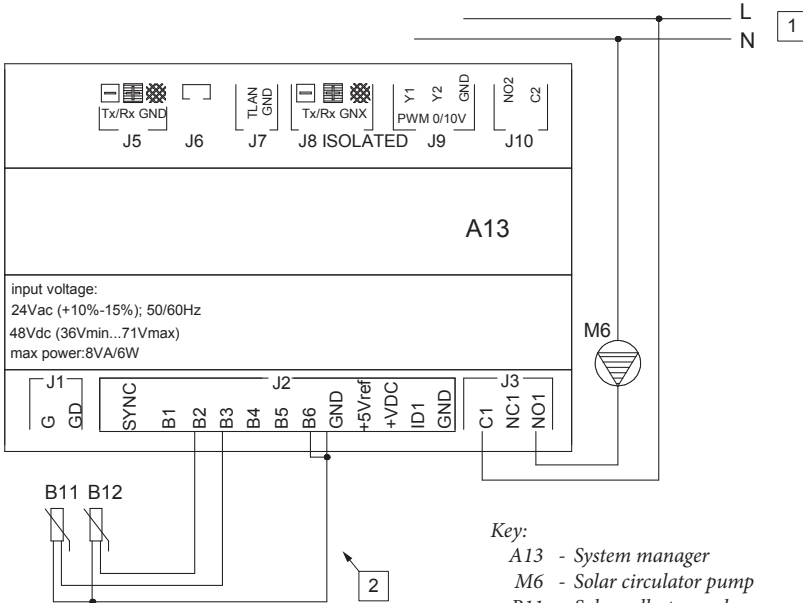

Key:

- A13 - System manager
- M6 - Solar circulator pump
- B11 - Solar collector probe
- B12 - Solar storage tank probe (low)
- 1 - Power supply 230 Vac - 50 Hz
- 2 - Input for generic boiler alarm

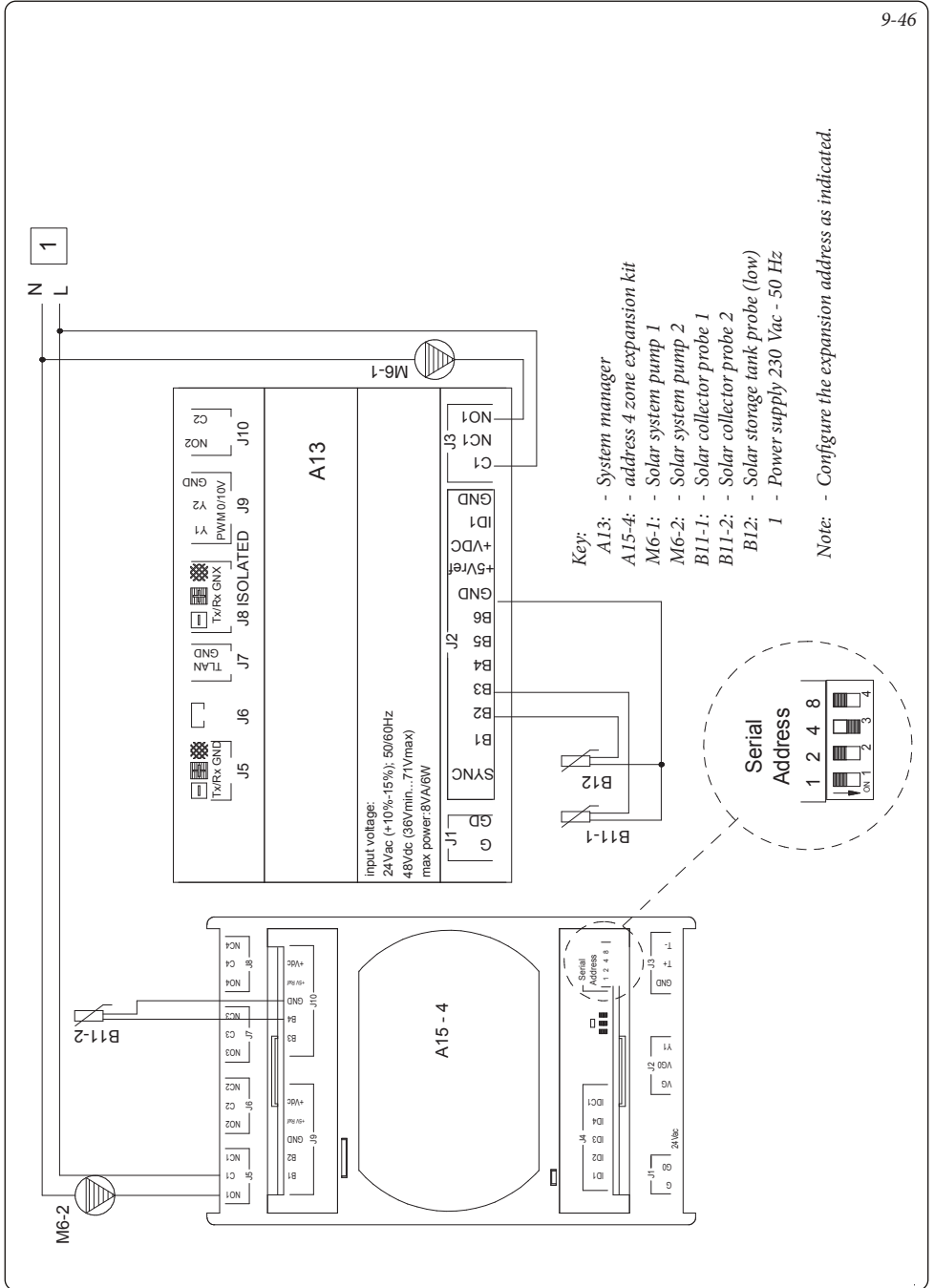

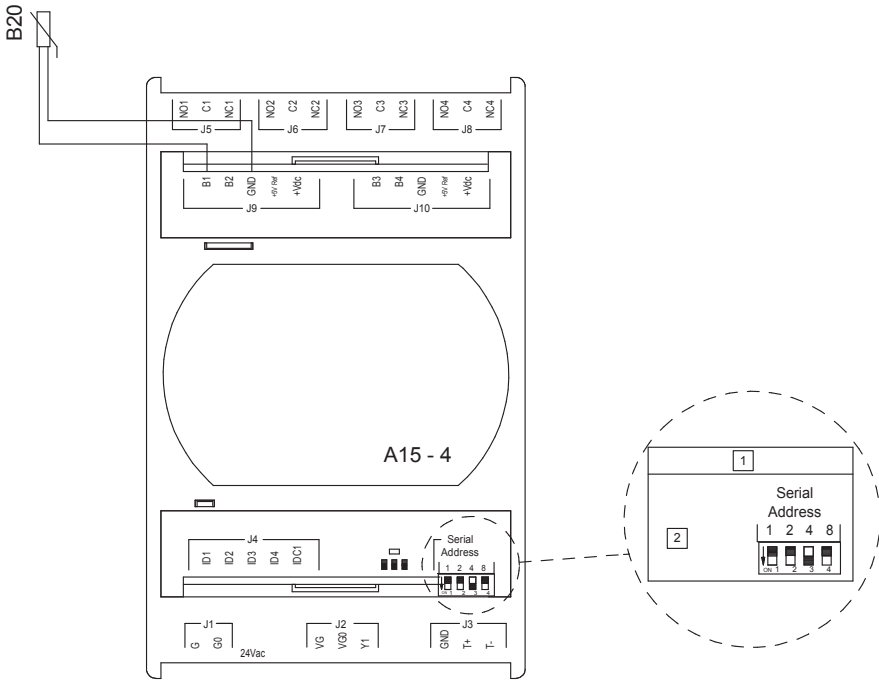

Key:

A15-4 - Address 4 zone expansion kit

B20 - Solar return probe

1 - Expansion Addresses

2 - Address 4

Note: - Configure the expansion address as indicated

9.48 SYSTEM MANAGER - CONNECTION TO EXTERNAL PROBE

9-48

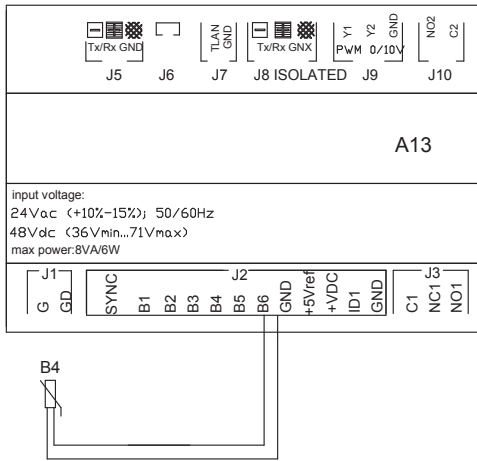

Key:
 A13 - System manager
 B4 - External probe

9.49 SYSTEM MANAGER - CONNECTION TO PLATE EXCHANGER DOWNSTREAM OF HEAT PUMP.

9-49

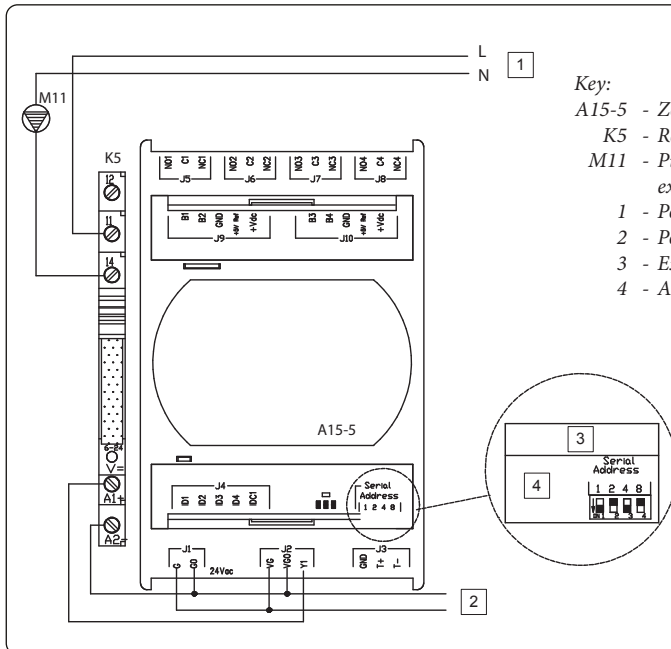

Key:
 A15-5 - Zone expansion kit with address 5
 K5 - Relay type EMR 12 V dc
 M11 - Pump downstream of the plate heat exchanger on heat pumps
 1 - Power supply 230 Vac - 50 Hz
 2 - Power supply 24 Vac - 50 Hz
 3 - Expansion Addresses
 4 - Address 5

10 LIST OF ANOMALIES.

Alarm Code	Alarm Description
A0012	Domestic hot water boiler/inlet probe anomaly
A0015	Configuration failed anomaly
A0032	Zone 2 Low Temperature probe anomaly
A0033	Zone 3 Low Temperature probe anomaly
A0036	IMG Bus communication loss
A0039	Solar collector probe anomaly
A0040	Solar cylinder probe anomaly
A0041	Solar collector high temperature alarm
A0042	Solar storage tank high temperature alarm
A0048	System flow probe anomaly
A0050	External probe anomaly
A0052	Storage tank probe anomaly for thermal discharge
A0053	Thermal discharge probe anomaly
A0054	Heating storage tank probe anomaly
A0055	Zone 1 temperature probe anomaly
A0056	Solar collector 2 probe anomaly
A0057	Solar return temperature probe anomaly
A0101	HP 1 off-line alarm
A0102	Expansion 1 off-line alarm
A0103	Expansion 2 off-line alarm
A0104	Expansion 3 off-line alarm
A0105	Expansion 4 off-line alarm
A0106	DHW probe alarm (DHW with double probe)
A0107	Boiler alarm
A0114	Incorrect configuration of digital Supervision inputs
A0115	Expansion 5 off-line alarm
A0116	HP 2 off-line alarm
A0117	HP 3 off-line alarm
A0118	HP 4 off-line alarm
A0119	Audax configuration alarm
A0120	Alarm set high for dehumidification Zone 1
A0121	Zone 1 device off-line alarm
A0122	Zone 2 device off-line alarm
A0123	Zone 3 device off-line alarm
A0124	HT Zone off-line device alarm
A0125	Zone 1 room temperature probe anomaly

A0126	Zone 2 room temperature probe anomaly
A0127	Zone 3 room temperature probe anomaly
A0128	HT Zone room temperature probe malfunction alarm
A0129	Zone 1 humidity probe anomaly
A0130	Zone 2 humidity probe anomaly
A0131	Zone 3 humidity probe anomaly
A0132	Alarm set high for dehumidification Zone 2
A0133	Zone 1 dehumidifier fault alarm
A0134	Zone 2 dehumidifier fault alarm
A0135	Zone 3 dehumidifier fault alarm
A0136	Alarm set high for dehumidification Zone 3
A0137	Reset system alarm - Restart the system
A0138	Screed heater alarm in progress
A0139	De-aeration alarm in progress
A0140	Inertial storage tank probe alarm
A0142	Dominus Offline alarm
A0177	DHW maximum time alarm
A0178	Anti-Legionella cycle not successful
A0204	Zone 6 off-line expansion alarm
A0205	Zone 7 off-line expansion alarm
A0206	Zone 8 off-line expansion alarm
A0207	Zone 9 off-line expansion alarm
A0208	Zone 10 off-line expansion alarm
A0214	Zone 4 room temperature probe anomaly
A0215	Zone 5 room temperature probe anomaly
A0216	Zone 6 room temperature probe anomaly
A0217	Zone 7 room temperature probe anomaly
A0218	Zone 8 room temperature probe anomaly
A0224	Zone 4 humidity probe anomaly
A0225	Zone 5 humidity probe anomaly
A0226	Zone 6 humidity probe anomaly
A0227	Zone 7 humidity probe anomaly
A0228	Zone 8 humidity probe anomaly
A0234	Zone 4 dehumidifier fault alarm
A0235	Zone 5 dehumidifier fault alarm
A0236	Zone 6 dehumidifier fault alarm
A0237	Zone 7 dehumidifier fault alarm
A0238	Zone 8 dehumidifier fault alarm
A0244	Zone 4 probe anomaly
A0245	Zone 5 probe anomaly
A0246	Zone 6 probe anomaly
A0247	Zone 7 probe anomaly
A0248	Zone 8 probe anomaly

The heat pump reports an anomaly by means of a structured code as follows: "Anxxx", where "n" indicates the heat pump number and "xxx" indicates the fault code. "A9xxx" is a boiler error (please refer to the relevant instruction manual).

The occurrence of anomaly An005 relating to a Magis M heat pump indicates the absence or failure of the Magis M coupling resistor to hybrid systems.

11 PRODUCT SPECIFICATIONS

In accordance with Regulation 811/2013 the temperature control device class is:

Class	Contribution to the environmental heating seasonal energy efficiency	Description
VI	+4 %	System manager kit
VIII	+5 %	System manager kit combined with 3 devices (zone remote panel, zone remote control, humidity temperature sensor)



This instruction booklet
is made of ecological paper



immergas.com

Immergas S.p.A.
42041 Brescello (RE) - Italy
Tel. 0522.689011
Fax 0522.680617

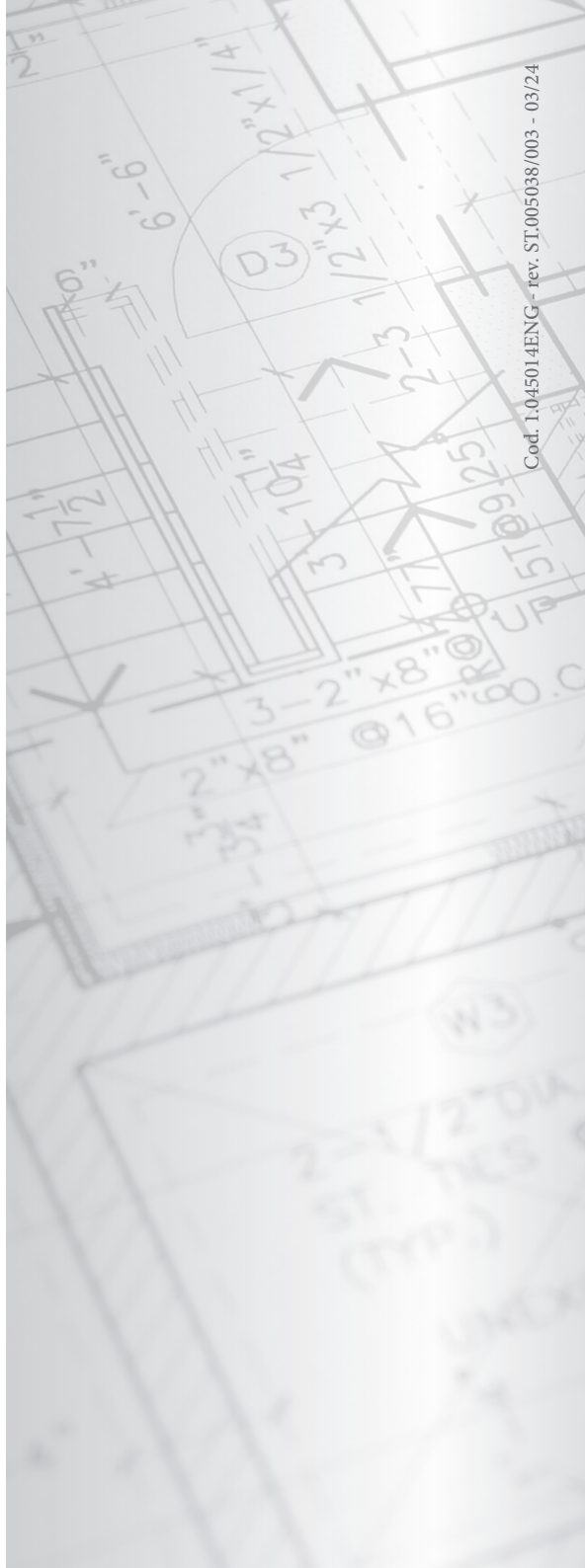

Cod. I-045014ENG - rev. ST.005038/003 - 03/24