



CAR^{V2}

Modulating remote
control

IE

**Instructions and
warning book**



Dear Client,

*Our compliments for having chosen a top-quality **Immergas** product, able to assure well-being and safety for a long period of time.*

*As an **Immergas customer** you can also count on a qualified after-sales service, prepared and updated to guarantee constant efficiency of your "Remote Control".*

*We would like to supply you with some important indications, the respect of which will confirm your satisfaction with the **Immergas** product:*

- Read the following pages carefully: you will obtain useful suggestions regarding the correct use of the appliance.*
- For any interventions or routine maintenance contact "**Authorised After-Sales centres**": they have original spare parts and specific preparation.*

INDEX Page

How to use the instruction book.....	4
Foreword.....	4
General recommendations.....	4
Case cleaning.....	5
1. Installation.....	6
1.1 Installation recommendations.....	6
1.2 Installation operations.....	6
2. Description of Controls.....	10
3. Description of display.....	11
3.1 Back-lighting (function available in the pre-set models).....	12
4. Start-up.....	13
4.1 Programming current day and time.....	13
4.2 Selection of functioning mode.....	13
5. Summer mode functions.....	16
5.1 DHW temperature setting.....	16
5.2 DHW timer (for storage tank unit).....	16
6. Winter mode functions.....	17
6.1 Manual functioning.....	17
6.2 Automatic functioning.....	18
6.3 Forced automatic functioning.....	18
6.4 Boiler flow temperature.....	19
6.5 Room anti-freeze function.....	19
6.6 Functioning in winter mode with external temperature probe.....	19
7. Cooling mode functions.....	20
7.1 Manual functioning.....	20
7.2 Automatic functioning.....	21
7.3 Forced automatic functioning.....	21
7.4 Flow temperature.....	22
8. Information.....	23
9. Programming CAR ^{v2} remote control.....	24
9.1 Setting comfort and economy room temperature.....	24
9.2 Programming functioning time.....	25
10. Diagnostics and errors.....	27
10.1 Diagnostics.....	27
10.2 Reset errors.....	27
10.3 Reset CAR ^{v2} remote control.....	27
11. Special functions.....	28
11.1 LANG (language selection).....	28
11.2 REGULT (Management of regulation parameter).....	28
11.3 HOLIDAY (holiday program).....	29
11.4 LEGION (anti-legionella function).....	30
11.5 REMOTE (telephone control).....	30
11.6 CODE.....	30
12. Functions protected by code (CODE).....	31
12.1 AMB (room probe - On / Off or modulating functioning mode).....	31
12.2 REDUCT (functioning in reduced mode).....	31
12.3 FRO PR (anti-freeze level).....	32
12.4 ZONE (function not present on this model).....	32
12.5 SERVIC (programmed maintenance).....	32
13. Disabling the chrono-thermostat.....	32
14. Replace the batteries.....	32
15. Disposal of the product at end of life.....	32
16. TECHNICAL FEATURES.....	33
16.1 Product sheet.....	34
17. Factory setting.....	35

HOW TO USE THE INSTRUCTION BOOK.

The instruction book has been divided into 3 main parts:
in the first, for the installer, the assembly and connection phases of the remote control with the boiler are described;
in the second, all functioning program customisation phases are described;
in the third and last part, all operations for displaying and keeping system functioning under control are described.

FOREWORD.

The “**Immergas**” **CAR** ^{V2} modulating remote control has been designed to guarantee ideal temperature conditions at any time of the day and night for each individual day of the week. Only a few minutes are required for installation: it is connected to the boiler by just 2 cables, through which, it receives and sends the adjustment and control commands and receives the power supply. On completion of installation it is ready to function thanks to the pre-set program inside. The customer can modify the basic program according to requirements. Programming of the “**CAR** ^{V2}” remote control is extremely easy and a wide display allows constant control of all values set.

GENERAL RECOMMENDATIONS.

This manual has been drawn-up for: **the Installer** and **the User**.

- Carefully read the warnings contained in this document as they are required to indicate the use of the **CAR** ^{V2} remote control envisioned by the design hypothesis, the technical features, the installation, assembly, programming, adjustment and use instructions.
- The system must be in compliance with the Standards in force.
- The instruction manual must be considered a part of the **CAR** ^{V2} remote control and must be “**kept for future reference**”.
- After having removed the packaging, check the integrity of the **CAR** ^{V2} remote control. If in doubt, do not use it and contact the **Dealer or Manufacturer**.
- The **CAR** ^{V2} remote control is destined only for the use for which it has been expressly designed. Any other use must be considered improper and therefore dangerous.
- Our products are realised in compliance with the Safety Standards in force, it is therefore recommended to use all those devices or attentions in a way that injury/damage is not caused to persons or objects.

- Do not remove parts of the CAR ^{V2} remote control when it is functioning.
- Do not use the CAR ^{V2} remote control exposed to heat sources or under the scorching sun.
- Periodically check the battery charge.
- The manufacture is relieved from any liability in the following cases:
 - a) Incorrect installation.
 - b) Boiler functioning defects to which the Remote Control is applied.
 - c) Unauthorised modifications or interventions.
 - d) Total or partial failure to comply with instructions.
 - e) Exceptional events etc.

CASE CLEANING.

To clean the case of CAR ^{V2} remote control use damp cloths. Never use abrasive or powder detergents.

WARNING

Immergas reserves the right to make improvements and modifications to details and accessories, excepting the essential features of the model described and illustrated herein.

1. INSTALLATION.

1.1 Installation recommendations.

The CAR^{V2} remote control, including the relative cables and connections to the boiler, must be installed by specialised staff. On the initial check of the boiler, when the CAR^{V2} remote control is inserted into the system, the authorised after-sales centre checks the connection to the generator terminal board and adjusts functioning.

Important: laying of the CAR^{V2} remote control cables is excluded from the boiler checks; it is the responsibility of the installer company.

1.2 Installation operations.

1) Separate the fixing template from the body of the CAR^{V2} remote control using a screwdriver as a lever in the relevant recess (Fig. 3). Install the CAR^{V2} remote control away from heat sources and in a suitable position to detect the room temperature correctly (Fig. 1 and 2).

Note: the presence on the rear of the remote control of the pipe for electric connection cables with the boiler could recall air from outside the establishment and interfere with the correct detection of the room temperature (e.g.: boiler installed outside and use of the suction hood in the kitchen). Have the job carried out by qualified staff.

2) Install the CAR^{V2} remote control using the holes made in the rear of the same directly onto the wall (Fig. 4) or on a recess box (Fig. 5) using the relative supplied screws.

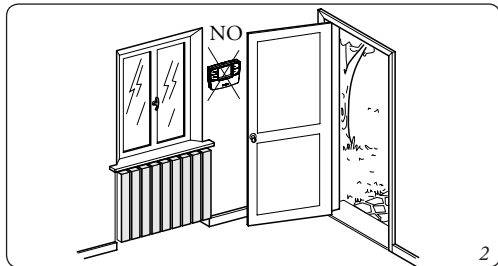
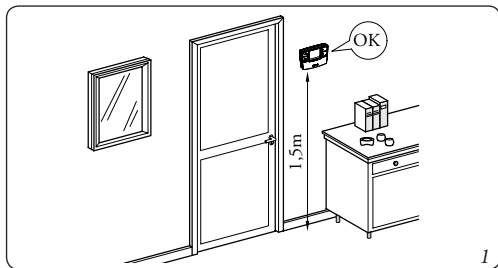

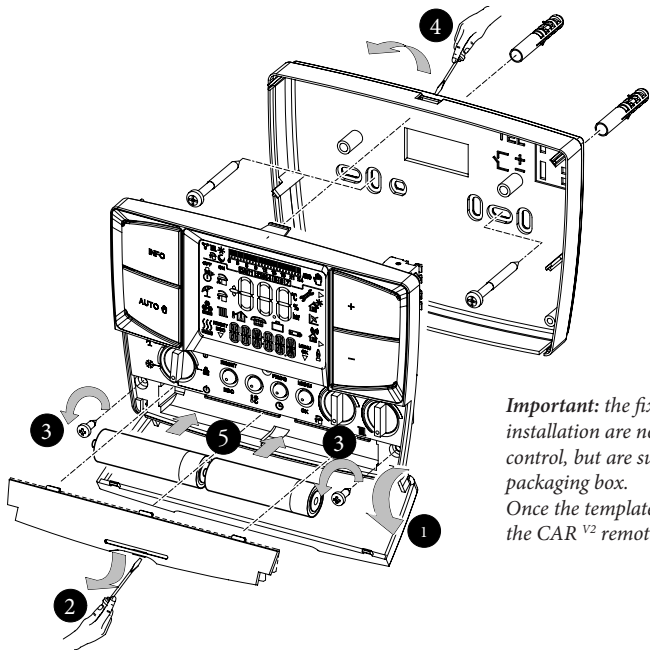

Important: the fixing screws (action n° 3) on first installation are no present on the CAR V2 remote control, but are supplied in a bag present in the packaging box.

Once the template is fixed to the wall, fix the body of the CAR V2 remote control using the 2 screws.

- 3) To make the electrical connections (Fig. 4) do not operate when the boiler is live. The connection must be made respecting the polarity of the conductors (+ and -), connecting the CAR V2 to the boiler clamps envisioned at communication with the CAR or, if not present, to the clamps envisioned for the CRD.

Connect the CAR V² remote control to the boiler clamps envisioned at communication with the CAR remote control or, if not present, to the clamps envisioned for the CRD.

Note: refer to the electrical connections stated in the boiler instruction book.

The connection to the boiler is made using two wires (Fig. 5) with minimum section of 0.50 mm² and maximum of 1.5 mm² and with maximum length of 50 metres.

N.B: for correct installation prepare a dedicated line for the connection of the CAR V² remote control according to the Standards in force regarding electrical systems. If this is not possible interference due to other electric cables could cause malfunctioning of the CAR V² remote control itself.

- 4) Fix the body of the CAR V² remote control to the support template, engaging it with pressure and using the two screws provided (Fig. 3).
- 5) Insert 2 1.5 V AA batteries (not supplied) into the pre-set housing (Fig. 3) and close the battery compartment.
- 6) After the boiler has been powered, wait about 30 seconds before regulation in a way that the communication between CAR V² remote control and boiler has established.

4

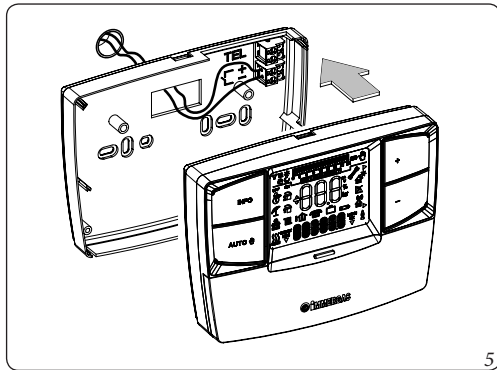
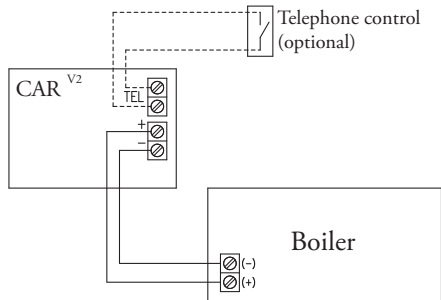



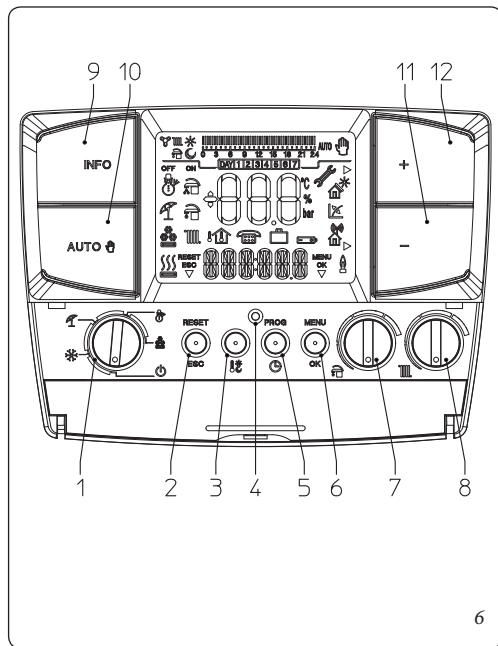





2. DESCRIPTION OF CONTROLS.



















Ref.	Description
1	Main selector: Off, Stand-by/anti-freeze, Summer, Winter, Cooling
2	“Reset” boiler anomalies/“Esc” escape parameter or return to previous menu button (programming mode)
3	Comfort and economy room temperature setting button
4	Reset button for starting CAR ^{V2} remote control in event of anomaly of the same.
5	Access button to time, day and timer
6	Access button to the programming/confirm parameters menu
7	Domestic hot water temperature selector switch
8	- Central heating temperature selector (without external temperature probe) - “OTC” value selector (with external temperature probe) (*)
9	Information buttons
10	Manual, automatic functioning button
11	Temperature decrease button
12	Temperature increase button

(*) The “OTC” value shown on the display coincides with the selected curve (see Fig. 23) for calculating the maximum central heating set point.

3. DESCRIPTION OF DISPLAY.

Symbol	Description
	winter - DHW heating and room central heating buttons are enabled
	summer - only the DHW central heating function is enabled
	cooling - the cooling and DHW central heating function is enabled
	request for room central heating or cooling by CAR V2 remote control
	aqua celeris active/DHW comfort in progress
	request for DHW in progress
	room central heating in progress
RESET ESC ▽	description of functioning of the button (2, Fig. 6) - Reset, or esc
	displays room temperature and numerical data

Symbol	Description
	external temperature display
	internal temperature display
	function activation from remote
	functioning with holiday timer program
	batteries flat
	description of functioning state in use
	anomaly in boiler presence symbol
▷	indicates that it is possible to modify a parameter via the two buttons (11 and 12 Fig. 6)
	functioning with solar system active
	functioning with external temperature probe active
	functioning in wireless mode (not used on this model)

Symbol	Description
	description of functioning of the button (6, Fig. 6) - Menu or Ok
	flame presence symbol (only appears with the connection to some boiler models)
	symbols that identify the functioning mode in the hourly programming
	time bar that identifies the functioning period at “comfort” and “economy” temperature on the basis of the type of programming (cooling, central heating, DHW)
	functioning with automatic program
	functioning with manual program
	display of days of the week

N.B.: Some icons can assume different meanings according to the context, see the successive paragraphs to identify the functions activated by the presence of several icons at the same time.

3.1 Back-lighting (function available in the pre-set models).

By pressing any button the display lightens for a set time. If the batteries are present and charged the function is always active, in case the batteries are absent or run-down the well-functioning of the appliance is not compromised.

N.B.: CAR^{V2}, standard model equipped with boiler does not have backlighting function.

4. START-UP.

4.1 Programming current day and time.

Switch the remote control on by turning the main selector onto one of the functions available.

Press the button **PROG**  to enter time and current time mode and press the **OK** button to modify the settings.

On entering the programming mode, the time starts to flash. Modify the hour and minutes by pressing the **+ / -** buttons and the **OK** button to confirm. Select the day of the week and confirm using the **OK** button.

Once regulation has been completed, press the **ESC** button to escape the regulation mode.

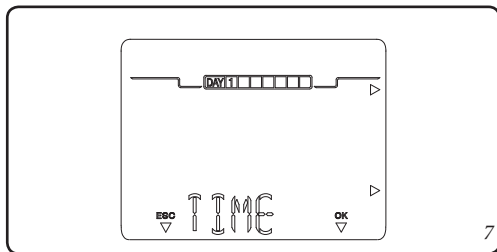

4.2 Selection of functioning mode.

According to the functioning mode selected, the CAR ^{v2} remote control performs the requests of the user, displaying the results on the display.

By turning the main selector (1, Fig. 6) the following functions can be selected: Stand-by/Anti-freeze, Summer, Winter, Cooling.

Note: the room anti-freeze function is active in the following modes: antifreeze, summer, winter.

- **Off mode.** The room anti-freeze function is not guaranteed in this mode (the boiler anti-freeze function remains active). The CAR ^{v2} remote control is off but remains powered and therefore the times and programs remain memorised.

- **Stand-by/anti-freeze mode** (*). In this mode, the boiler can only function in the event of anti-freeze request. In this state, the day, current time, any functioning anomalies and the room temperature are displayed (Fig. 8).
- **Summer mode** (☀). In this mode the boiler is enabled for producing domestic hot water excluding heating the environment. The display shows the day and the current time, the room temperature and hour bar with daily programming of the DHW timer along with the relative symbols (Fig. 9).
- **Winter mode** (❄). In winter mode the boiler is enabled for producing domestic hot water and for central heating the environment. In winter mode the CAR^{v2} remote control can function in automatic or manual mode. For the description of functioning see chapter 6. The display shows the day and current time, the room temperature and the hour bar with the daily programming of the central heating timer along with the relative symbols (Fig. 10).

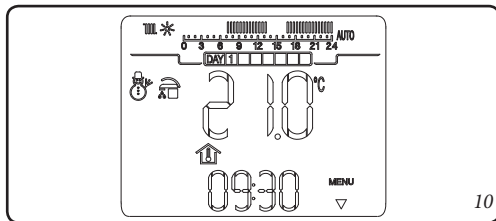
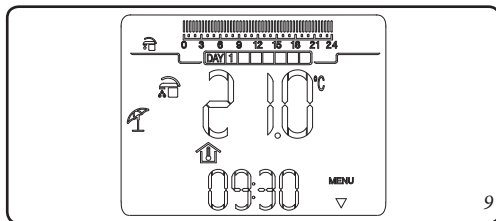
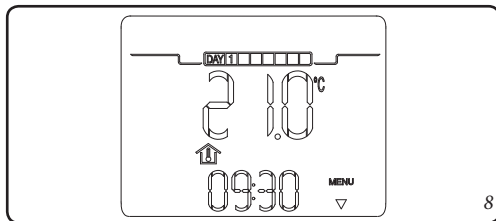

- **Cooling mode** (❄️). In cooling mode the boiler is enabled for the production of DHW and to control an external motocondensing (only for models set-up) for cooling rooms. In "cooling" mode the CAR v2 remote control can function in automatic or manual mode. For the description of functioning see chapter 7. The display shows the day and current time, the room temperature and the hour bar with the daily programming of the cooling timer along with the relative symbols (Fig. 11).

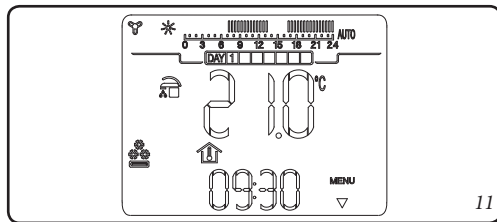

11

5. SUMMER MODE FUNCTIONS.

With the CAR ^{V2} remote control in summer mode (☀), only the production of DHW is enabled.

The boiler produces hot water according to the DHW temperature set on the CAR ^{V2} remote control.

5.1 DHW temperature setting.

By turning the selector (☰) it is possible to set the temperature of the DHW (see Fig. 12).

By turning in a clockwise direction the temperature increases and in an anti-clockwise direction it decreases.

The temperature is memorised after the selector remains still for a few seconds.

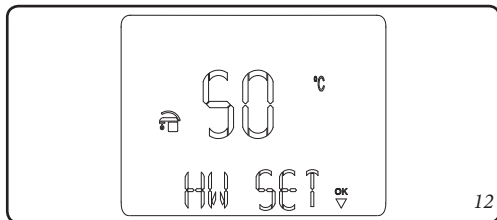

5.2 DHW timer (for storage tank unit).

If the temperature of the DHW contained in the DHW storage tank on two distinct levels (comfort and minimum) is to be regulated, this is possible using the “HW PRG” function. Regarding this, see the activation mode in the chapter relative to programming.

The “comfort” temperature corresponds to the value regulated on the DHW selector. The “minimum” temperature corresponds to the minimum DHW value envisioned for the boiler to which the CAR ^{V2} remote control is coupled.

N.B.: if the CAR ^{V2} remote control is functioning at minimum temperature level it is possible to force the DHW temperature by acting on the DHW selector.

The CAR ^{V2} remote control is factory set with the DHW always activated on "comfort" temperature (ON1 00.00 OFF1 24.00).

N.B.: the sanitary timer can also be used to set the time bands of the device “Aqua celeris” and “recirculation tank” if provided in in the boiler and depending on the communication protocol used.

6. WINTER MODE FUNCTIONS.

With the CAR ^{v2} remote control in winter mode (☺), the production of DHW and room central heating are enabled. Two main functioning modes can be selected for room central heating: automatic or manual. Plus a forced automatic timed program.

- Manual (☺): the room temperature is kept constant at the value set by the user every time, according to requirements.
- Automatic (AUTO): the room temperature is regulated on two levels (comfort and economy) during the day via a program set by the user.
- Forced automatic (☺ flashing): the room temperature is modified momentarily with respect to automatic functioning until the successive passage between comfort and energy mode of the automatic program set.

6.1 Manual functioning.

By pressing the AUTO ☺ button, pass alternately from automatic to manual functioning.

Once manual functioning mode is set, the ☺ icon switches on the display (Fig. 13).

To set the desired room temperature, just press the + / - buttons and the room temperature set will appear on the display (Fig. 14). Just wait a few seconds to confirm the new value.

In manual functioning mode it is possible to select any room temperature from +10°C to +35°C, which will be kept constant until new adjustments or selection of a different functioning mode.

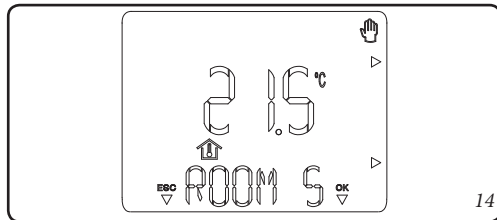
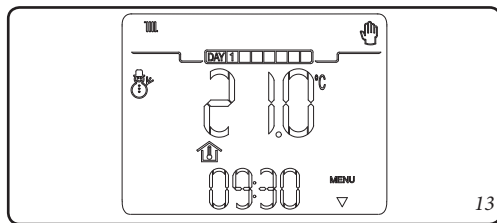

6.2 Automatic functioning.

The CAR^{V2} allows automatic functioning, in which a program manages the room temperature during the hours of the day.

The desired room temperature can be adjusted onto two independent levels: comfort (*^{*}) and economy (☾) via the  button, whose distribution throughout the day or the week is managed by hourly programming.

Press the button **AUTO**  until the icon switches-on on the display **AUTO**.

The CAR^{V2} is factory-set with a standard program stated in the table that follows. If this should not satisfy requirements, it is possible to modify it as described in the chapter relative to programming.

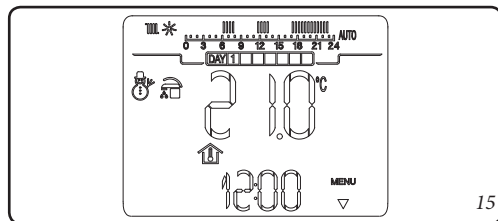



Days	☾ 16°C	* 20°C
Mon - Fri (Day 1 - 5)	from 23 to 6 from 8 to 11 from 13 to 17	from 6 to 8 from 11 to 13 from 17 to 23
Sat - Sun (Day 6 - 7)	from 23 to 7	from 7 to 23

16

Note: the system is designed to function on comfort and economy temperature levels depending on the hour program set. Therefore also during functioning on economy level, if the room temperature measured is below that set, the boiler can ignite.

6.3 Forced automatic functioning.

If in automatic functioning mode (**AUTO**) the room temperature is modified by pressing the + / - buttons, the forced automatic functioning mode is activated (displayed by the switch-on of the flashing  symbol). In this mode, the room temperature will be regulated to the value set until the next switch-on or switch-off phase of the automatic program set. The forced automatic function can be interrupted by simply pressing the **AUTO**  button.

6.4 Boiler flow temperature.

From the winter function mode (☼) it is possible to regulate the maximum boiler flow temperature. Regulate by rotating the selector (☼), clockwise to increase the maximum flow temperature and anti-clockwise to decrease it.

N.B.: during regulation, without the external temperature probe installed, the display shows “S. RIS” and the maximum flow temperature set value. On the other hand, with the external temperature probe installed, the display shows “OTC” and the indication of the correlation value of the maximum central heating flow temperature according to the external temperature (see Fig. 23).

The boiler flow temperature during normal functioning is however managed automatically of the CAR^{v2} remote control on the basis of the room temperature set. Therefore, it is not certain that the boiler works at the temperature set but functions at a lower flow temperature, but correct to obtain the desired room temperature.

If the external temperature probe is present, the flow temperature will be set according to that described in the "Special functions" chapter.

6.5 Room anti-freeze function.

The anti-freeze function has maximum priority with respect to other settings. When the room temperature drops below 5°C (adjustable, see special functions chapter) a central heating request is made at minimum of the power programmed. This situation remains active until there is a variation in room temperature of 0.6°C equal to 5.6°C measured in the room where the CAR^{v2} remote control is positioned.

6.6 Functioning in winter mode with external temperature probe.

If an external temperature probe is present, it is possible to set a flow temperature correction curve depending on the external temperature. By turning the selector switch (☼) the curve can be regulated from 0 to 9 according to the graphics Fig. 23. Regarding this, see the activation mode in the chapter relative to the special functions.

7. COOLING MODE FUNCTIONS.

With the CAR ^{V2} remote control in cooling mode (❄️), the of DHW heating and room cooling functions are enabled.

Attention: this function can only be used with Immergas appliances that manage the cooling mode.

Two main functioning modes can be selected: automatic or manual. Plus a forced automatic timed program.

- Manual (👤): the room temperature is kept constant at the value set by the user every time, according to requirements.
- Automatic (AUTO): the room temperature is regulated on two levels (comfort and economy) during the day via a program set by the user.
- Forced automatic (👤 flashing): the room temperature is modified momentarily with respect to automatic functioning until the successive passage between comfort and energy mode of the automatic program set.

7.1 Manual functioning.

By pressing the AUTO 👤 button, pass alternately from automatic to manual functioning.

Once manual functioning mode is set, the 👤 icon switches on on the display (Fig. 17).

To set the desired room temperature, just press the + / - buttons and the room temperature set will appear on the display (Fig. 18). Just wait a few seconds to confirm the new value.

In manual functioning mode it is possible to select any room temperature from +15°C to +40°C, which will be kept constant until new adjustments or selection of a different functioning mode.

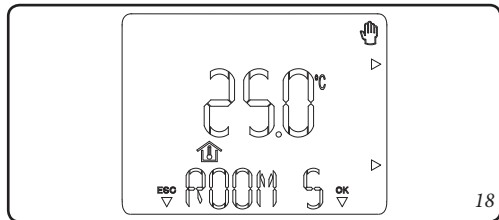
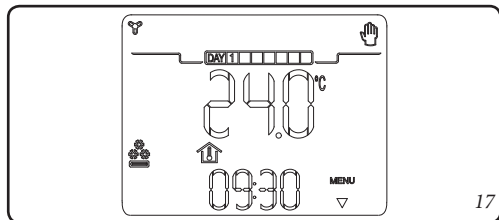

7.2 Automatic functioning.

The CAR^{v2} allows automatic functioning, in which a program manages the room temperature during the hours of the day.



The desired room temperature can be adjusted onto two independent levels: comfort (*^o) and economy (C^o) via the  button, whose distribution throughout the day or the week is managed by hourly programming.

Press the button **AUTO**  until the icon switches-on on the display **AUTO**.

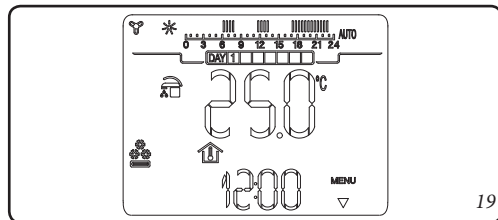
The CAR^{v2} is factory-set with a standard program stated in the table that follows. If this should not satisfy requirements, it is possible to modify it as described in the chapter relative to programming.





19

Days	 40°C	 25°C
Mon - Fri (Day 1 - 5)	from 23 to 11 from 13 to 17	from 11 to 13 from 17 to 23
Sat - Sun (Day 6 - 7)	from 23 to 13	from 13 to 23

20

Note: the system is designed to function on comfort and economy temperature levels depending on the hour program set. Therefore also during functioning in economy temperature conditions, if the room temperature measured is above that set, the chiller can switch-on.

7.3 Forced automatic functioning.

If in automatic functioning mode (**AUTO**) the room temperature is modified by pressing the + / - buttons, the forced automatic functioning mode is activated (displayed by the switch-on of the flashing  symbol). In this mode, the room temperature will be regulated to the value set until the next switch-on or switch-off phase of the automatic program set. The forced automatic function can be interrupted by simply pressing the **AUTO**  button.

7.4 Flow temperature.

From the cooling function (❄️), the system flow temperature during normal operation is managed automatically by the CAR^{V2} remote control on the basis of the set room temperature. If the room probe is excluded (Para. 12.1), the flow temperature will not be managed by the CAR^{V2} remote control but will be defined according to the parameters set in the internal hydronic unit.

If the external temperature probe is present, the flow temperature will be set according to adjustments in the internal hydronic unit.

N.B.: modulating flow temperature operation is only present on pre-set Immergas appliances.

8. INFORMATION.

By pressing the **INFO** button, access a menu that allows to verify the functioning state of the CAR^{V2} remote control. If a determined value is not present "--" will be displayed. The display of the "info" is subject to the boiler model and the method of connection of the CAR^{V2} remote control. Press the button repeatedly to scroll the list **INFO**. To go back to normal functioning mode, press the **ESC** button or wait 60 seconds.

The parameters that can be displayed are listed below:

- EXT T: external temperature (the optional external temperature probe if present).
- RH %: relative humidity in the room.
- HF TMP: central heating circuit flow temperature.
- HR TMP: central heating circuit return temperature.
- DWIN T: DHW input temperature.
- DHW T: DHW output temperature.
- PAN T: solar collector temperature.
- CH PRS: system pressure, central heating circuit.
- SERVIC: days remaining before periodic maintenance.

- VER P "x": "x" identifies the type of communication protocol with the boiler in use:
VER PC = CAR-Bus; **VER PI** = IMG-Bus.
The display shows the firmware version of the CAR^{V2} remote control
- ZONE: Not used on this model.

N.B.: the sizes displayed depend on the type of boiler to which the CAR^{V2} remote control is connected.

9. PROGRAMMING CAR ^{V2} REMOTE CONTROL.

Programming of the CAR ^{V2} remote control allows to set/modify the following parameters:

- comfort and economy temperature levels (different for the “central heating” and “cooling” modes);
- daily/weekly functioning time program (different for the “central heating” and “cooling” and “DHW” modes).

9.1 Setting comfort and economy room temperature.

The two temperatures are different depending whether they are in “winter” or “cooling” mode.

By pressing the  button, the “comfort” (Fig. 21) and “economy” (Fig. 22) temperatures are displayed alternately. To regulate both parameters, just press the + / - buttons to regulate the temperature according to requirements.

To confirm the new temperature, press the OK button, to exit without saving the modifications, press the ESC button.

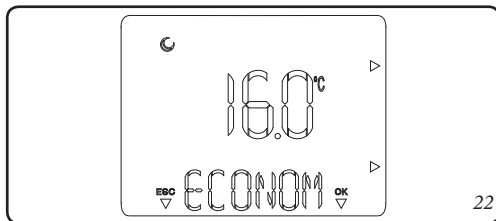
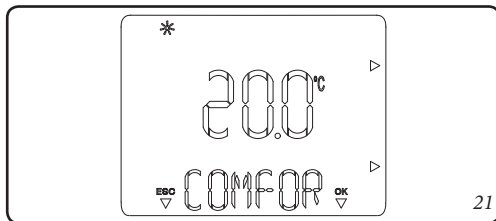

9.2 Programming functioning time.

By pressing the **PROG**  button, it is possible to enter the time periods programming window for programming the room temperatures and DHW timer (as well as setting the current time and day).

By pressing the + / - buttons, the items that can be set in the menu are displayed alternately.

There are, in fact, three types of program:

- **CH PRG:** room central heating program
- **HW PRG:** DHW heating program

The period in which the DHW temperature is in comfort will be distinguished by the switch-on of the  icon.

N.B.: the function must only be activated in the presence of a cylinder. The DHW is always active as per standard.

- **CHIPRG:** room cooling program

By following the points described below, it is possible to create or modify the time program selected.

1) Press the **PROG**  button, select the program to modify by pressing the + / - buttons, after which confirm by pressing the **OK** button.

2) Select the day of group of days by pressing the + / - buttons and confirm the selection by pressing the **OK** button:

- Monday, Tuesday, Wednesday... Sunday (individual day)
- Mon - Fri (from Monday to Friday)
- Sat - Sun (from Saturday to Sunday)
- Mon - Sat (from Monday to Saturday)
- Mon - Sun (from Monday to Sunday)

3) Set the functioning times with comfort and economy temperature. Within the 24 hours it is possible to define a maximum of 4 time periods with Comfort temperature, each of which is characterised by a switch-on time and a switch-off time.

The minimum variation of the switch-on and switch-off time is 30 minutes.

Set the first functioning period with comfort temperature (ON 1) indicated at the top and the switch-on time at the bottom. Press the + / - buttons to modify the switch-on time and press the **OK** button to memorise. At this point, pass to the next functioning period with comfort temperature (OFF) indicated at the top and the switch-off time at the bottom. Press the + / - buttons to modify the switch-off time and press the **OK** button to memorise.

When the first phase has been designed, pass automatically to the next functioning phases at comfort and economy temperature in order to program. This means repeating the points described previously up to phase 4.

The sequences of the On and Off states must always be sequential. For example, it is not possible to set “OFF 2” at 13.30 and “ON 3” at 11.00.

Once the day or group of days have been programmed, proceed in the same way for the remaining days and the remaining programs.

N.B.: if only 3 switch-on times are used, set the fourth with switch-on/off time at 24.

N.B. in automatic functioning conditions (AUTO) the display will show the 24 hour bar indicating the different time phases with Comfort or Economy temperature



. The presence of the hyphen on the time bar corresponds to functioning in Comfort mode.

10. DIAGNOSTICS AND ERRORS.

10.1 Diagnostics.

The CAR ^{v2} remote control continually controls the functioning status of the boiler and signals any anomalies, stating the corresponding error code on the display.

The error codes have meaning depending on the boiler to which the CAR ^{v2} remote control is connected. Therefore, refer to the boiler instruction book for a complete list of error codes and their relative meaning.

In the case of a fault that cannot be reset, contact a qualified technician (e.g. the After-Sales Technical Assistance Service).

“ERR>XX” appears on the display in the event of an error, where XX stands for the number that identifies the error code as well as the flashing  symbol.

As well as the error codes referring to the functioning state of the boiler, the CAR ^{v2} remote control also checks its own functioning state, indicating any malfunctions.

Code	Description
ERR>CM	Communication error between CAR ^{v2} remote control and boiler or switch-over phase between advanced type communication (e.g. Superior kW) and a normal type
ERR>TP	Error in reading the room temperature or value measured off scale (below 0°C or over 50°C)

10.2 Reset errors.

In the event of resettable boiler lock, the flashing **RESET** icon appears on the display. In this case, by acting on the relevant button and holding it down for 5 seconds, it is possible to send a release signal to the boiler that allows to reset correct boiler functioning within a few seconds. If normal functioning conditions are set, it goes back to functioning as previously set.

It is possible to operate up to a maximum of 5 consecutive reset attempts, after which an hour must pass before another 5 attempts are available.

10.3 Reset CAR ^{v2} remote control.

Acting on the hole for general reset (4, Fig. 6) the CAR ^{v2} remote control hardware can be reset without losing the settings made by the user, such as time, date and time prog.

If the CAR ^{v2} remote control original factory set conditions are to be restored, act as follows.

Press and release the button in the “reset” hole (4, Fig. 6) holding the **RESET** button down (2, Fig. 6).

At this point CAR ^{v2} remote control will be restored with all factory set data, keeping current time and day.

11. SPECIAL FUNCTIONS.

By pressing the **MENU** button, a list of options is accessed that allows to customise functioning of the CAR^{V2} remote control, according to the specific necessities.

To scroll the list, press the + / - buttons and press the **OK** button to select the desired function.

11.1 LANG (language selection).

Allows to set the functioning language of the CAR^{V2} remote control. It is possible to select from Italian (ITA as per standard) and English (ENG).

11.2 REGULT (Management of regulation parameter).

Allows to customise the functioning parameters of the CAR^{V2} remote control.

- CH MIN (central heating flow minimum temperature), allows to regulate the central heating flow minimum temperature value. Moreover, this value is used to calculate the curves used for the external probe. Values that are too high can cause flow temperatures that are too high on average for room central heating.
- OFFSET (regulation constant), constant that can be regulated from -15°C to +15°C and which in the presence of the external probe (optional) modifies the set flow temperature (see Fig. 23) set as per standard at 0°C.

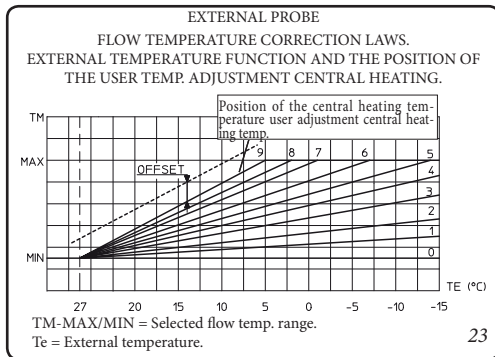

N.B.: if the self-learning function is enabled, the Offset value could be modified automatically.

- BUILD (dimension and building inertia), adjustable from 1 to 20, as per standard set on 10. It establishes the reaction speed of the system depending on the type of system present. For example:

Value	System type
5	system with little heat inertia
10	system with normal dimensions with radiators
20	system with a lot of heat inertia (e.g. floor-standing system)

- AUTO A (self-learning), defines the activation of self-learning, as per standard set at OFF. This function allows the CAR ^{v2} remote control to vary the offset, adapting it to the room in which it is installed.
- S RH % (room humidity) enables the desired room humidity to be adjusted during the cooling phase, which is adjustable from 20 to 90 %, default value 60 %. This value is adjustable only if a room humidity probe is present (optional).

11.3 HOLIDY (holiday program).

From winter functioning mode it is possible to define a number of days (from 1 to 99) during which the system deactivates both the hot water heating function and the room central heating function.

The value is decreased every midnight in the day change. At the end of the days set (the meter reaches 0) the previously active functions are restored. The activation of the holiday function is indicated by the flashing of the  icon and the count of the days remaining.

The holiday function can be deactivated by pressing the **AUTO**  button.

In the event of remote activation from telephone control, the boiler is activated with the settings of the telephone control, omitting the Holiday program.

N.B.: the room anti-freeze function is however guaranteed also in holiday mode.

11.4 LEGION (anti-legionella function).

Allows to activate the Anti-legionella function that takes the temperature of the cylinder to maximum allowed for 20 minutes. It is possible to select between the once a day at 2 in the night (ON 24H), every 7 days on Monday at 2 in the night (ON 7 DAYS) or deactivate it (OFF standard function).

N.B.: the function must only be activated in presence of boiler and eventually a thermostatic valve must be installed at the DHW output to prevent burns.

11.5 REMOTE (telephone control).

Allows to set the functioning of the CAR ^{v2} remote control in a way that, in the event of remote activation, it functions with the automatic time program if set at AUTO. Vice versa, it functions at continuous comfort temperature (without time program) if set at ON.

In the event of activation, it displays the flashing () icon.

Warning: it is possible to switch on the remote CAR ^{v2} only if it is set in one of the functioning modalities but Off and cooling mode.

11.6 CODE.

To use this function, see the “Functions protected by code” chapter.

12. FUNCTIONS PROTECTED BY CODE (CODE).

They are advanced character settings (reserved for an enabled technician), a four character code must be entered in order to access them (code: 1122).

Press the **MENU** button and scroll the options present until “CODE” appears, press the **OK** button and insert the code by selecting the characters using the + / - buttons and confirming them by pressing the **OK** button.

After which it is possible to display and modify the following functions.

12.1 AMB (room probe - On / Off or modulating functioning mode).

Allows to activate or deactivate the room probe present in the CAR ^{V2} remote control. On the basis of the parameter setting, it will be possible to regulate the following options:

- AMB: ON (standard value); it is possible to select a correction factor of the room probe reading and change the modulating function.
- AMB CR: room probe reading correction, the room probe range reading can be corrected within a range of + 3.0 - 3.0°C.

- **MODUL (On / Off or Modulating functioning):** allows setting functioning of the CAR ^{V2} remote control On/Off or Modulating. Set at ON, the flow temperature will be varied depending on the room temperature set. Set at OFF, the flow temperature will be kept constant until the desired room temperature is reached. (Setting to be made on systems with zones control unit).

N.B.: if an external temperature probe is present, the flow temperature will be set depending on the relative functioning curve.

- AMB: OFF, the system will not function, regulating the room temperature but only depending on the time program set. In this case the room anti-freeze function is not assured.

12.2 REDUCT (functioning in reduced mode).

if activated with AMB parameter at “OFF”, it defines how the flow temperature must be in Economy period.

- REDUCT OFF: in functioning periods in Economy mode, the boiler is switched-off.
- REDUCT ON: in functioning periods in Economy mode, it reduces the flow temperature by an amount equal to that set (adjustable from -1°C to -40°C).

12.3 FRO PR (anti-freeze level).

Allows to set the room temperature for activation of the anti-freeze function. Can be regulated from 0°C to 10°C and is set at 5°C as standard.

12.4 ZONE (function not present on this model).

12.5 SERVIC (programmed maintenance).

Sets the period for periodic maintenance (can be set from 6 to 24 months or “Off”). When the period has been set, the telephone number that the user must contact to perform periodic maintenance is set.

13. DISABLING THE CHRONO-THERMOSTAT.

If the CAR^{V2} must only be used as a boiler control (simple remote control function), proceed as follows, **based on the presence or absence of jumper X40, to be checked in the boiler wiring diagram.**

When indication is given to remove jumper X40 when the CAR^{V2} is connected:

- deactivate the room probe (par. 12.1);
- exclude all the time bands of the “PR RIS”, from 00:00 to 24:00;
- press the AUTO button to set the automatic mode.
- for the boiler to work in heating mode, the room thermostat contacts (40-41) on the boiler board must be closed.

Where jumper X40 must be maintained:

- deactivate the room probe (par. 12.1);
- activate all the time bands of the “PR RIS”, from 00:00 to 24:00;
- press the AUTO button to set the automatic mode.
- for the boiler to work in heating mode, the room thermostat contacts (40-41) on the boiler board must be closed.

14. REPLACE THE BATTERIES.

When  appears fixed together with “LOWBAT” on the display of the CAR^{V2}, the CAR^{V2} batteries must be replaced. Proceed as follow to make this replacement:

- Open the door (1, Fig. 3), remove the battery compartment lid (2, Fig. 3) and replace the batteries (5, Fig. 3).

15. DISPOSAL OF THE PRODUCT AT END OF LIFE.

Attention: at the end of its service life, the appliance must not be disposed of like normal household waste nor abandoned in the environment, but must be removed by a professionally authorised company as required by current legislation. Contact the manufacturer for disposal instructions.



16. TECHNICAL FEATURES.

- Dimensions (LxHxD):..... 142 x 103 x 31 (mm)
- Power supply: 24V nominal via twin-wire communication Bus
- CAR_BUS protocol power supply voltage:..... 24 ÷ 35 Vdc.
- CAR_BUS protocol maximum input:..... 10 mA - 350 mW.
- IMG_BUS protocol maximum power supply voltage:..... 18 Vdc.
- IMG_BUS protocol maximum input: 23 mA - 250 mW.
- Batteries:.....2 x 1.5 V AA
- Functioning room temperature: 0 - +40°C
- Warehouse temperature:.....-10 - +50°C
- Protection rating according to EN 60730:..... II
- Protection rating according to EN 60529:.....IP 20
- Connection technique:.....2 polarised wires
- Load reserve time: 8 hours for hourly count (with at least 2 hours of charge)
- Connection cable max. length: 50 m (with cable of 2x0.75mm²) (0.5 ÷mm² min - 1.5 mm² max)
- Precision indication room temp.: +/- 0.5°C to 25°C*
- NTC room temp. sensor:..... 50 k at 25°C
- Clock indication diversion +/- 15 minutes/year

* = the indication of the room temperature can be affected by the point of installation of the CAR ^{v2} remote control (e.g. hot wall, cold wall, height from the ground, etc.)

16.1 Product sheet.

In compliance with Regulation 811/2013, the class of the temperature control device is:

Class	Contribution to room central heating seasonal energy efficiency	Description
V	+3%	Modulating remote control
VI	+4%	Modulating remote control coupled to outer sensor

17. FACTORY SETTING.

- Functioning state Off
- Functioning program Manual
- Central heating Comfort temperature 20.0°C
- Central heating Economy temperature..... 16.0°C
- Cooling Comfort temperature 25.0°C
- Cooling Economy temperature..... 40.0°C
- Room temperature in manual..... 20.0°C
- Antifreeze..... 5.0°C
- Holiday Program..... HOLIDY = OFF
- Offset OFFSET = 0°C
- Building inertia dimension..... BUILD = 10
- Self-learning AUTO A = OFF
- Humidity value..... S RH % = 60 %
- Room Probe..... AMB = ON
- Reading Correction AMB CR = 0.0°C
- Reduction..... REDUCT = OFF
- Modulation MODUL = ON
- Telephone control REMOTE = ON
- Anti-legionella:..... LEGION = OFF
- Language:..... LANG = ITA (Italian)



This instruction booklet is made of ecological paper.



immergas.com

Immergas S.p.A.
42041 Brescello (RE) - Italy
Tel. 0522.689011
Fax 0522.680617

