

# Thermoregulation system for boilers



**INSTRUCTION FOR  
TECHNICIAN AND  
INSTALLER**



**Zone manager**

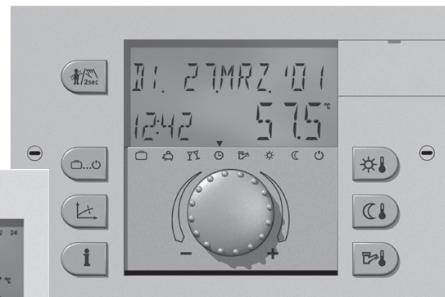

**Cascade and zones regulator**

# INDICE

<b>General safety devices.</b> .....	<b>4</b>
Regulators electrical connection. ....	4
Recommended diametres and lengths for the cables. ....	5
<b>Zones manager.</b> .....	<b>6</b>
Installation place.....	6
Installation.....	6
Electrical connection. ....	7
BUS address setting.....	7
<b>Cascade and zones regulator.</b> .....	<b>9</b>
Cascade and zones regulator installation. ....	9
Electrical installation. ....	9
Cascade regulator electrical connection.....	10
Zones and cascade regulator start up.....	11
Code entering for parameters modification. ....	11
AUTO-SET function.....	12
<b>Anomalies signalling.</b> .....	<b>13</b>
Anomalies register.....	14
<b>Example of configuration for the connection in cascade.</b> .....	<b>15</b>
Use of the cascade and zones regulator for installations in cascade.....	15
Use of the cascade and zones regulator with a single boiler for the management of different heating circuits.....	19

<b>Summary of parameters setting levels</b> .....	<b>21</b>
Hydraulic level. ....	24
System parameters level.....	27
Domestic hot water level. ....	29
Configuration level for direct / mixed 1 / mixed 2 heating circuits.....	31
Boiler configuration level. ....	33
Cascade configuration level. ....	34
BUS data configuration level.....	34
Solar configuration level (..VV..) .....	35
BUFFER configuration level (..VV..).....	37
<b>Technical data</b> .....	<b>38</b>
Cascade and zones regulator. ....	38
Zone manager.....	39
Sensors resistance values depending on the temperature. ....	40

## GENERAL SAFETY DEVICES.

All electrical connections must be executed by a professionally qualified and authorized technician in compliance with current standards and all applicable laws and regulations.

### Regulators electrical connection.

To reduce any trouble deriving from electromagnetic compatibility, please pay attention to the following rules:

- Electrical supply wires and bus data cables must be layed separately using a minimum distance of 2 cm.
- For cascade and zones regulators directly connected to the electricity network, the electric wires and the bus data cables must be layed separately.

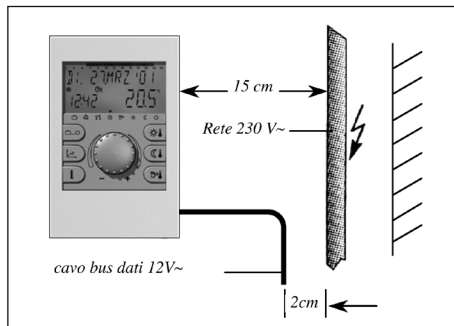

Picture 1: minimum distance for electric installation

- To install the zones managers a minimum distance of 40 cm must be kept from other electrical appliances with electromagnetic emissions such as timers (relays), engines, transformers, light regulators, microwave appliances, tv, speakers, computers, mobile phones, etc.

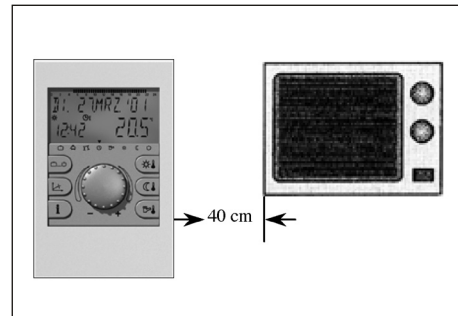

Picture 2: Minimum distance from other electric appliances

- A minimum distance of 40 cm must be kept between cascade regulator and zones manager. More cascade and zones regulators connected through the bus data can be installed one next to the other.

## Recommended diametres and lengths for the cables.

- Screened cables are recommended for the bus data network.  
Recommended types: J-Y(St)Y 2 x 2 x 0.6  
Max. length: 50 meters.
- The earth connection of the cable screening must be done once only . It is not allowed to ground the same cable in more than one point (see picture 3-4).
- Electric supply cables  $\text{Ø} = 1,5 \text{ mm}^2$ .
- Low voltage cables (for example sensors)  $\text{Ø} = 0,5 \text{ mm}^2$  max length 100 meters.

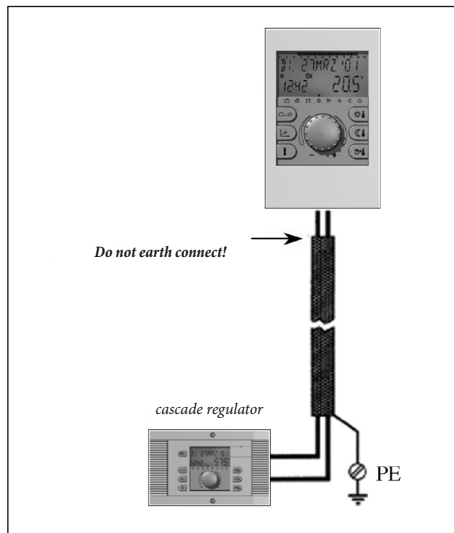

Picture 3: earth connection of the cable screening only in one point.

A double earth connection cannot be effected in case of star network of bus data.

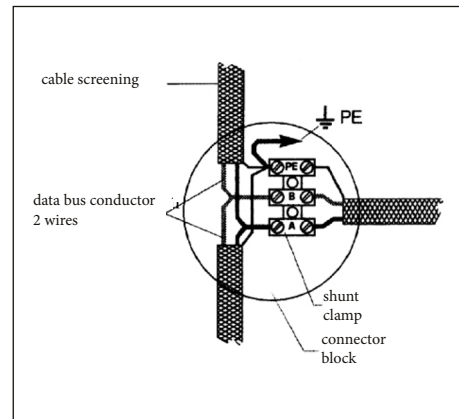

Picture 4: Star network of bus data.

The earth connection must be effected on one side of the star!

## ZONES MANAGER.

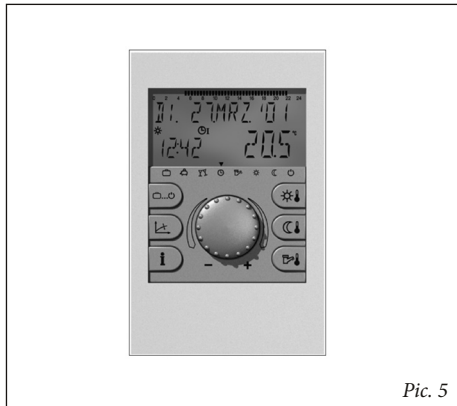

### Installation place.

a - Use without ambient probe.

If the ambient probe is not activated, the appliance can be installed everywhere.

b - Use with ambient probe.

If the room thermostat is activated, the appliance must be located at a height of 1,20-1,50 m and in a suitable position for

correctly measuring the temperature. For this purpose an intermediate wall of the coldest zone can be chosen.

The appliance must not be installed:

- in places directly exposed to sunlight.
- in the vicinity of appliances that produce heat such as TV sets, refrigerators, wall lamps, radiators, etc.
- on walls behind which there are heating pipes or flues.
- on not insulated external walls.
- in corners or recesses, on shelves, or behind the curtains.
- near entrance doors of not heated rooms.

### Installation.

After opening the upper part, the wall support can be fixed in the required place with the screws and plugs supplied.

The data bus cable must pass through the lower opening.

Recommended connection cable: J-Y(ST)Y 2 x 0.6

Max length: 50 m.

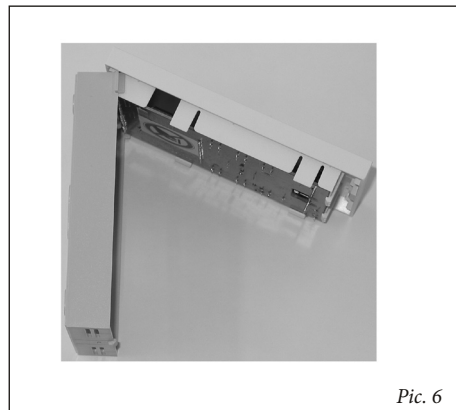

Wall support (without upper part)

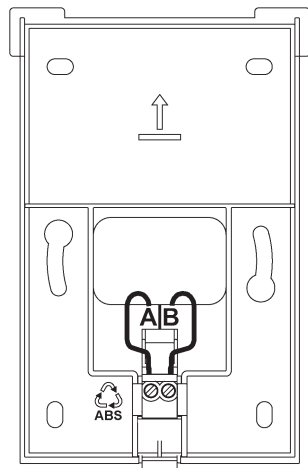

### Electrical connection.

The two wired data bus cable must be connected to A and B terminals .

The connection must be executed respecting the polarity. The display does not show anything whenever polarity is not respected. After connecting electrically the zone manager, refit the front cover till the clamping.

### BUS address setting.

The connection between zones managers and cascade regulator must be obtained through a data bus cable with two wires. Since the zone managers are connected in parallel to the data bus cable, the data transmission requires a bus address.

### BUS address (zone manager).

The bus address classification between cascade regulators and zone managers is defined by a rigid scheme set by the producer as explained in the following scheme:

**Attention:** respect the polarity when connecting the data bus cable (A-B).

Pic. 7

Cascade regulator		Relative zone manager	
Function	BUS Address	Heating circuit	BUS Address
Main cascade regulator	10	direct circuit	11
		mixed circuit 1	12
		mixed circuit 2	13
II° cascade regulator	20	direct circuit	21
		mixed circuit 1	22
		mixed circuit 2	23
III° cascade regulator	30	direct circuit	31
		mixed circuit 1	32
		mixed circuit 2	33
IV° cascade regulator	40	direct circuit	41
		mixed circuit 1	42
		mixed circuit 2	43
V° cascade regulator	50	direct circuit	51
		mixed circuit 1	52
		mixed circuit 2	53

## BUS address entry in the zone manager.

- First start-up.

After completing the installation and starting up the system, all available segments are visualized on the zone manager display.



Soon after the instrument identification and the bus address are visualized.

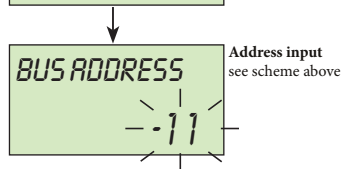
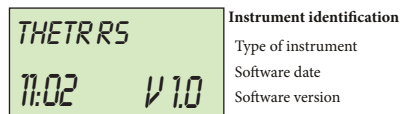

After the bus address input and confirmation, pressing the knob, automatically the associated heating circuit is visualized:

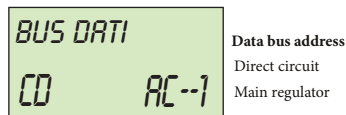

### Attention:

Double assignments of the same data bus address cause errors during the data transmission and faults of system adjustments.

- Bus address change.

To change a bus address, it's necessary to follow the procedures below :

- 1 - to cut off the bus data cable from the zone Manager
- 2 - to fix again the zone Manager pressing the turnable knob till the bus address is visualized.
- 3 - to insert the new bus address and confirm.



## CASCADE AND ZONES REGULATOR.

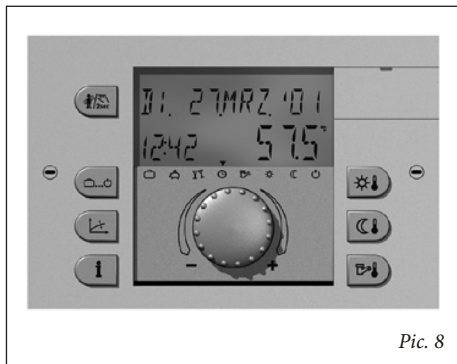

### Cascade and zones regulator installation.

The cascade regulator is designed for flush-mounted installation.

The fixing is done turning clockwise the two lateral screws (1).

Turn anti-clockwise for disassembling.

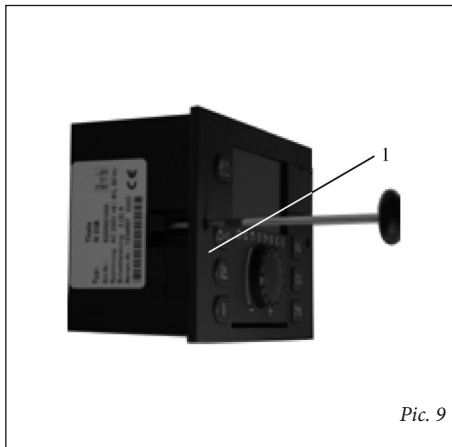

### Electrical installation.

The electrical connection and wiring must be done in the back side of the appliance as reported in the following page scheme.

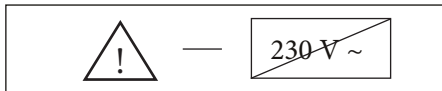

All the connection terminals inside the blue area (X1) work with safety low voltage and they have not to connect to the main supply voltage. If this happens the appliance will destroy and you will lose the warranty!

The connection terminals inside the red area (X2...X4) work with the main supply voltage.

### Warning:

- For the wiring of the appliance the bus data and sensors cables must be layed **separately** from electric wires. Sensor and bus data cables cannot be layed **together** with electrical supply wires of other electrical appliances.
- For the connection it is necessary to use the special screwing connector (X1÷X4) provided.

## Cascade regulator electrical connection.

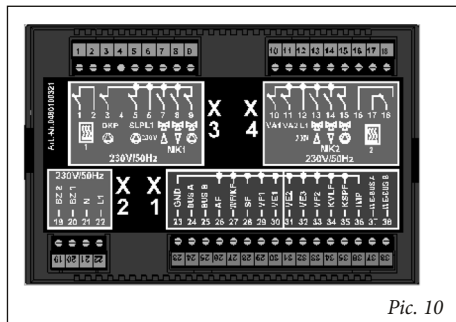

Pic. 10

### Main supply connection.

- 1 - Relay output (not used)
- 2 - Relay input (not used)
- 3 - Direct circuit pump (HC)
- 4 - N.C.
- 5 - Domestic hot water circuit pump
- 6 - L 1/ 230 V (main supply)
- 7 - Mixed circuit valve (MC 1) OPEN
- 8 - Mixed circuit valve (MC 1) CLOSED
- 9 - Mixed circuit 1 pump
- 10 - Variable output relay 1
- 11 - Variable output relay 2
- 12 - L 1 230/V
- 13 - Mixed circuit valve (MC 2) OPEN

- 14 - Mixed circuit valve (MC 2) CLOSED
- 15 - Mixed circuit 2 pump
- 16 - N.C.
- 17 - Relay output (not used)
- 18 - Relay input (not used)
- 19 - (not used)
- 20 - (not used)
- 21 - N/230V
- 22 - L1 /230V

### Low tension connections.

- 23 - GND common
- 24 - Data bus connection - signal A (zone controls and room thermostats)
- 25 - Data bus connection - signal B (zone controls and room thermostats)
- 26 - External sensor (not to use, connect to the boiler)
- 27 - (not to use)
- 28 - Domestic hot water sensor
- 29 - Temperature sensor zone 1
- 30 - Variable input 1
- 31 - Variable input 2
- 32 - Variable input 3
- 33 - Temperature sensor zone 2
- 34 - Solar panel sensor
- 35 - Solar storage tank sensor
- 36 - Impulses input
- 37 - Boiler data bus A
- 38 - Boiler data bus B

**NOTE:** For the connection to the hydraulic circuit components see the schemes at pages 15-19.

### Bus address (Cascade regulator).

In case that only one cascade regulator is installed, the bus address is always 10. With more regulators connected (at least five) the regulator directly connected to the boiler must have the bus address 10. For the other regulators, the addresses must follow numbers 20, 30, 40 e 50.

## Zones and cascade regulator start up.

### Segment test and instrument identification.

At the first appliance start up or when power supply is restored all the display segments are visualized:

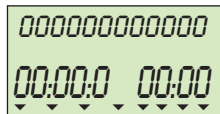

Segment test

The instrument model with its type code and software version is then displayed.

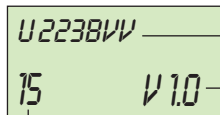

Type of instrument

software version

type code

If no errors are signalled, the standard display appears indicating date, time and current boiler temperature.

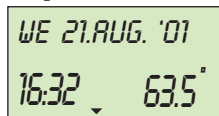

Standard display

Wednesday 21 August 2001  
time 16:32 Temperature 63,5°C

The active summer switching-off appears on the standard display with a sunshade symbol (☼).

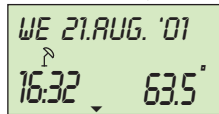

Summer switching-off

active

The active anti-freeze function appears on the standard display with a snow crystal symbol (\*).

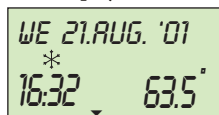

Anti-freeze protection



active

## Code entering for parameters modification.

### Technician code.

After entering the code, the parameters reserved for the technician are activated: these ones can be modified according to the characteristics of the system.

### Code entering.

For entering the technician code it's necessary to press at the same time the buttons  and  for approx. 3 seconds until the word "code" appears on the display.

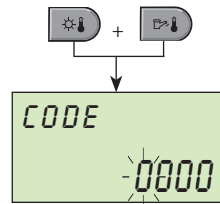

Turn the knob to set the code number in the flashing area, and press the knob for storing the code entered.

**NOTE:** The code is supplied on request by the IMMERGAS technical service.

If the code is correct the words “INSTALLER OK” appear on the display. In case of error the write “CODE ERROR” is visualized.



**Attention:** if any operation is executed for ten minutes the code must be re-entered.

After the code is entered, all the parameters reported in the tables from page 24 to page 35 can be modified.

The following menus are available in addition to the ones listed in the “user” section of this manual:

- **HYDRAULIC:** for the settings related to the system realized;
- **HEAT GENERATOR:** to set the kind of boiler;
- **SOLAR:** to regulate the settings of a possible-

- solar panel;
- **CASCADE:** to regulate the settings for the cascade functioning;
- **BUFFER:** to regulate the settings of a possible storage buffer;
- **BUS:** to set the BUS address;
- **RELAY TEST:** to activate the relays of the regulator manually;
- **ALARM:** to visualize the anomalies of the functioning;
- **SENSOR ADJUSTMENT:** to modify the temperatures values of the sensors.

### **AUTO-SET function.**

Thanks to this function, it is possible to set automatically the presence of heating and domestic hot water circuits with sensors are connected to the regulator.

The AUTO - SET is activated after the switch on of the appliance and it works for the following 24 hours.

If during the first start-up, a configuration is registered, its change is possible only if the AUTO - SET function is activated. This activation can carry out cutting off the power supply and to restore it pressing the knob.

## ANOMALIES SIGNALLING.

The cascade and zones regulator displays and stores every time all the anomalies that happen.

There are four different types of anomalies:

### 1 - Sensor anomalies signalling.

The values of the sensors resistance that are out of range are considered as fault. According to the specific function the faults are indicated by code 10...20; according to the type of fault, code 0 indicates the short circuit and code 1 signals the cutoff.

### 2 - Control errors signalling.

These error codes estimate the result of the regulations. These anomalies are indicated through codes 50...60 and index 0, 1 or 2.

### 3 - Bus errors signalling.

These codes signal possible address errors such as a double address or the non-recognition of a bus address. These anomalies are indicated through code 70 and index 0 or 1.

### 4 - Boiler electronic card errors signalling.

These error codes are related to the boiler electronic card and they are divided in two

types: operational anomalies with manual reset with code En-XX (see instruction manual) and operating anomalies with electric reset (automatic reset) with code Bn-XX (see instruction manual).

### Errors management:

- anomalies are visualized on the regulator display.
- system anomalies are visualized in the information level with the related value.
- if necessary the errors are saved in the error register (see description below).
- setting the parameters properly, the errors activate an error signalling output for the connection to an optical or acoustic signal.

## Anomalies signalling tables:

### *Sensors and variable inputs:*

Description	Fault type	Code
External sensor	Cutoff	10-0
External sensor	Short circuit	10-1
Boiler sensor	Cutoff	11-0
Boiler sensor	Short circuit	11-1
Delivery sensor MC 1	Cutoff	12-0
Delivery sensor MC 1	Short circuit	12-1
Domestic hot water sensor	Cutoff	13-0
Domestic hot water sensor	Short circuit	13-1
Variable input VI2	Cutoff	14-0
Variable input VI2	Short circuit	14-1
Variable input VI2	Anomalies signal	14-7
Variable input VI3	Cutoff	15-0
Variable input VI3	Short circuit	15-1
Variable input VI3	Anomalies signal	15-7

Common delivery sensor	Cutoff	16-0
Common delivery sensor	Short circuit	16-1
Solar boiler sensor	Cutoff	17-0
Solar boiler sensor	Short circuit	17-1
Delivery sensor MC 2	Cutoff	18-0
Delivery sensor MC 2	Short circuit	18-1
Solar panel sensor	Cutoff	19-0
Solar panel sensor	Short circuit	19-1

**Temperatures:**

Boiler delivery temperature	not reached	50-4
Boiler delivery temperature	exceeded	50-5
D.h.w. circuit delivery temp.	not reached	51-4
Delivery temperature MC 1	not reached	52-4
Delivery temperature MC 2	not reached	53-4
Room temperature DC	not reached	54-4
Room temperature MC 1	not reached	55-4
Room temperature MC 2	not reached	56-4

**BUS data:**

Address	addresses conflict	70-0
Activity	no signal	70-1
Activity	communication with boiler missed	70-6
EEPROM		71-0
EEPROM	faulty	71-1

**Boiler errors:**

Error	block* (manual reset)	En-XX
Error	block* (electrical reset)	Bn-XX

\* see the boiler instruction manual

**Anomalies register.**

The standard regulator is provided with an anomalies register where up to five errors can be stored. These fault signals are visualized in the menu “alarm” together with date, time and type of the error. Entering this menu protected by code; the most recent fault is visualized, then turning the knob it is possible to display all the 5 fault reports.

# EXAMPLE OF CONFIGURATION FOR THE CONNECTION IN CASCADE.

Use of the cascade and zones regulator for installations in cascade.

With VICTRIX boiler and cascade regulator it is possible to connect in cascade up to three boilers as shown in the hydraulic scheme below:

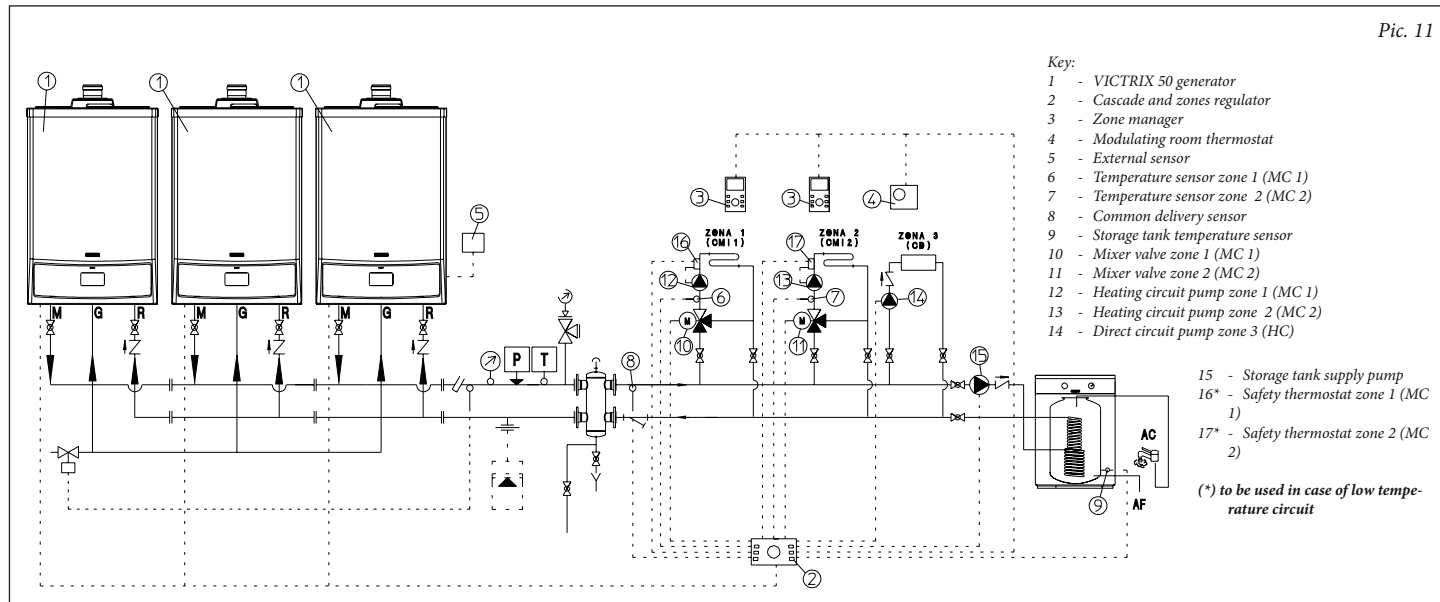

Pic. 11

NOTE: for other connection diagrams, to consult the boiler instructions manual.

Concerning the electrical connection of the components to the cascade regulator, see the following scheme:

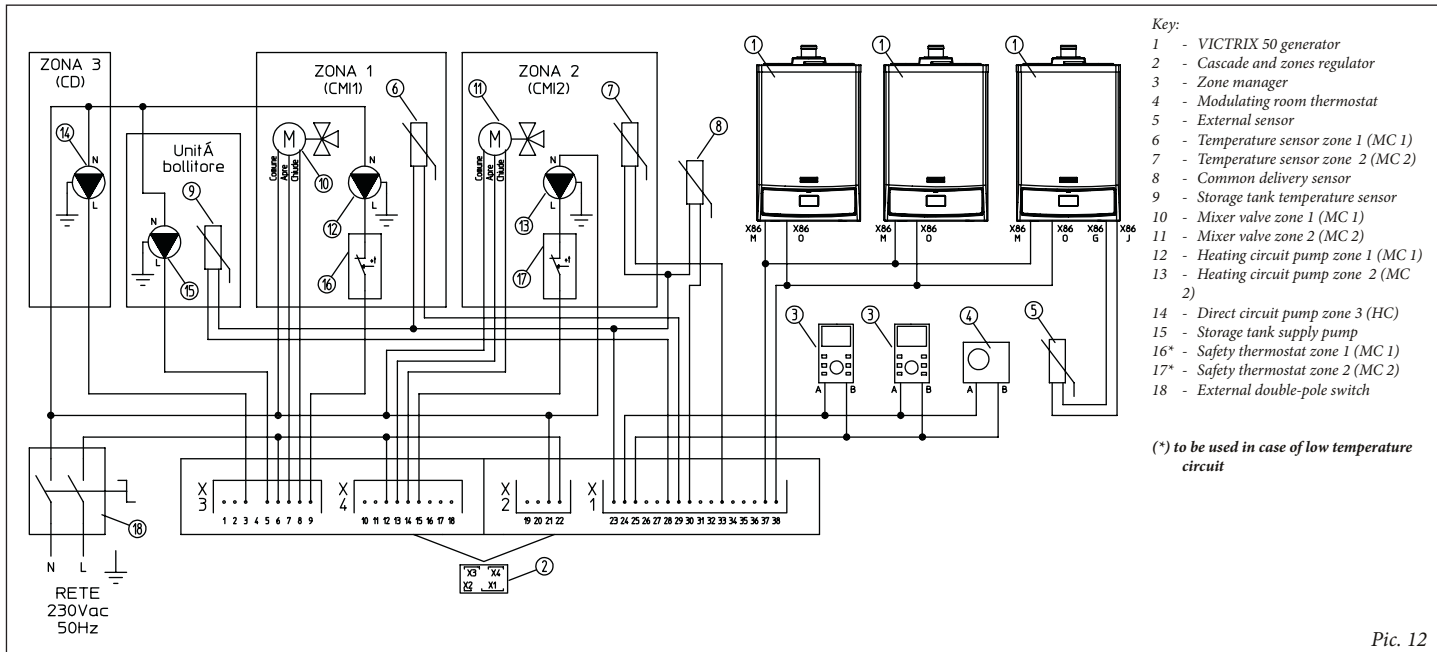

Pic. 12



Once the scheme of picture 12 is realized, it is necessary to set the bus address on the electronic card of each single boiler as explained in the picture below:

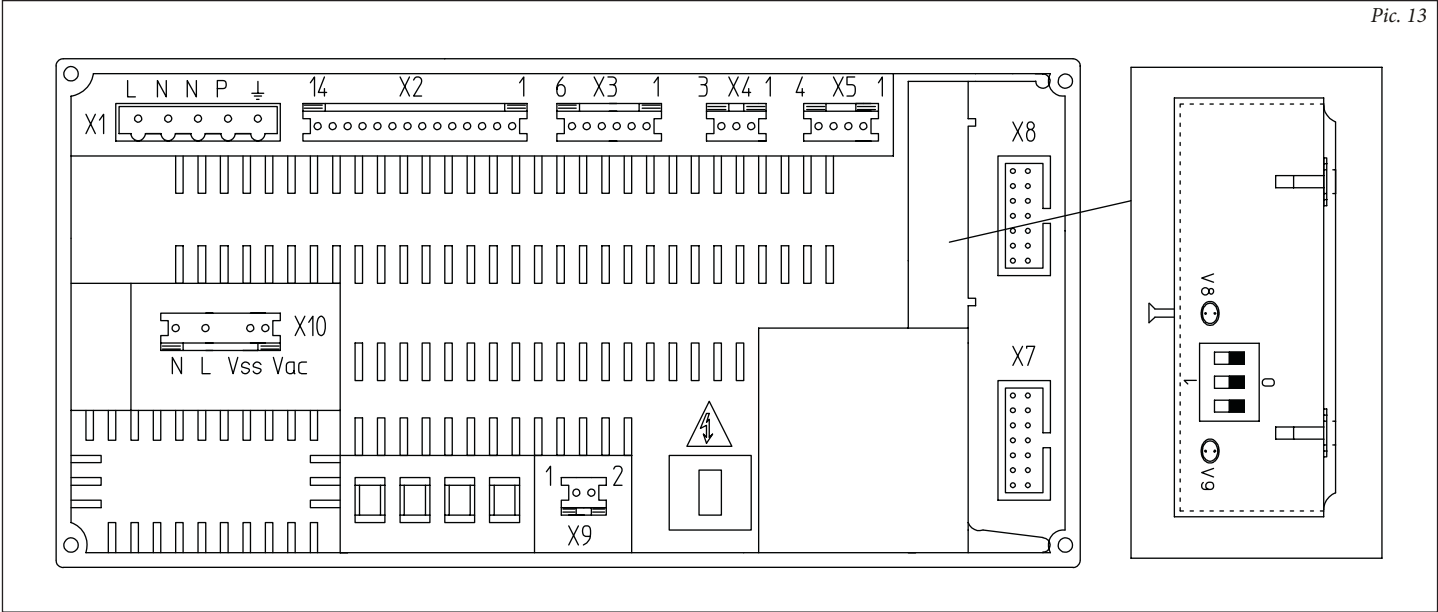

Pic. 13

Address 1 (1st boiler)

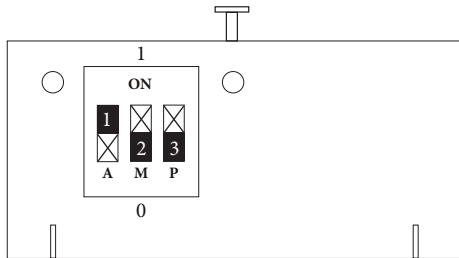

Address 2 (2nd boiler)

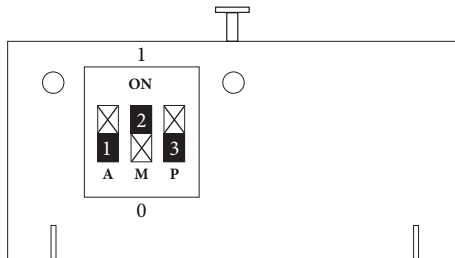

Address 3 (3rd boiler)

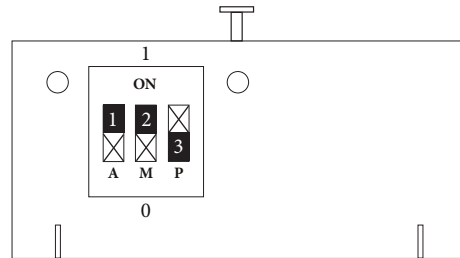

The parameters for the functioning in cascade are already set into the “cascade” menu of the regulator.

## Use of the cascade and zones regulator with a single boiler for the management of different heating circuits.

The cascade and zones regulator can be used even with one single VICTRIX boiler to manage up to three heating zones. In this case, it is possible to realize the following hydraulic scheme as explained in picture 14; the respective electrical connections are shown in picture 15.

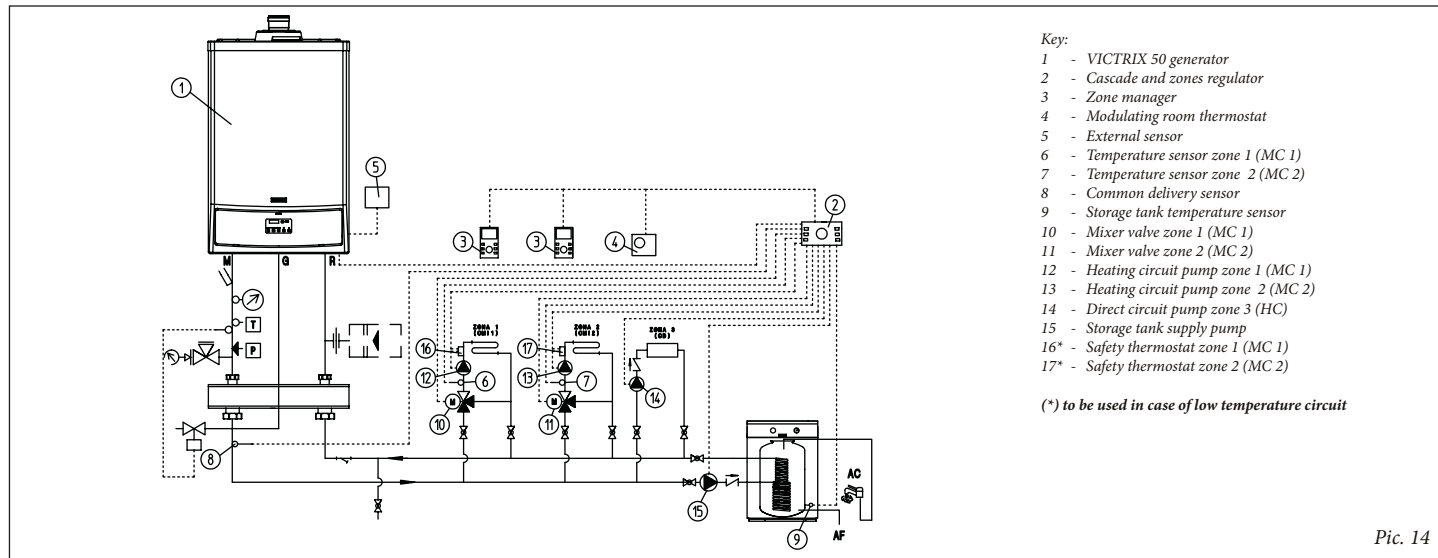

Pic. 14

**NOTE:** for other connection diagrams, to consult the boiler instructions manual.

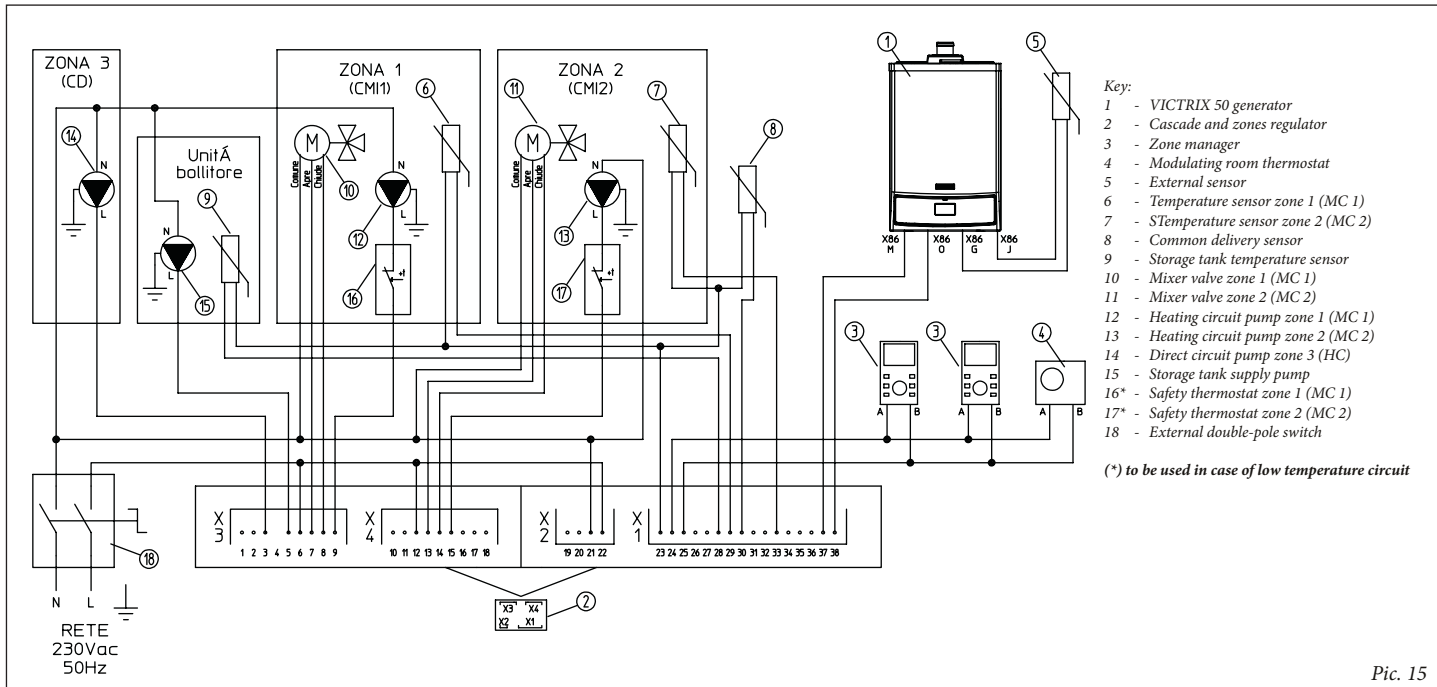

Pic. 15

## SUMMARY OF PARAMETERS SETTING LEVELS.

Press for 3 seconds the knob. Select with the knob the desired level and confirm after inserting the code. **Parameters in grey color:** freely accessible. All the other parameters are accessible only inserting the code.

Parameter	Programming		Configuration		Parameters setting (heating circuits, regulations)							Communication	Heating circuit, regulations	
	Time - Date	Time/programs	Hydraulic	System	Domestic hot water	Direct circuit	Mixed circuit 1	Mixed circuit 2	Heat generator	Cascade	Solar menu	BUS	Relay test	Alarm
1	Time	Circuit selection	Hydraulic scheme	LANGUAGE	ECO TEMPERATURE	Reduced heating eco/reduction	Reduced heating eco/reduction	Reduced heating eco/reduction	Heat generator type	Delivey temperature differential	Hysteresis ON	Cascade regulator BUS address	Generator	Error 1
2	Year	Program selection	D.h.w. pump	TIME-PROGRAM	ANTILEGION. PROTECTION (day)	Heating system	Heating system	Heating system		Start delay	Hysteresis OFF	HC remote control	HC pump	Error 2
3	Day/Month	Day selection	MC 1 pump	OPERATING MODE	Antilegionella Hour	Room sensor activation	Room sensor activation	Room sensor activation	Minimum heat generator temperature	Stop delay	Min. run time solar pump	MC 1 remote control	MC1 pump	Error 3
4	Time-change summer/winter	Switch-on time (08:00)	MC 2 pump	SUMMER (switching off)	Antilegionella temperature	Room sensor influence	Room sensor influence	Room sensor influence	Maximum heat generator temperature	Switching-on heat output	Solar collector max. temperature	MC 2 remote control	CMI-1 mix actuator	Error 4
5		Switch-off time (22:00)	HC pump	Anti freeze protection (choice)	D.h.w. sensor type	Heating curve auto-adj.	Heating curve auto-adj.	Heating curve auto-adj.		Sequence reversal	Solar tank max. limit		MC2 pump	Error 5
6		Temperature (20.0)	VO1 output	Contact for request VI1	D.h.w. max. temperature	Pre-ignition	Pre-ignition	Pre-ignition		Master Unit	Solar operational mode		CMI-2 mix actuator	
7			VO2 output	Contact for request VI2	D.h.w. working mode					Peak boiler	Inhibition heat generation alternance (only with parameter 06=1)		D.h.w. pump	

Parameter	Programming		Configuration		Parameters setting (heating circuits, regulations)							Communication	Heating circuit, regulations	
	Time - Date	Time/programs	Hydraulic	System	Domestic hot water	Direct circuit	Mixed circuit 1	Mixed circuit 2	Heat generator	Cascade	Solar menu	BUS	Relay test	Alarm
8			VI1 input	Contact for request VI3	Anti-drain function	Room anti-freeze protection	Room anti-freeze protection	Room anti-freeze protection		Base change/ peak	Change priority/ parallel mode		UV-1	
9			VI2 input	Climatic zone	D.h.w./delivery temp. $\Delta T$	Room thermostat function	Room thermostat function	Room thermostat function			Solar energy balance		UV-2	
10			VI3 input	Building type	Thermostat hysteresis	External temperature adjustment	External temperature adjustment	External temperature adjustment			Reset energy balance			
11			Indirect return	Exit time	Post-circulation	Constant temperature (nominal value)	Constant temperature (nominal value)	Constant temperature (nominal value)			Volumetric flow rate			
12				Anti-blocking function	Recirculating pump timer	Min. delivery temperature	Min. delivery temperature	Min. delivery temperature			Density HTM - medium			
13				Errors signalling	Recirc. interval (pause)	Max. delivery temperature	Max. delivery temperature	Max. delivery temperature			Heat capacity HTM			
14				AUTO-SET function	Recirc. interval (period)	Delivery temperature increasing	Delivery temperature increasing	Delivery temperature increasing			Final switch-off temperature			
15				Setting reset		Post-circulation	Post-circulation	Post-circulation			Commutation delay			
16											Commutation temperature for run valve			
17									Max flue temperature					

Parameter	Programming		Configuration		Parameters setting (heating circuits, regulations)							Communication	Heating circuit, regulations	
	Time - Date	Time/programs	Hydraulic	System	Domestic hot water	Direct circuit	Mixed circuit 1	Mixed circuit 2	Heat generator	Cascade	Solar menù	BUS	Relay test	Alarm
23				Protection code										
24				Fahrenheit temperature										
25									Max external temperature lock					
26									Delivery temp. start increasing					
37			Total reset	Total reset										

## Hydraulic level.

PARAMETER	Description	Regulation	Setting range / Parameters
01	Hydraulic scheme	0	0000, .... 9999
02	D.h.w. pump output assignment	1	OFF No functions 1 Domestic hot water pump 4 Recirculation pump 5 Electric heating
03	Mixed circuit 1 pump output assignment	3	OFF No functions 2 Direct circuit depending on climatic conditions 3 Mixer circuit depending on climatic conditions 6 Constant temperature regulator 7 Fixed value regulator 8 Return increasing
04	Mixed circuit 2 pump output assignment	3	Setting range and configuration: see parameter 03
05	Direct circuit pump output assignment	2	OFF No functions 2 Direct circuit pump 4 Recirculating pump 5 Electric heating rod 6 Constant regulation 10 Boiler supply pump 11 Boiler circuit pump 1 12 Boiler circuit pump 2 13 General anomalies 14 Timer 15 Solar pump 21 Generator parallel request 27 Buffer control



PARAMETER	Description	Regulation	Setting range / Parameters
06	Variable output 1 assignment	OFF	OFF No functions 4 Recirculating pump 5 Electric heating rod 9 By-pass pump 10 Boiler supply pump 11 Boiler circuit pump 1 12 Boiler circuit pump 2 13 General anomalies signalling 15 Solar supply pump 16 Tampon tank supply pump 17 Solid fuel supply pump 18 Tank supply pump 19 Solar supply commutation valve 20 Solar forced dissipation control 21 Generator parallel request 26 Priority pump 27 Buffer control
07	Variable output 2 assignment	OFF	Setting range and configuration: see parameter 06

PARAMETER	Description	Regulation	Setting range / Parameters
08	Variable input 1 assignment	13	OFF No functions 1 External sensor 2 2 Boiler sensor 2 3 Tank sensor 2 4 Buffer sensor 2 5 Request contact 6 Faulty external input 9 Return sensor 10 Boiler external lock 11 External modem activation 12 External information 13 Delivery manifold sensor 14 Solar manifold return sensor 16 Flue sensor 18 Solid fuel tampon sensor 19 Buffer sensor 1 27 Not activated
09	Variable input 2 assignment	OFF	Adjustment field and assignment as parameter 08, but without adjustment possibility (flues sensor)
10	Variable input 3 assignment	OFF	Adjustment field and assignment as parameter 08, but without adjustment possibility (flues sensor)
11	Indirect return increasing	OFF	OFF, ON (disactivated - activated)

## System parameters level.

The parameters of this section are referred to general parameters and to values set into the heating circuit.

PARAMETER	Description	Regulation	Setting range / Parameters
LANGUAGE	Selection of the language	IT	DE German GB English FR French IT Italian NL Dutch ES Spanish PT Portuguese HU Hungarian CZ Czech PL Polish RO Rumanian RU Russian TR Turkish S Swedish N Norwegian
TIME-PROGRAMS	Programs number, d.h.w. and heating timers	P1	P1 Only one time-program activated P1-P3 Three time-programs activated
CONTROL MODE	Common or separated control mode	2	1 Common regulation for all heating circuits 2 Separated regulation for each heating circuit
SUMMER	Summer switching-off temperature	20 °C	OFF not activated parameters 5 ... +30 °C
05	Anti-freeze temperature	0 °C	OFF not activated -20...parameters 4
06	Circuit activated by the request contact IV 1	1	1 Direct circuit 2 Mix circuit 1 3 Mix circuit 2 4 D.h.w. ALL All circuits
07	Circuit activated by the request contact IV 2	1	1 Direct circuit 2 Mix circuit 1 3 Mix circuit 2 4 D.h.w. ALL All circuits

PARAMETER	Description	Regulation	Setting range / Parameters
08	Circuit activated by the request contact IV 3	1	1 Direct circuit 2 Mix circuit 1 3 Mix circuit 2 4 D.h.w. ALL All circuits
09	Climatic zone	- 5°C	-20...0°C
10	Building type	2	1 light building 2 normal building 3 heavy building
11	Time for returning to standard display	2 Min	OFF no automatic exit 0,5...5 Min exit after the set time and automatic return to standard display
12	Mixing valves and circulating pump anti-lock function	ON	ON activated OFF deactivated
13	Errors signalling	ON	OFF no visualization ON visualization activated
14	AUTO-SET function	ON	OFF automatic sensors setting deactivated ON automatic sensors setting activated
18	Temperature cycle	OFF	ON, OFF activated or deactivated
19	Anti-freeze mode	OFF	OFF permanent according to par. 5 0,5 - 60 timed minutes
23	Protection code	OFF	0000, ..., 9999
24	Temperature visualization in Fahrenheit degrees	OFF	OFF, ON
RESET	Parameters reset		Do not activate except in case of extreme necessity

## Domestic hot water level.

This section includes all the necessary parameters for programming the domestic hot water circuit.

PARAMETER	Description	Regulation	Setting range / Parameters
D. H. W. NIGHT	Reduced temperature for domestic hot water	40 °C	5 °C ... Domestic hot water temperature
ANTILEGIO-NELLA DAY	D.h.w. legionella protection function (day)	OFF	OFF No Legionella protection function Mo...Su Legionella protection in the selected day All Legionella protection each day of the week
03	D.h.w. legionella protection function (time)	02:00	00:00...23:50
04	Legionella protection (temperature)	60 °C	10 °C ... D.h.w. maximum temperature
05	D.h.w. temperature sensor type	1	1 D.h.w. temperature sensor 2 D.h.w. thermostat
06	D. h. w. maximum temperature	60 °C	20 °C ... maximum heat generator temperature
07	D. h. w. functioning mode	2	1 Parallel functioning 2 Priority functioning 3 Conditioned priority functioning 4 Parallel functioning depending on climatic conditions 5 Priority functioning with intermediate heating 6 Priority separated activation 7 External functioning
08	Storage tank anti-drain function	OFF	OFF - disactivated ON - activated
09	D.h.w./delivery temperatures $\Delta T$	20 K	0 ... 50 K;

PARAMETER	Description	Regulation	Setting range / Parameters
10	D.h.w. thermostat hysteresis	5 K	2 ... 20 K; Value simmetric to d.h.w. set-point
11	D. h. w. post-circulation	1 Min	0 ... 60 Min
12	Recirculating pump timer	AUTO	AUTO - Active d.h.w. time-program 1 - P1, direct heating circuit 2 - P2, direct heating circuit 3 - P3, direct heating circuit 4 - P1, mixed heating circuit 1 5 - P2, mixed heating circuit 1 6 - P3, mixed heating circuit 1 7 - P1, mixed heating circuit 2 8 - P2, mixed heating circuit 2 9 - P3, mixed heating circuit 2 10 - P1, domestic hot water circuit 11 - P2, domestic hot water circuit 12 - P3, domestic hot water circuit
13	Recirculating pump economy interval (pause)	5 Min	0 Min ... value of parameter 14; interval in wich the pump doesn't work
14	Recirculating pump economy interval (period lenght)	20 Min	1 .. 60 Min (pause + period)

## Configuration level for direct / mixed 1 / mixed 2 heating circuits.

These sections include all the necessary parameters to program the direct / mixed heating circuits.

PARAMETER	Description	Regulation DC	Regulation MC 1	Regulation MC 2	Setting range / Parameters
REDUCED HEATING	Reduced/eco functioning mode	ECO	ECO	ECO	ECO - functioning with stop RID - functioning with reduced temp.
HEATING SYSTEM	Type of heating system	1.3	1.1	1.1	1,00 ... 10,00 (Radiators, Underfloor, etc ...)
03	Room temperature sensor activation	OFF	OFF	OFF	OFF 1 Room sensor activated 2 Room sensor activated, control locked 3 Only for visualization
04	Influence of room sensor over delivery temperature	OFF	OFF	OFF	OFF 10 ... 500 % influence RC remote control active
05	Automatic heating curve adjustment	OFF	OFF	OFF	OFF, ON
06	Central heating pre-ignition	OFF	OFF	OFF	OFF, 1 ... 16 h
07	Heating circuit restriction	OFF	OFF	OFF	OFF, 0,5 ... 40 K
08	Room anti-freeze temperature	5 °C	5 °C	5 °C	5 ... 30 °C
09	Room thermostat function activation	OFF	OFF	OFF	OFF, 0,5 ... 5 K (differential)
11	Constant temperature nominal value	20°C	20°C	20°C	10 .. 95°C only for fixed regulation (KR)
12	Min. delivery temperature	20 °C	20 °C	20 °C	10 °C ... max. temperature (parameter 13)

PARAMETER	Description	Regulation DC	Regulation MC 1	Regulation MC 2	Setting range / Parameters
13	Max. delivery temperature	85 °C	45 °C	45 °C	Min. temperature (parameter 12) ... 95 °C
14	Circuit delivery temperature increase	0	0	0	-5 ... 20 K
15	Circuit post-circulation	3	3	3	0 ... 60 Min
16	Mortar bed heating working	OFF	OFF	OFF	OFF 1 Heating working 2 Working with setted profile 3 Heating working + setted profile



## Boiler configuration level.

The parameters of this section are referred to heat generator types and to their specific characteristics.

PARAMETER	Description	Regulation	Setting range / Parameters
01	Heat generator type	5	OFF no heat generators 1 1 step gas generator 2 2 steps gas generator 3 two 1 step gas generators 4 Variable burner 5 condensing
03	Min. heat generator temperature	20 °C	5 °C ... Max. temperature
04	Max. heat generator temperature	85 °C	Min. temperature ... 95 °C
17	Max. flue gas temperature	150 °C	50 ... 500 °C
25	Max. external temperature lock	OFF	OFF, -20 ... 30 °C
26	Initial delivery temperature increase for standard loading	0	0 ... 60 K
29	Forced heat dissipation	OFF	OFF 1 Into the d.h.w. storage tank 2 Into the heating circuits 3 Into the buffer

**Cascade configuration level.**

The parameters included in this section refer to the connection of boilers in cascade. The visualization is possible only when more boilers are controlled by the regulator.

PARAMETER	Description	Regulation	Setting range / Parameters
01	Common delivery temperature differential	10	0,5 ... 30 K
02	Start delay	0	0 ... 200 Min
03	Stop delay	0	0 ... 60 Min
04	Boilers switching-on heat output	65	10 ... 100 % Nominal heat output
05	Boiler sequence inversal	OFF	OFF, 1 ... 240 h
06	Primary stage	1	1 ... n (stages number)
07	Peak boiler from address	OFF	3 ... n (stages number)
08	Peak boilers change with standard	OFF	OFF, ON

**BUS data configuration level.**

PARAMETER	Description	Regulation	Setting range / Parameters
01	Regulator BUS address	10	10, 20, 30, 40, 50
02	Configuration of direct circuit remote control	2	1 Parameters modification of all circuits 2 Parameters modification of Direct Circuit only
03	Configuration of mixed circuit 1 remote control	2	1 Parameters modification of all circuits 2 Parameters modification of Mixed Circuit 1 only
04	Configuration of mixed circuit 2 remote control	2	1 Parameters modification of all circuits 2 Parameters modification of Mixed Circuit 2 only

## Solar configuration level (..VV..)

The parameters included in this section refer to the special adjustments for solar features. The enabling is possible only if the relative activation is present into the hydraulic section.

PARAMETER	Description	Regulation	Setting range / Parameters
01	Hysteresis ON	10	(Hysteresis OFF +3 K) ... 30 K
02	Hysteresis OFF	5	2 K ... (Hysteresis ON - 3K)
03	Min. run time solar pump	3	0 ... 60 Min
04	Solar collector max. temperature	120	70 ... 250 °C
05	Solar tank max. limit	75	20 ... 110 °C
06	Solar operational mode	1	1 Priority working 2 Parallel working 3 Priority for D.h.w 4 Priority for buffer
07	Inhibition heat generation alternance (only with parameter 06=1)	OFF	OFF, 0,5 ... 24 h
08	Change priority/ parallel mode	OFF	OFF, (only with par. 06=1 and par. 07=ON) 1 ... 30 K
09	Solar energy balance	OFF	OFF No thermal balance 1 Thermal balance with flow rate calculation 2 Thermal balance through pulses inlet
SOLAR RESET	Reset energy balance		RESET pressing the knob
11	Volumetric flow rate	0,0	0,0 ... 30 l/min o l/pulse (only for solar energy balance active)
12	Density HTM	1,05	0,8 ... 1,2 kg/l (only for solar energy balance active)
13	Heat capacity HTM	3,6	3,0 ... 5,0 kJ/kgK (only for solar energy balance active)

PARAMETER	Description	Regulation	Setting range / Parameters
14	Final switch-off temperature	150	Solar manifold max. temperature. .... OFF, 90 ... 210 °C
15	Commutation delay	OFF	OFF, 1 ... 60 min
16	Commutation temperature for run valve	75	20 ... 110 °C

## BUFFER configuration level (..VV..)

The parameters included in this section refer to the special adjustments for BUFFER adjustment. The enabling is possible only if the relative activation is present into the hydraulic section.

PARAMETER	Description	Regulation	Setting range / Parameters
01	Minimum temperature	20	5 °C ... BUFFER maximum temperature
02	Maximum temperature	80	Minimum temperature... 95°C
03	Boiler temperature increase according to the SET	8	-10 ... 80 K
04	Hysteresis OFF	2	1 ... 70 K
05	Forced deviation for heat dissipation	OFF	OFF      disactivated 1          into the d.h.w. tank 2          into the heating circuits
06	Hysteresis ON post circ.	10	(Hysteresis OFF +2 K) ... 30 K
07	Hysteresis OFF post circ.	5	1 K ... (Hysteresis ON - 2K)
08	Circuits pumps anti-starting working	ON	OFF      no anti-starting working ON        anti-starting working activated
09	BUFFER anti-discharged working.	ON	OFF      no anti-unloading ON        anti-discharged activated
10	BUFFER working mode	1	1          heating charge control and D.h.w. 2          heating circuit charge control without domestic water 3          heating circuit discharged control and domestic water 4          heating circuit discharged control without domestic water 5          supply charge control with domestic water commutation 6          discharged control to the heating generator.

## TECHNICAL DATA.

### Cascade and zones regulator.

Mains connection voltage:	230 V~ +6/-10%
Nominal frequency:	50 - 60 Hz
Power consumption:	5,8 VA max.
Bus interface:	T2B 12V/150 mA
Ambient temperature:	0...50 °C
Storage temperature:	-25...60 °C
Electrical protection:	IP 30
Protection class acc. to EN 60730:	II
Protection class acc. to EN 60529:	III
Software-class:	A
EMV-protection:	EN 55014 (1993)
Resistance to disturbances:	EN 55104 (1995)
EC conformity:	89/336/EU
Casing dimensions (WxHxD):	Standard regulator: 144 x 96 x 75 mm
Casing material:	ABS, antistatic, hardly inflammable
Nominal current:	6 A
Mains fuse:	6,3 A
Output relay max. current load:	2 A

## **Zone manager.**

Main connection voltage:	through data bus (safety low tension acc. to EN 60730)
Power consumption:	300 mW
Bus interface:	T2B
Ambient temperature:	0...50 °C
Storage temperature:	-25...60 °C
Protection class acc. to EN 60529:	IP 20
Protection class acc. to EN 60730:	III
According to:	EN 60 730
Casing dimensions:	90 x 138 x 28 mm (WxHxD)
Casing material:	ABS, antistatic
Recommended connection cable:	J-Y(St)Y 2x2x0,6
Max. lenght:	50 m
Data memory and timer duration:	min. 5 years
Internal clock precision:	± 2 s/day
Display:	Alphanumeric display with symbols
Weight:	150 g

**Sensors resistance values depending on the temperature.**Type: kty 2K $\Omega$  at 25°C

T (°C)	R (k $\Omega$ )
10	1,783
12	1,812
14	1,840
16	1,869
18	1,898
20	1,928
25	2,002
30	2,078
35	2,155
40	2,234
45	2,314
50	2,395
55	2,478
60	2,563
65	2,648
70	2,735
75	2,824
80	2,914
85	3,005
90	3,098
95	3,192
100	3,287









Code 1.026649 Rev. 15.027407/000 - 08/08



**iMMERGAS**

Certificate enterprise ISO 9001

[www.immergas.com](http://www.immergas.com)

Immergas S.p.A. • 42041 Brescello (RE) - I • Tel. 0522.689011 • Fax 0522.689102