

# MAGIS M4/30

Block heat pumps  
Control Panel

**IE**

**Instructions and  
recommendations**

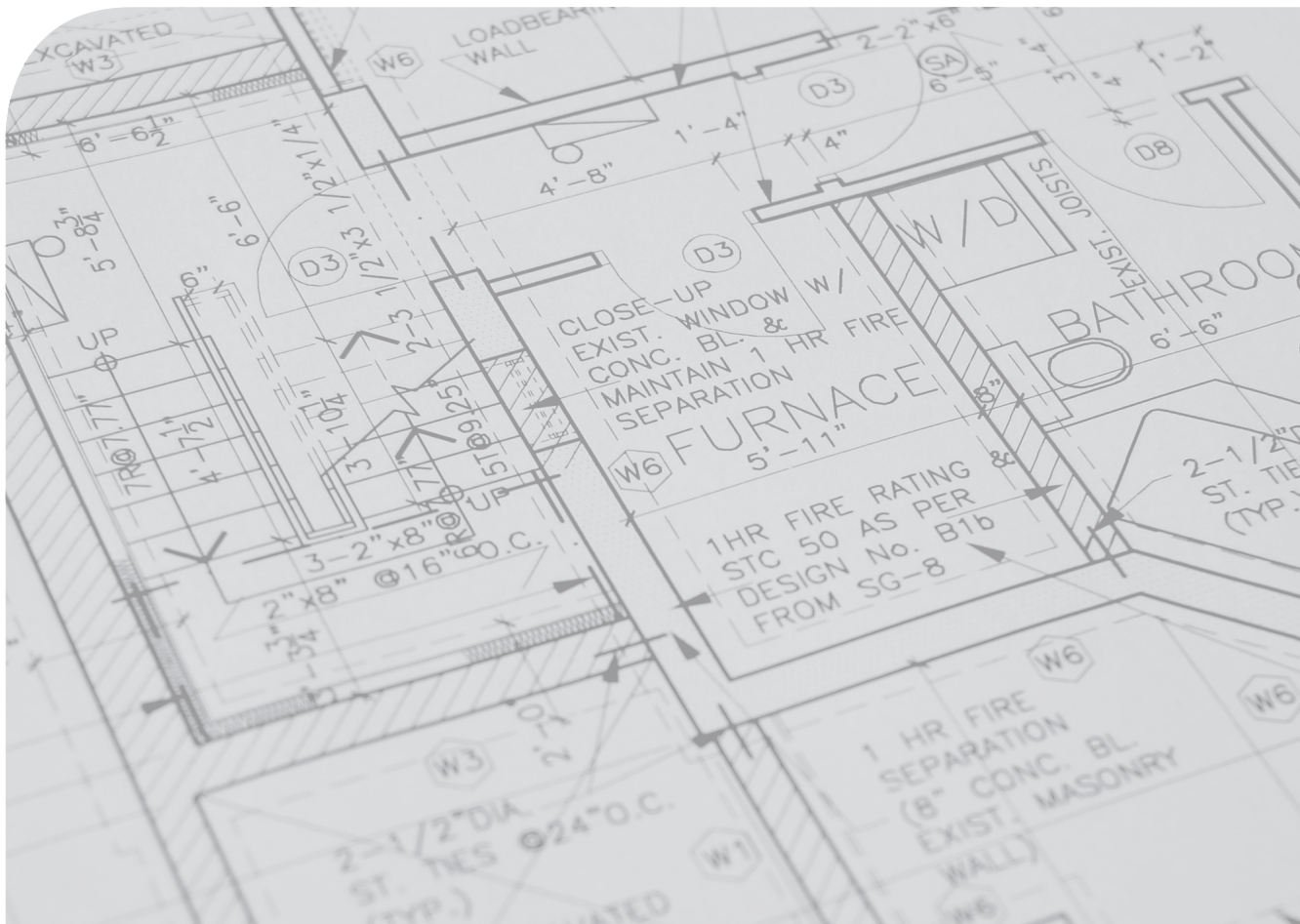

## INDEX

Dear Customer.....	3
List of abbreviations used.....	4
General Recommendations.....	5
Safety symbols used.....	6
Personal protective equipment .....	6
<b>1 General safety warnings. ....</b>	<b>7</b>
1.1 For the user.....	7
<b>2 Presentation of Control panel.....</b>	<b>8</b>
2.1 Appearance of the Control panel.....	8
2.2 Status icons.....	9
<b>3 Using home pages.....</b>	<b>11</b>
<b>4 Menu structure. ....</b>	<b>15</b>
4.1 About the menu structure. ....	15
4.2 Access to the menu structure. ....	15
4.3 How to navigate in the menu structure. ....	15
<b>5 Basic use.....</b>	<b>16</b>
5.1 Screen unlock.....	16
5.2 Switching controls on/off.....	17
5.3 Adjusting the temperature.....	21
5.4 Adjusting space operation mode.....	22
<b>6 Operation. ....</b>	<b>24</b>
6.1 Operation mode.....	24
6.2 Preset temperature.....	24
6.3 Domestic Hot Water (DHW).....	29
6.4 Programming.....	33
6.5 Options.....	38
6.6 Child lock.....	42
6.7 Technical information.....	44
6.8 Operation parameters.....	46
6.9 For Serviceman.....	47
6.10 Shows SN.....	48
<b>7 Menu structure: overview. ....</b>	<b>49</b>



## Dear Customer

*Congratulations for having chosen a top-quality Immergas product, able to assure well-being and safety for a long period of time. As an Immergas customer you can also count on a Qualified Authorised After-Sales Technical Assistance Centre, prepared and updated to guarantee the constant efficiency of your products. Read the following pages carefully: you will be able to draw useful tips on the proper use of the device, compliance with which will confirm your satisfaction with the Immergas product.*

*For assistance and routine maintenance, contact Authorised Technical Service Centres: they have original spare parts and are specifically trained directly by the manufacturer.*

The company **IMMERGAS S.p.A.**, with registered office in via Cisa Ligure 95 42041 Brescello (RE), declares that the design, manufacturing and after-sales assistance processes comply with the requirements of standard **UNI EN ISO 9001:2015**.

For further details on the product CE marking, request a copy of the Declaration of Conformity from the manufacturer, specifying the appliance model and the language of the country.

The manufacturer declines all liability due to printing or transcription errors, reserving the right to make any modifications to its technical and commercial documents without forewarning.



## LIST OF ABBREVIATIONS USED

The following is the key of the abbreviations used in this document.

<i>ACS</i>	Domestic hot water
<i>CO<sub>2</sub></i>	Carbon dioxide
<i>CVC</i>	Fan coil
<i>DHW</i>	Domestic hot water
<i>etc.</i>	Etc.
<i>FCU</i>	Fan coil
<i>Fig.</i>	Figure
<i>FHL</i>	Floor heating circuit
<i>IBH</i>	Indoor unit backup heater
<i>MFA</i>	Maximum fuse amp.
<i>MOP</i>	Maximum overcurrent protection
<i>Max.</i>	Maximum
<i>Min.</i>	Minimum
<i>Nom.</i>	Rated
<i>Par.</i>	Paragraph
<i>RAD</i>	Radiator
<i>Ta</i>	Room temperature
<i>TBH</i>	DHW storage tank backup heater





## GENERAL RECOMMENDATIONS

- The instruction booklet is an integral and essential part of the product and must be given to the new user in the case of transfer or succession of ownership.
- It must be stored with care and consulted carefully, as all of the warnings provide important safety indications for installation, use and maintenance stages.
- In compliance with the legislation in force, the systems must be designed by qualified professionals, within the dimensional limits established by the Law. Installation and maintenance must be performed in compliance with the regulations in force, according to the manufacturer's instructions and by professionally qualified staff, meaning staff with specific technical skills in the plant sector, as provided for by Law.
- Improper installation or assembly of the Immergas device and/or components, accessories, kits and devices can cause unexpected problems for people, animals and objects. Read the instructions provided with the product carefully to ensure proper installation.
- This instructions manual provides technical information for installing Immergas products. As for the other issues related to the installation of products (e.g. safety at the workplace, environmental protection, accident prevention), it is necessary to comply with the provisions of the standards in force and the principles of good practice.
- All Immergas products are protected with suitable transport packaging.
- The material must be stored in a dry place protected from the weather.
- Damaged products must not be installed.
- Maintenance must be carried out by skilled technical staff. For example, the Authorised Service Centre that represents a guarantee of qualifications and professionalism.
- The appliance must only be destined for the use for which it has been expressly declared. Any other use will be considered improper and therefore potentially dangerous.
- If errors occur during installation, operation and maintenance, due to non-compliance with technical laws in force, standards or instructions contained in this booklet (or however supplied by the manufacturer), the manufacturer is excluded from any contractual and extra-contractual liability for any damages and the device warranty is invalidated.
- In the event of malfunctions, faults or incorrect operation, turn the appliance off and contact an authorised company (e.g. the Authorised Technical Assistance Centre, which has specifically trained staff and original spare parts). Do not attempt to modify or repair the appliance alone.
- For further information regarding legislative and statutory provisions relative to the installation of heat pumps, consult the Immergas site at the following address: [www.immergas.com](http://www.immergas.com)
- This manual provides a detailed explanation on the precautions to be taken during use.
- Read this manual carefully before using the wall-mounted control unit to guarantee its proper operation.
- After you have read this manual, keep it for future consultation.



## SAFETY SYMBOLS USED



### GENERIC HAZARD

Strictly follow all of the indications next to the pictogram. Failure to follow the indications can generate hazard situations resulting in possible harm to the health of the operator and user in general, and/or property damage.



### ELECTRICAL HAZARD

Strictly follow all of the indications next to the pictogram. The symbol indicates the appliance's electrical components or, in this manual, identifies actions that can cause an electrical hazard.



### WARNING FOR INSTALLER

Read the instruction booklet carefully before installing the product.



### WARNINGS

Strictly follow all of the indications next to the pictogram. Failure to follow the indications can generate hazard situations resulting in possible minor injuries to the health of both the operator and the user in general, and/or slight material damage.



### ATTENTION

Read and understand the instructions of the appliance before carrying out any operation, carefully following the instructions given. Failure to observe the instructions may result in malfunction of the unit.



### INFORMATION

Indicates useful tips or additional information.



### EARTH TERMINAL CONNECTION

The symbol identifies the appliance's earth terminal connection point.



### DISPOSAL WARNING

The user must not dispose of the appliance at the end of its service life as municipal waste, but send it to appropriate collection centres.

## PERSONAL PROTECTIVE EQUIPMENT



### SAFETY GLOVES



### EYE PROTECTION



### SAFETY FOOTWEAR



# 1 GENERAL SAFETY WARNINGS.

## 1.1 FOR THE USER.

- If you are not sure how to operate the unit, contact your installer.
- This appliance must not be used by persons (including children) without adequate physical, sensory or mental capacities or without specific experience and knowledge, unless they are supervised or have been instructed as to how to use the appliance by a person responsible for their safety. Supervise children and make sure they do not play with the device.



Do NOT wash the unit as this could result in electrocution or fire.

---

- The devices are marked with the following symbol:



**This symbol indicates that electric and electronic products must not be disposed of together with household unsorted waste.**

**Do NOT try to disassemble the system on your own: only a qualified installer may disassemble the device and process the refrigerant, oil and other components, in compliance with standards in force.**

**The units must be processed at a specific waste disposal facility so that the materials can be re-used, recycled and recovered.**

**Making sure that the product is disposed of correctly shall avoid possible negative consequences for the environment and human health.**

**For further information, contact your installer or local authorities.**

---

- Install in a place where there is no radiation present.



## 2 PRESENTATION OF CONTROL PANEL.

### 2.1 APPEARANCE OF THE CONTROL PANEL.

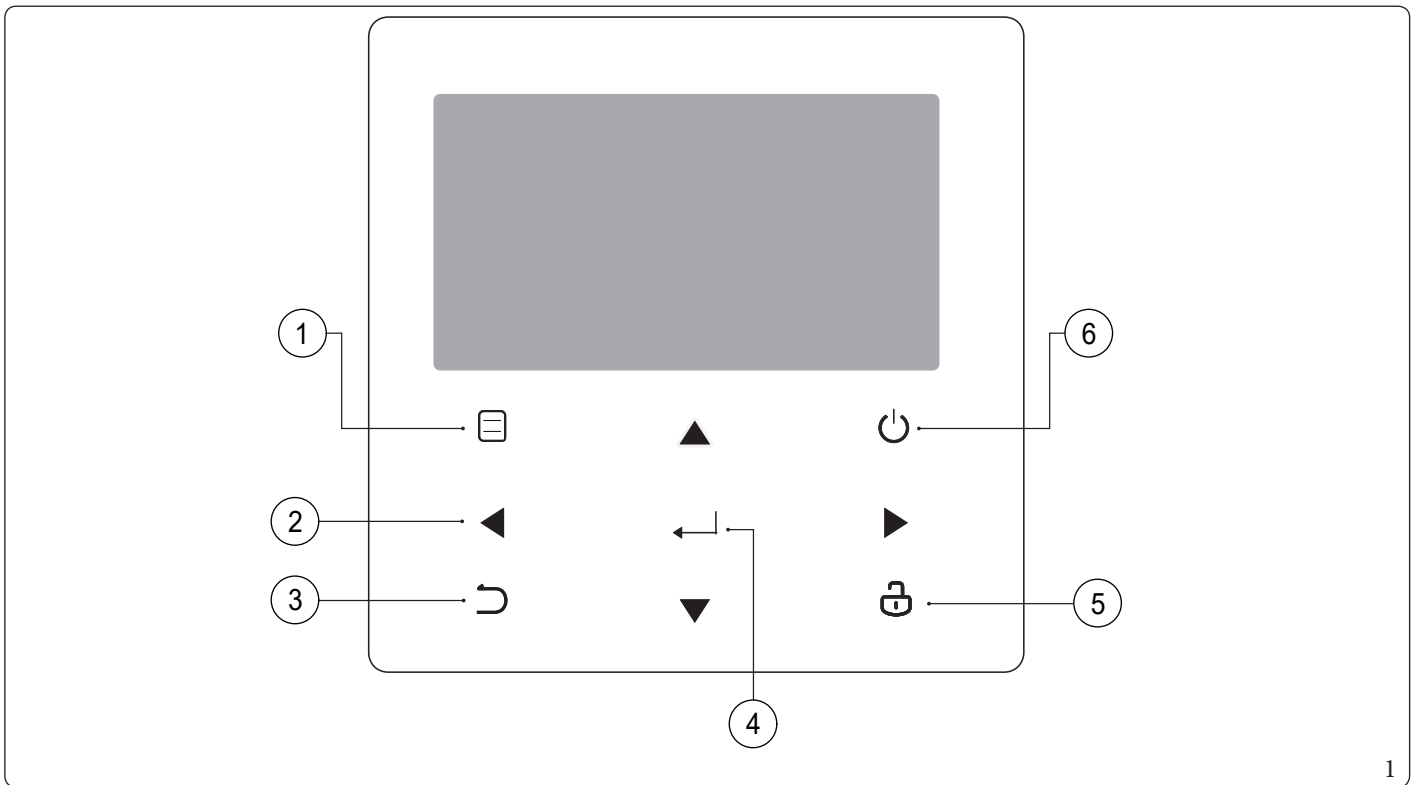

Reference	Icon	Function
1		Enter the menu structure from the home page.
2		Move the cursor on the display. Navigate in the menu structure. Adjust the settings.
3		Go back to higher level.
4		Go to the next step when programming a schedule in the menu structure. Confirm a selection. Enter a submenu in the menu structure.
5		Long press to unlock/lock the control panel. Release/block some functions like "DHW TEMP.ADJUST".
6		Activate or deactivate the room operation mode or "13.2 DHW MODE". Enable or disable the function in the menu structure.





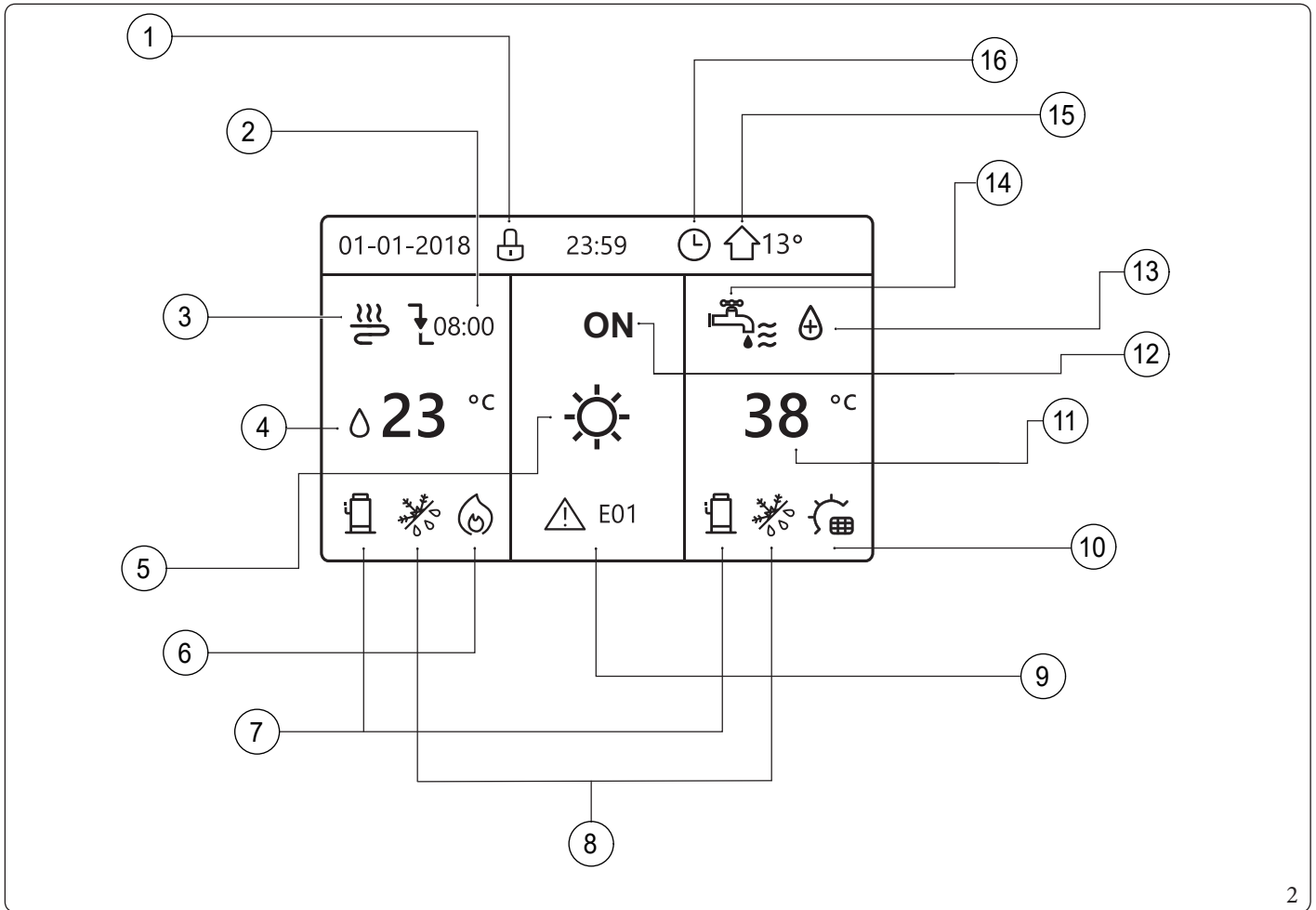























## 2.2 STATUSICONS.



2



Reference	Icon	Description
1		Lock icon
2		Desired temperature does not change
		Desired temperature decreases
		Desired temperature increases
3		Fan coil
		Radiator
		Floor heating
4	23 °C	Desired water flow temperature
	23,5 °C	Desired room temperature
5		Heating Mode
		Cooling Mode
		Auto mode
6		Additional heating source (not used)
		Heating source (Backup Heater IBH)



Reference	Icon	Description		
7		Compressor on		
8		Anti-freeze mode activated		
		Defrost mode activated		
		Holiday away/home activated		
		Silent mode activated		
		ECO mode activated		
9		Error or protection icon		
		Pump on		
		Smart grid: Free electricity		
		Smart grid: Peak end electricity		
		Smart grid: Peak electricity		
10		Additional heating source (not used)		
		Photovoltaic contact activated		
		Storage tank heater on		
11	<b>38 °C</b>	Domestic hot water Storage tank temperature		
12	OFF ON	Turn Off/ On		
13		Disinfect function activated		
14		Domestic hot water		
15		External room temperature		
16		Weekly schedule icon		
		Timer icon		
	<b>Fancoil</b>	<b>Radiator</b>	<b>Floor heating</b>	<b>Domestic hot water</b>
ON				
OFF				



### 3 USING HOME PAGES.

When the control panel is switched on, the language selection page is displayed. Choose the desired language and then press  to view the home pages. If you do not press  within 60 seconds, the system will set the currently selected language:

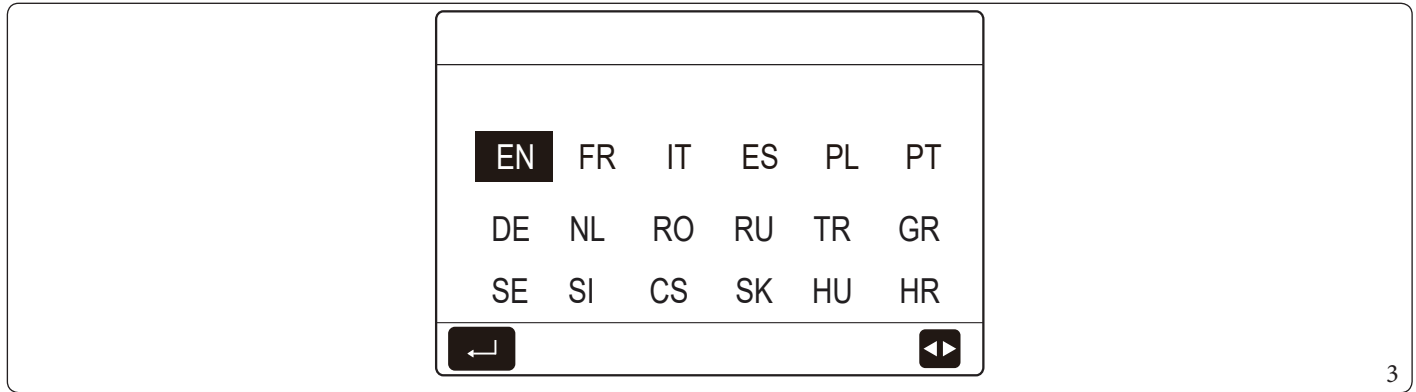

The home pages can be used to read and adjust settings intended for daily use. The settings displayed and that can be set on the home pages are described in the relative sections. The following home pages can be displayed depending on the system layout:

- Desired water flow temperature;
- Desired room temperature;
- DHW storage tank temperature.

#### Home page 1.

If "5.1 WATER FLOW TEMP." is set at "YES" and "5.2 ROOM TEMP." is set at "NON" (see "FOR SERVICEMAN" > "5. TEMP. TYPE SETTING" in the Use and Installation Booklet), the system will also include the floor and domestic hot water heating function. The home page will appear (Fig. 4):

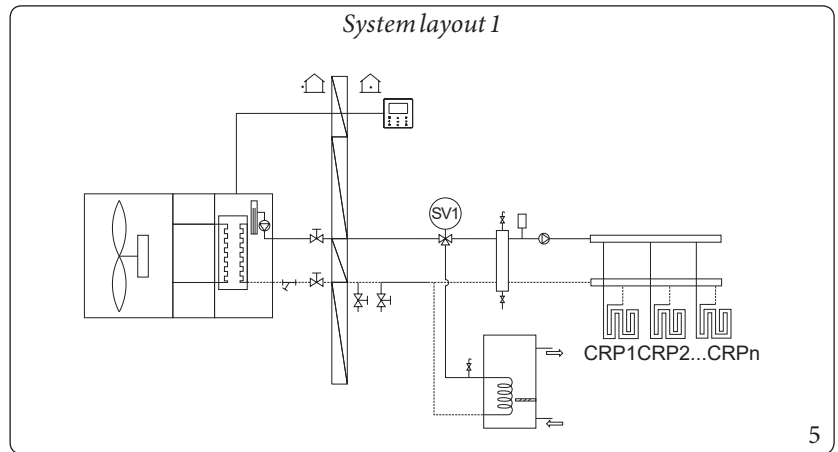
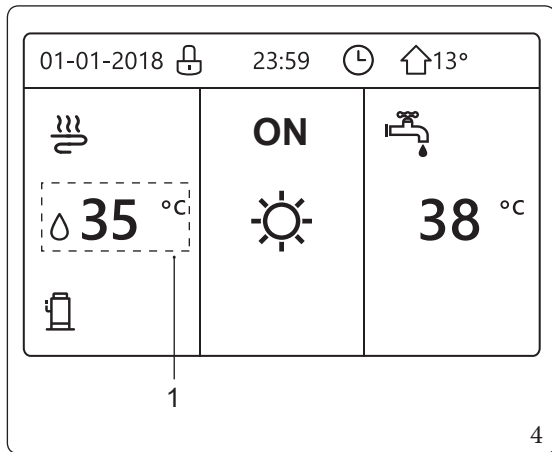

Key (Fig. 4):

- 1 - Desired water flow temperature



All the images in the manual have been inserted for illustrative purposes. Therefore there could be differences compared to the pages that actually appear on the screen.



## Home page 2.

If "5.1 WATER FLOW TEMP." is set at "NON" and "5.2 ROOM TEMP." is set at "YES" (see "FOR SERVICEMAN" > "5. TEMP. TYPE SETTING" in the Use and Installation Booklet), the system will also include the floor and domestic hot water heating function. The home page will appear (Fig. 6):

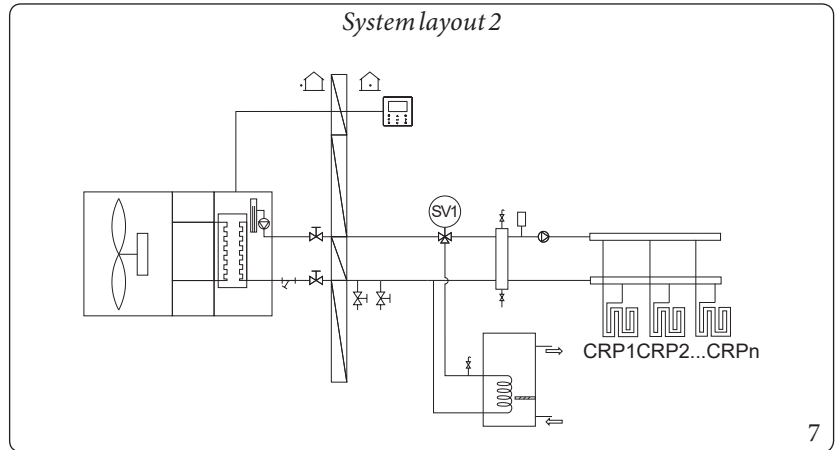
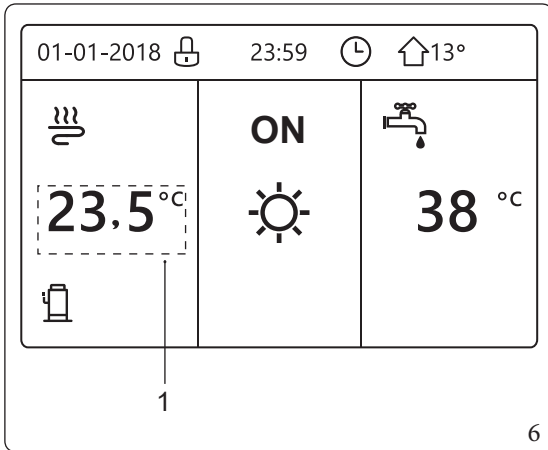

Key (Fig. 6):

1 - Desired room temperature



The wall-mounted control panel should be installed in the floor heating room to be able to control the room temperature.

### Home page 3.

If "13.2 DHW MODE" is set at "NON" (see "FOR SERVICEMAN" > "1. DHW MODE SETTING" in the Use and Installation Booklet") and if "5.1 WATER FLOW TEMP." is set at "YES", "5.2 ROOM TEMP." is set at "YES" (see "FOR SERVICEMAN" > "5. TEMP. TYPE SETTING" in the Use and Installation Booklet").

There will be a main page and an additional page. The system also has the function including floor heating and space heating for fan coil. The home page will appear (Fig. 8):

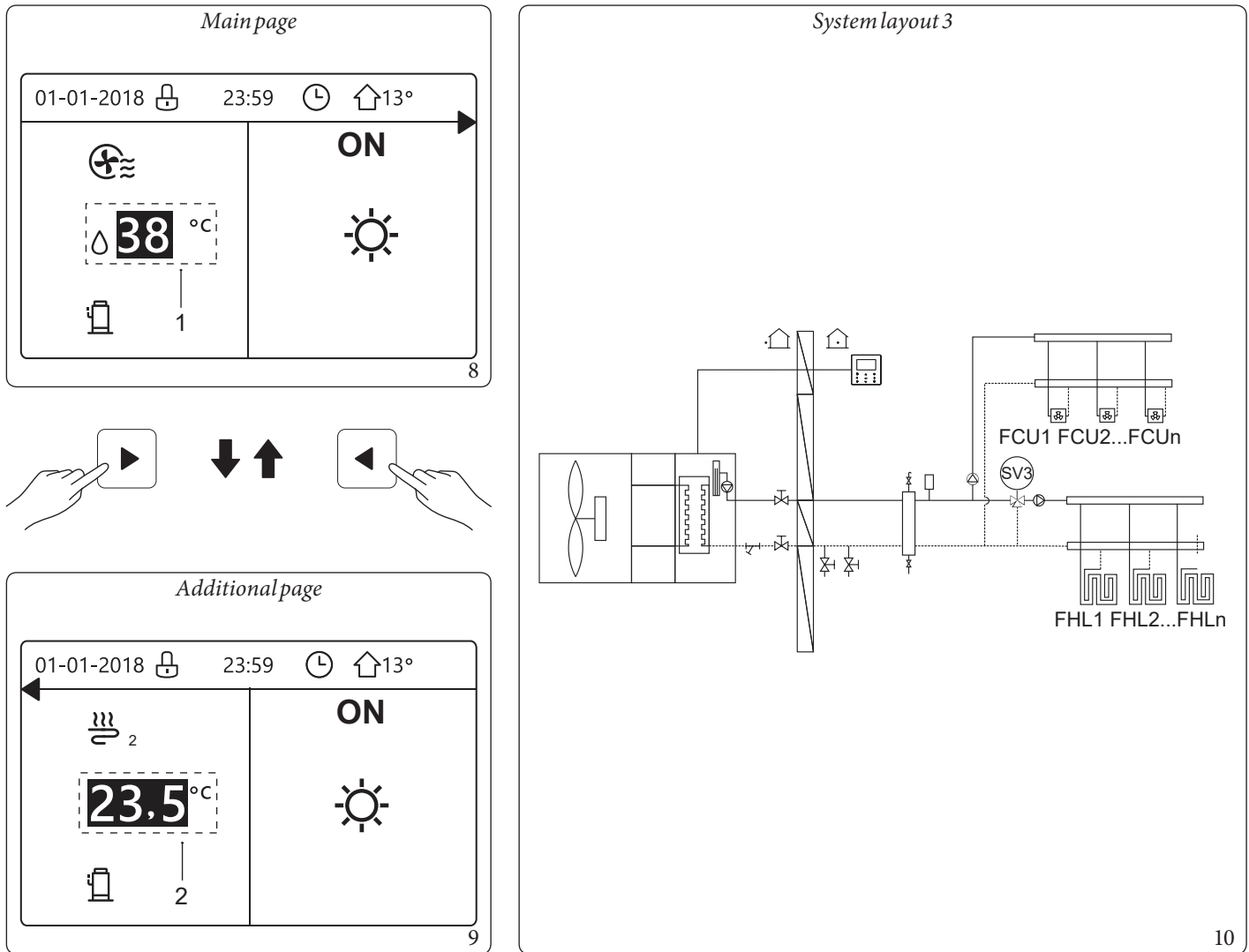

Key (Fig. 8-9):

- 1 - Zone 1 desired water flow temperature
- 2 - Zone 2 desired room temperature



### Home page 4.

If "6. ROOM THERMOSTAT" is set at "DOUBLE ZONE" or "DOUBLE ZONE" is set at "YES", there will be a main page and an additional page. The system also has the function including floor heating, space heating for fan coil and domestic hot water.

The home page will appear (Fig. 11):

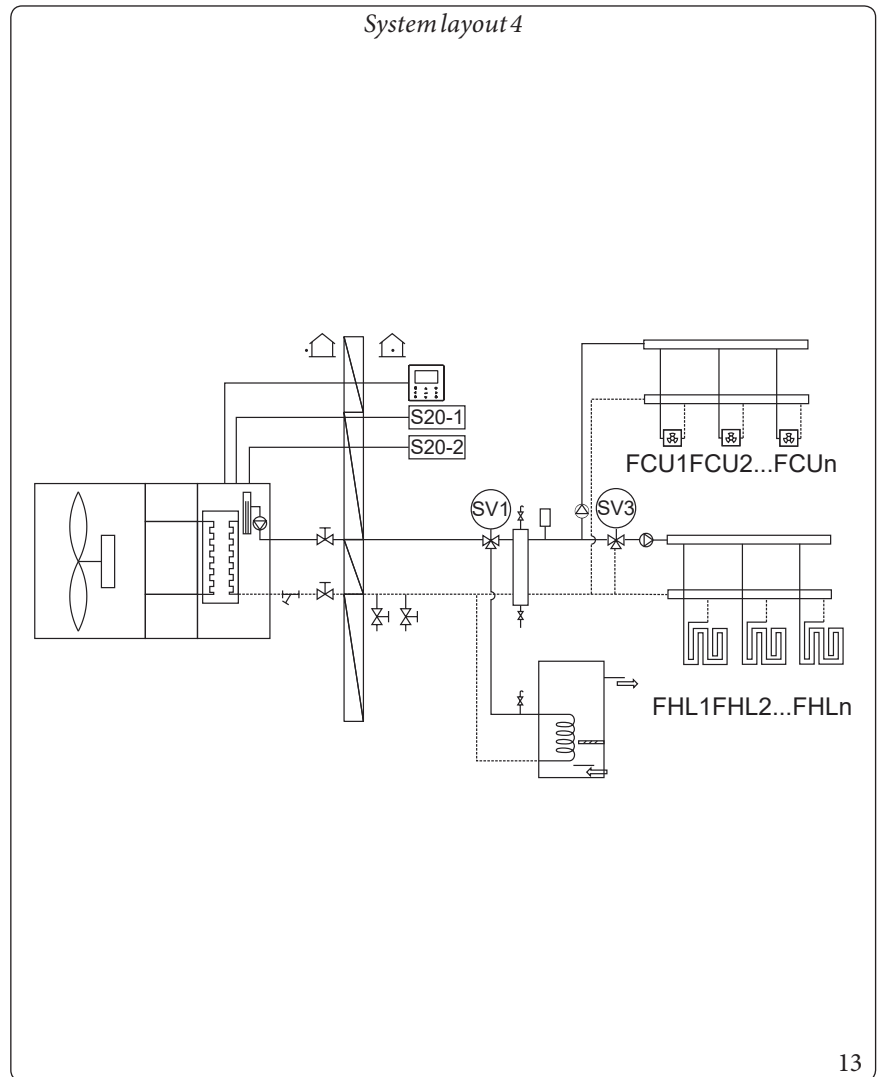
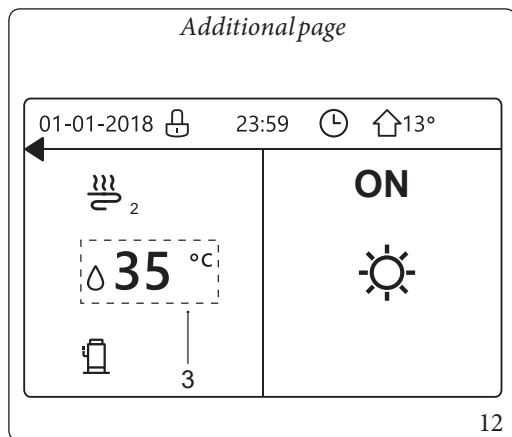
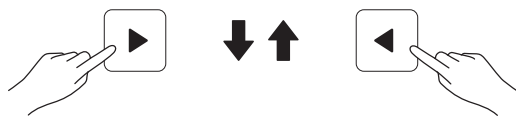
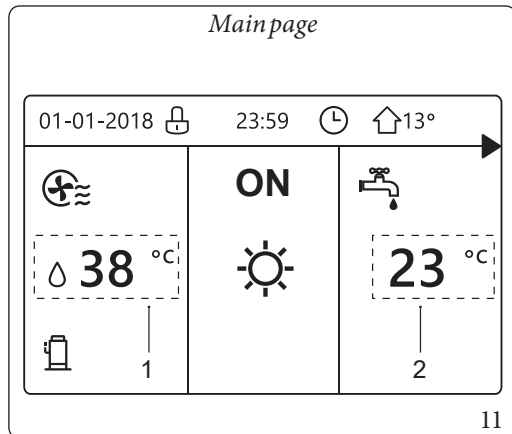

Key (Fig. 11 - 12 - 13):

- 1 - Zone 1 desired water flow temperature
- 2 - DHW tank real temperature
- 3 - Zone 2 desired room temperature
- S20-1 - Zone 1 room thermostat
- S20-2 - Zone 2 room thermostat



# 4 MENU STRUCTURE.

## 4.1 ABOUT THE MENU STRUCTURE.

The menu structures can be used to read and adjust settings NOT intended for daily use.

The settings displayed and that can be set in the menu structures are described in the relative sections.

For an overview of the menu structure, see chapter 7 “Menu structure: overview”.

## 4.2 ACCESS TO THE MENU STRUCTURE.

From a home page, press . This will display the menu structure:

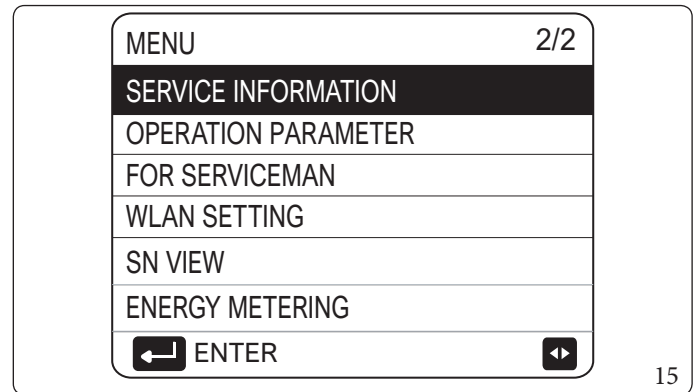
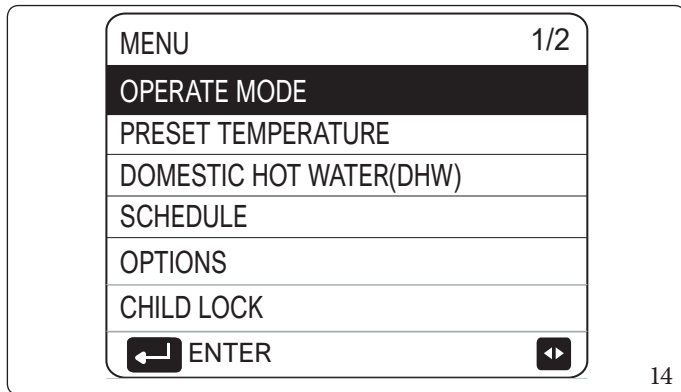

## 4.3 HOW TO NAVIGATE IN THE MENU STRUCTURE.

Use “▼” and “▲” to scroll.





# 5 BASIC USE.

## 5.1 SCREEN UNLOCK.

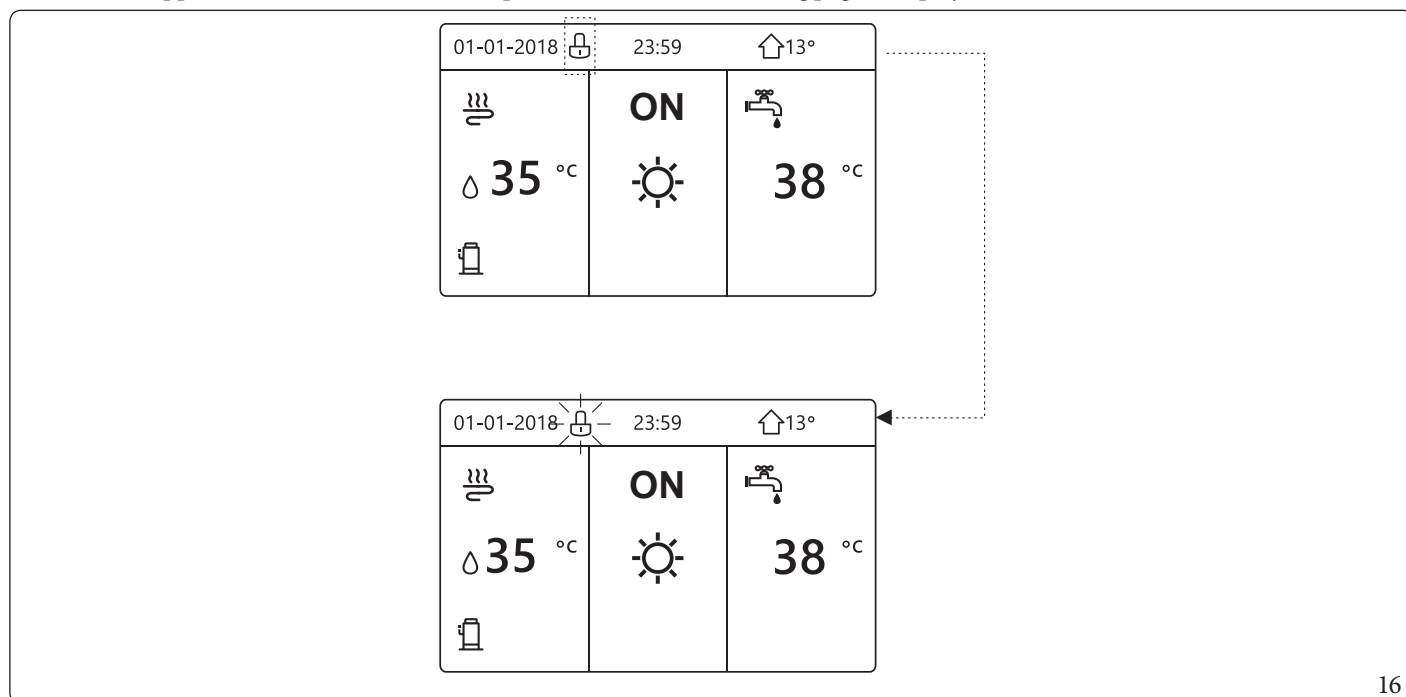
If the icon  appears on the screen, the control panel is locked. The following page is displayed:



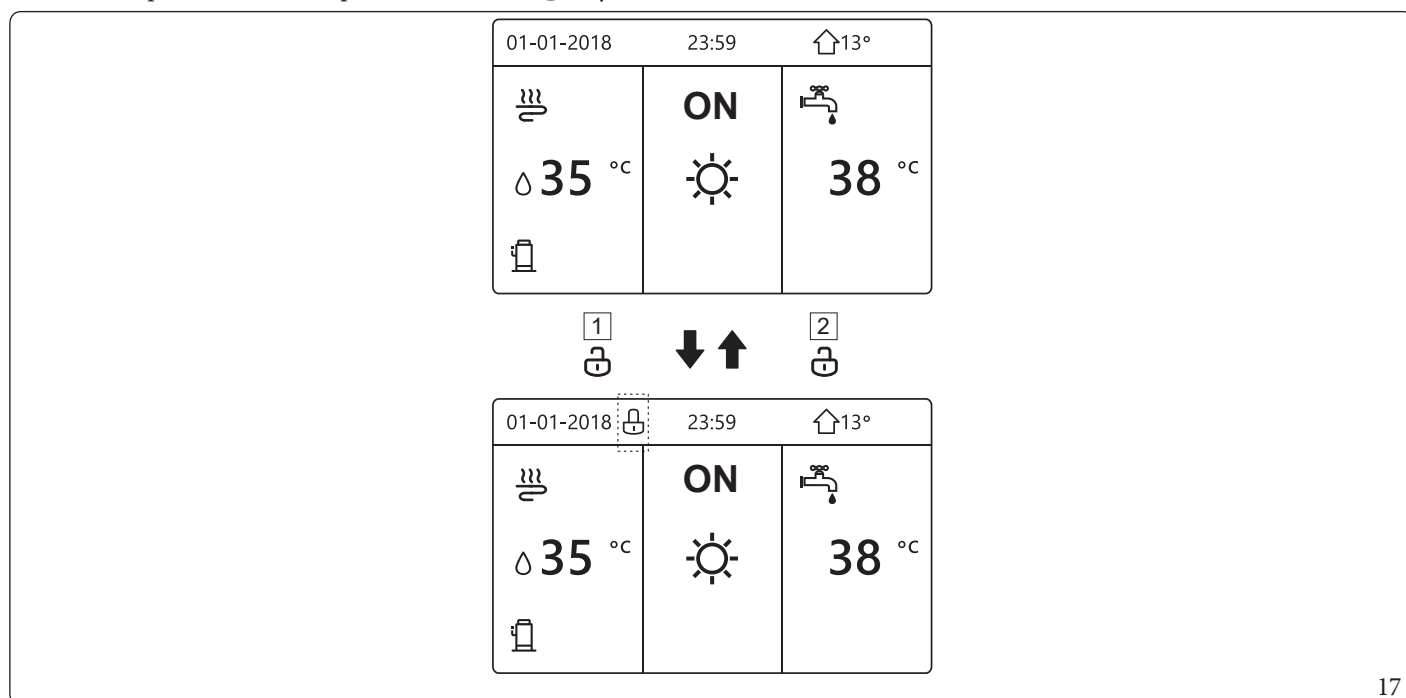

Press any key, the icon  flashes. Press and hold the  key. The icon  will disappear, making it possible to control the panel. The control panel will lock if no operations are performed for much time (approximately 120 seconds): the setting can be adjusted on the panel, see paragraph 6.7 "Technical information."

If the control panel is unlocked, press and hold the  key to lock it.



Key (Fig. 17):

- 1 - Press and hold 
- 2 - Press and hold 







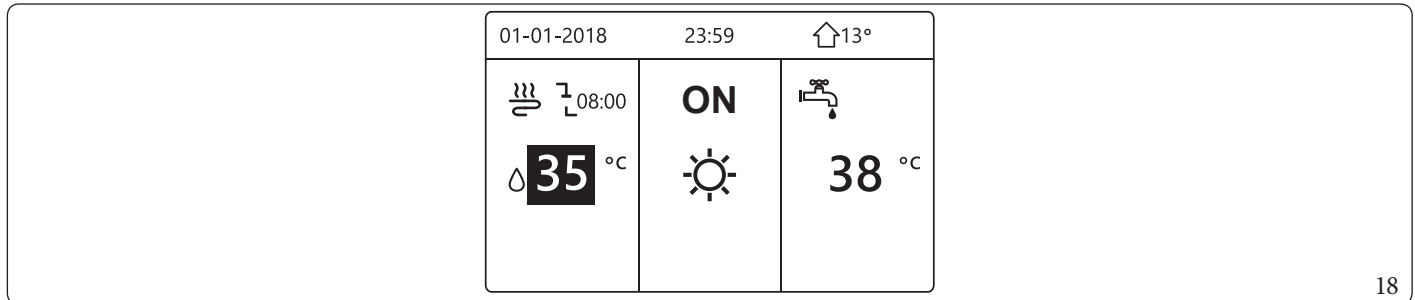

## 5.2 SWITCHING CONTROLS ON/OFF.

Use the control panel of the unit to switch space heating or cooling on or off.

- You may switch the unit on/off from the control panel if "6. ROOM THERMOSTAT" is set at "NON" (see "6. ROOM THERMOSTAT" in the Use and Installation Booklet).
- Press "◀" and "▶" on the home page, the black cursor will appear:



- 1) When the cursor is on the temperature on the space operation mode side (which includes "HEATING" mode , "COOLING" mode  and "AUTO" mode , press the  key to activate/deactivate space heating or cooling.

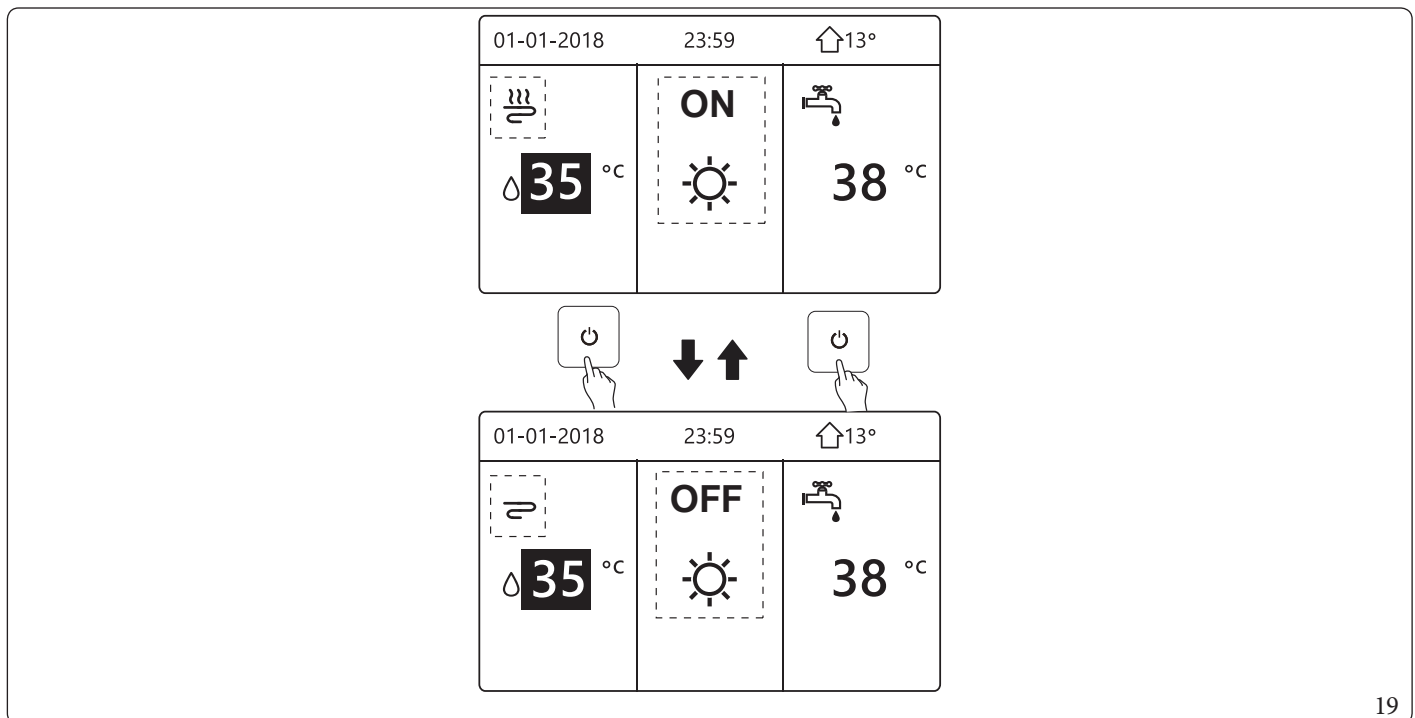

If DHW TYPE is set at NO, the following pages will appear:

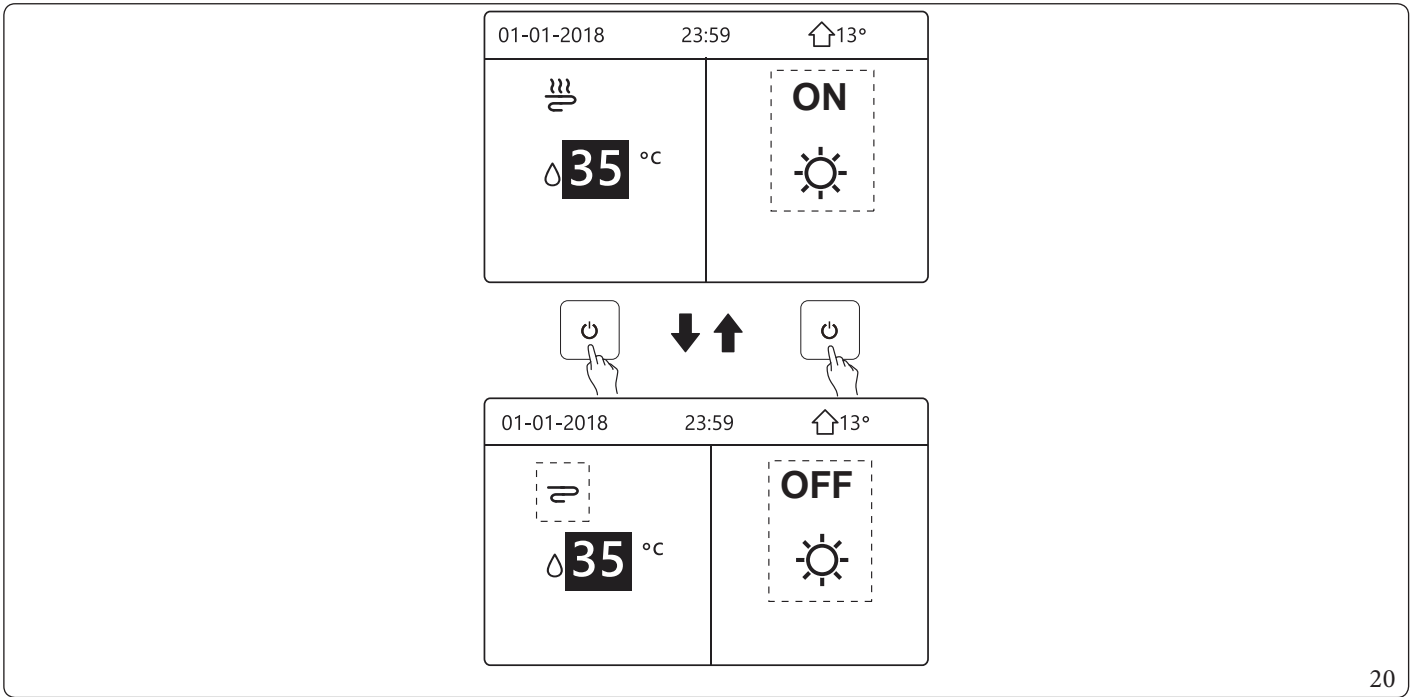

20

If "5. TEMP. TYPE SETTING" is set at "5.2 ROOM TEMP.", the following pages will appear:

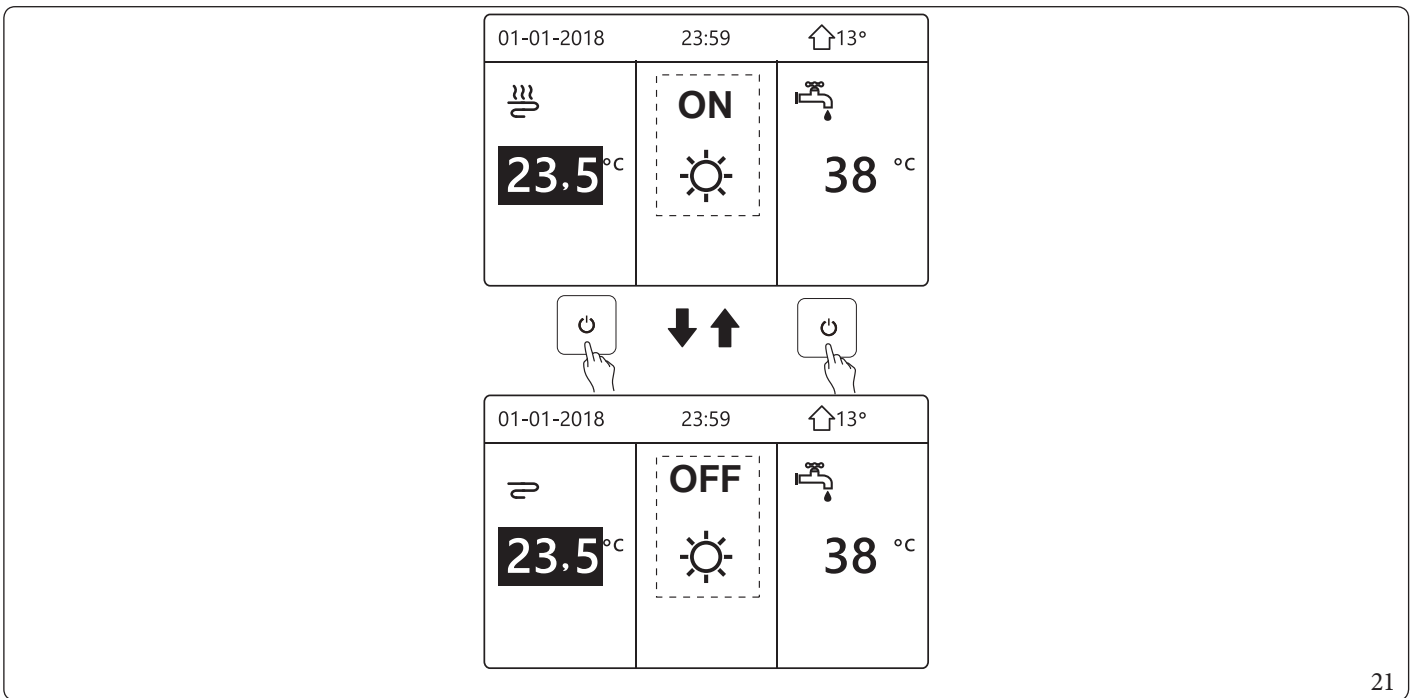

21



**Use the room thermostat to switch space heating or cooling on or off.**

- 1) The room thermostat is set at "ONE ZONE" or "DOUBLE ZONE" or "MODESET" (see "6. ROOM THERMOSTAT" in the Use and Installation Booklet). The unit for space heating or cooling is activated or deactivated from the room thermostat. If you press "⏪" on the control panel, the following page will appear:

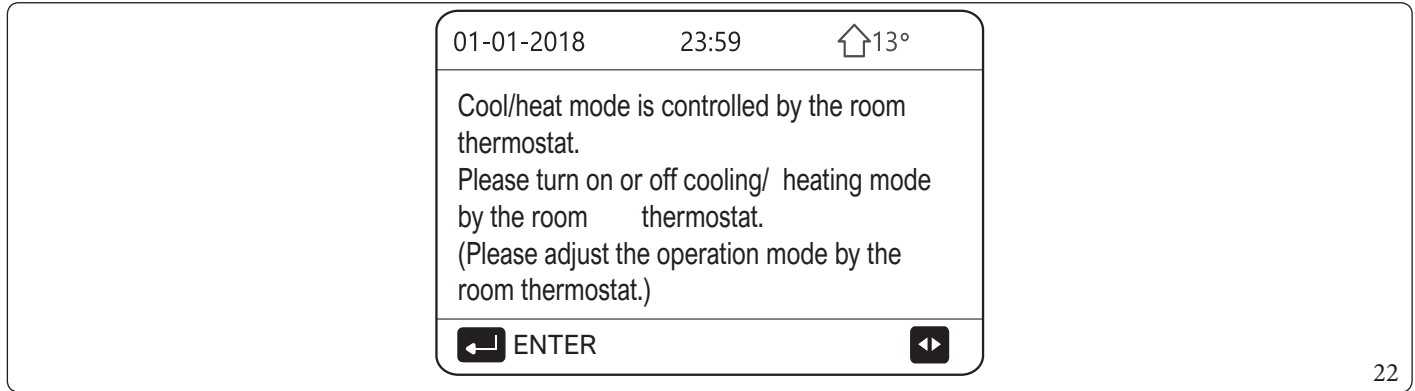

- 2) The room thermostat is set at "ONE ZONE" or "DOUBLE ZONE" (see "6. ROOM THERMOSTAT" in the Use and Installation Booklet). The room thermostat controls the ON/OFF operating mode of the unit, set on the control panel. The following pages show the control of the DOUBLE ZONE room thermostat.

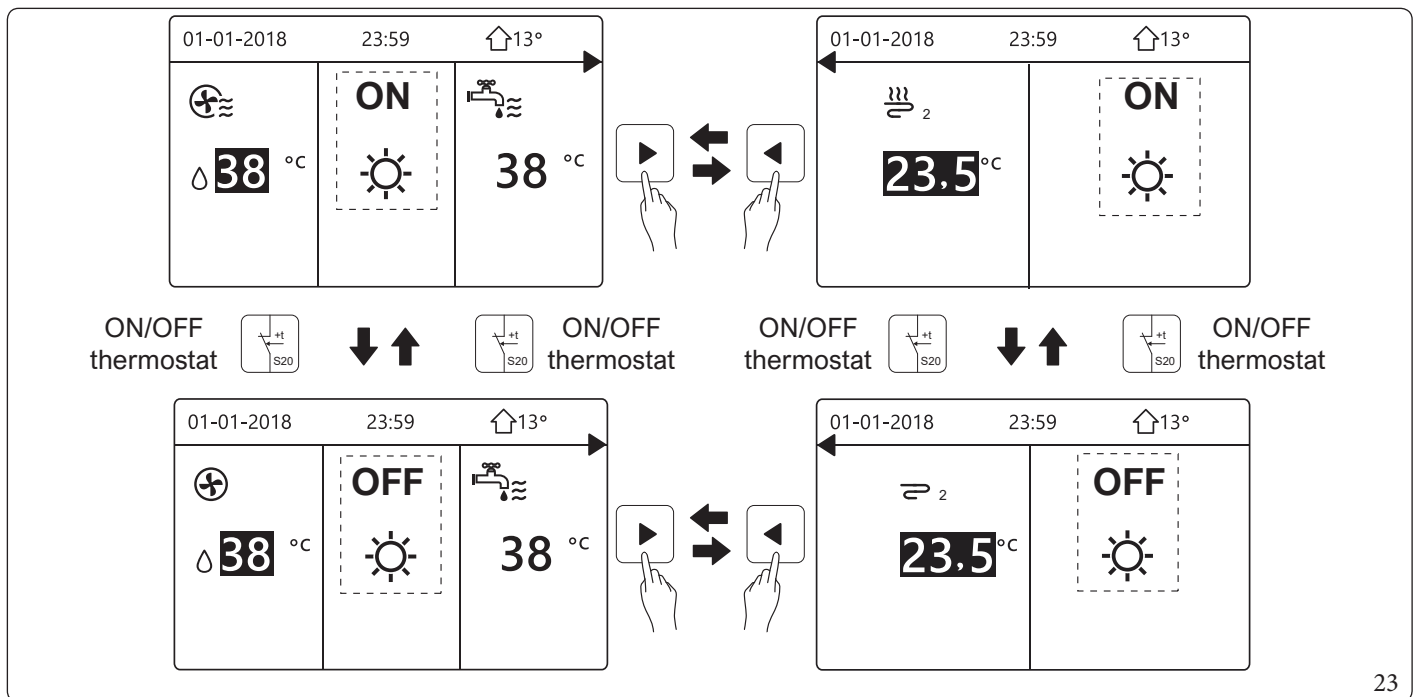

**Use the control panel to switch the "DHW" unit on or off. Press "⏪" and "⏩" on the home page, the black cursor will appear:**

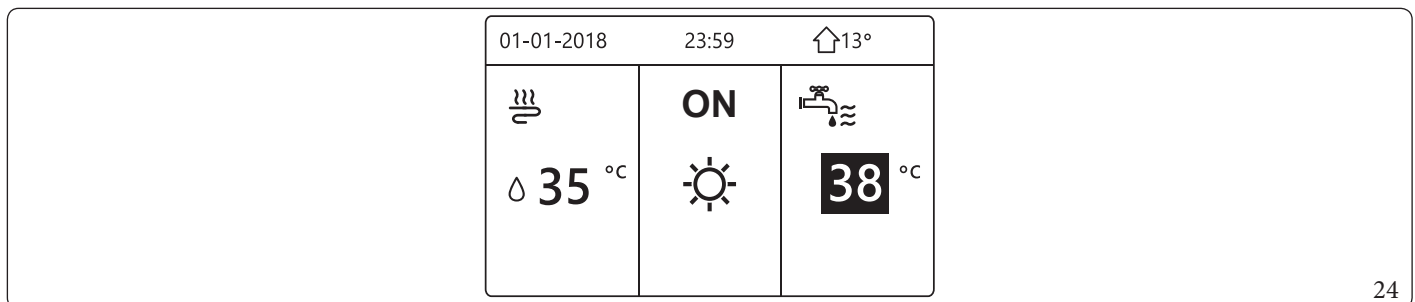

- 1) When the cursor is on the temperature of the "13.2 DHW MODE", press the "⏻" key to activate or deactivate it.
- If the space operation mode is activated (ON), the following pages appear:

The image shows two sequential screenshots of a control panel interface. At the top, a header bar displays the date '01-01-2018', the time '23:59', and a house icon with '13°'. Below this, the interface is divided into three columns. The left column contains a wavy line icon and a water drop icon with '35 °C'. The middle column displays 'ON' above a sun icon. The right column features a dashed box around a tap icon with a wavy line, and below it, the number '38 °C' is highlighted in a black box. Between the two screenshots, there are three icons: a hand pressing a power button, a downward arrow, an upward arrow, and another hand pressing a power button.

If the space operation mode is deactivated (OFF), the following pages appear:

The image shows two sequential screenshots of a control panel interface. At the top, a header bar displays the date '01-01-2018', the time '23:59', and a house icon with '13°'. Below this, the interface is divided into three columns. The left column contains a wavy line icon and a water drop icon with '35 °C'. The middle column displays 'ON' above a sun icon. The right column features a dashed box around a tap icon with a wavy line, and below it, the number '38 °C' is highlighted in a black box. Between the two screenshots, there are three icons: a hand pressing a power button, a downward arrow, an upward arrow, and another hand pressing a power button.



### 5.3 ADJUSTING THE TEMPERATURE.

Press “◀” and “▶” on the home page, the black cursor will appear:

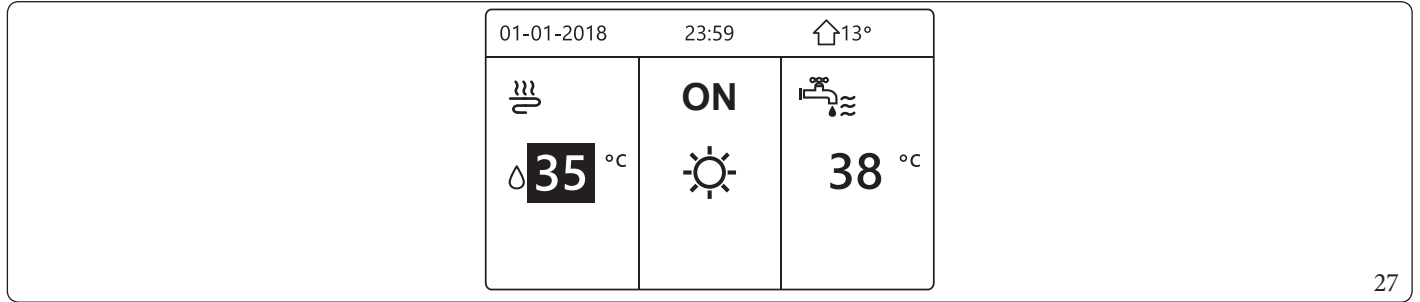

- If the cursor is on the temperature, use “◀” and “▶” to select (Fig. 28) and use “▼” and “▲” to adjust the temperature (Fig. 29).

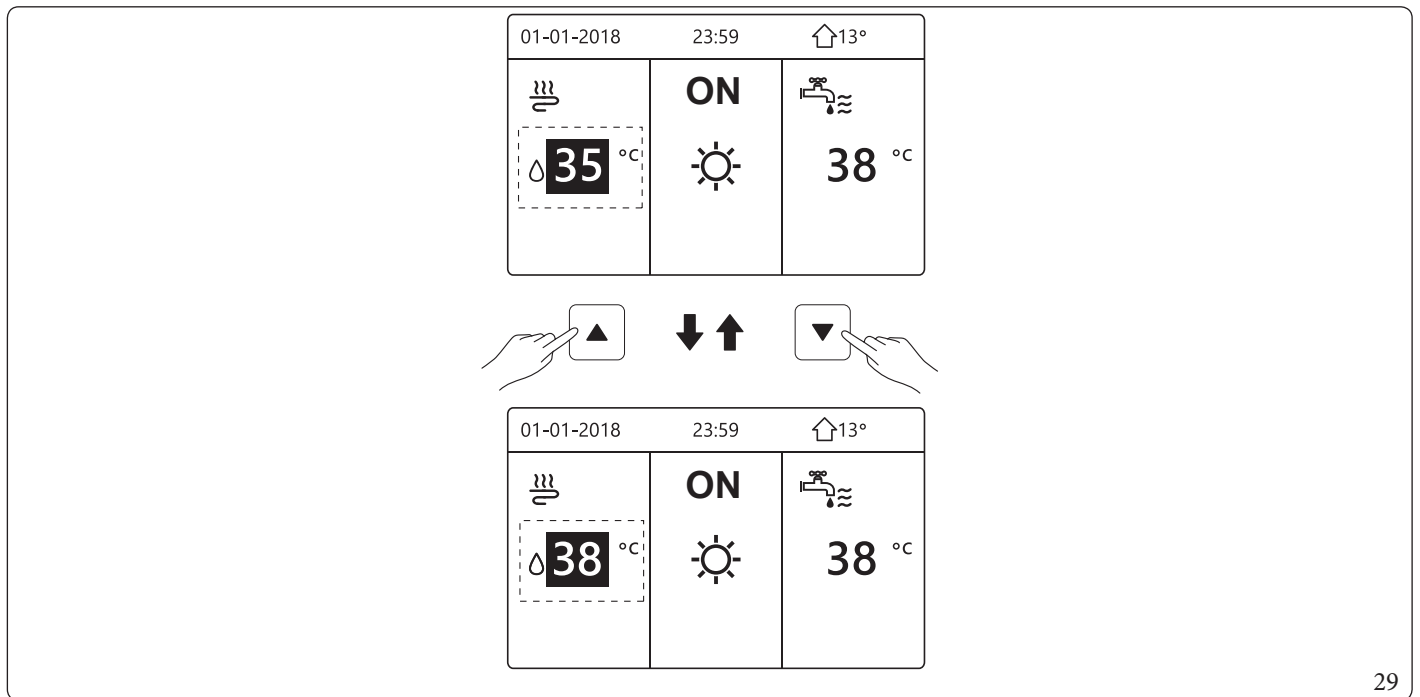
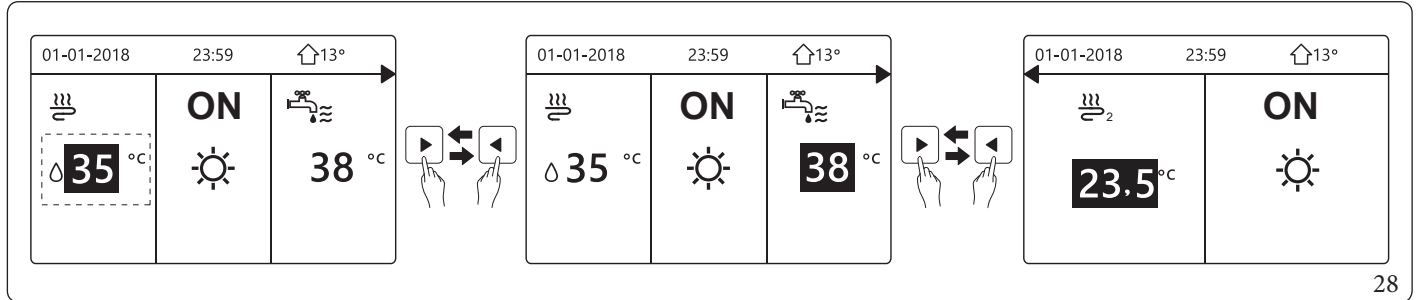

## 5.4 ADJUSTING SPACE OPERATION MODE.

- Adjusting space operation mode from control panel.

Go to "☰" > "OPERATE MODE". Press ←, the following page will appear:

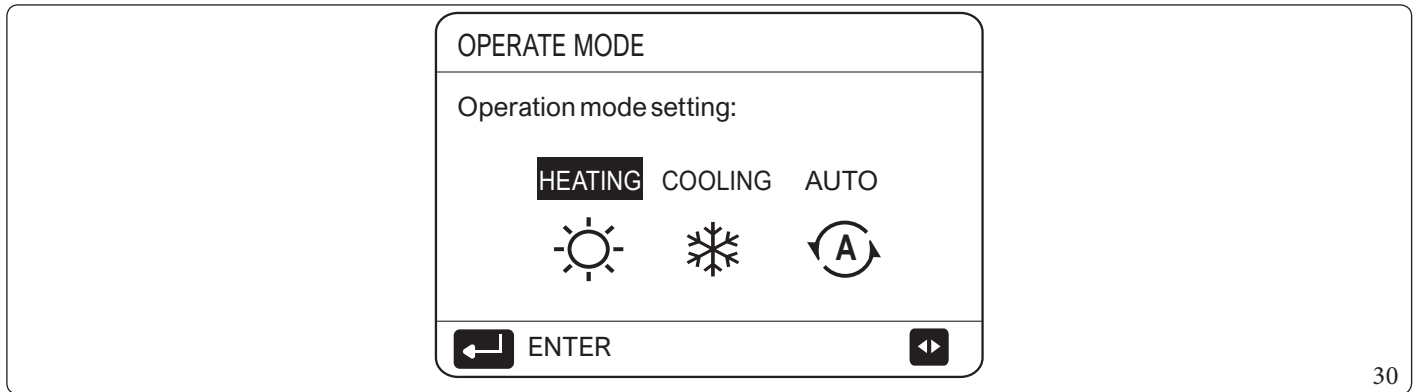

30

- You may select three modes, namely "HEATING", "COOLING" and "AUTO". Use "◀" and "▶" to scroll, press ← to select. If you do not press ← and you exit the page by pressing ↻, the mode will remain operational if the cursor was moved to the operation mode.

If only "HEATING" mode (COOLING) is available, the following page will appear:

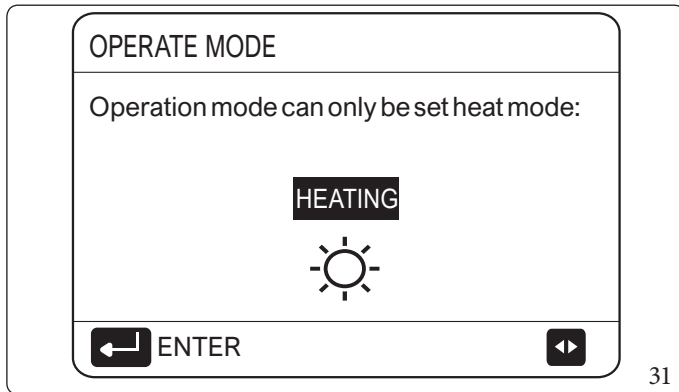

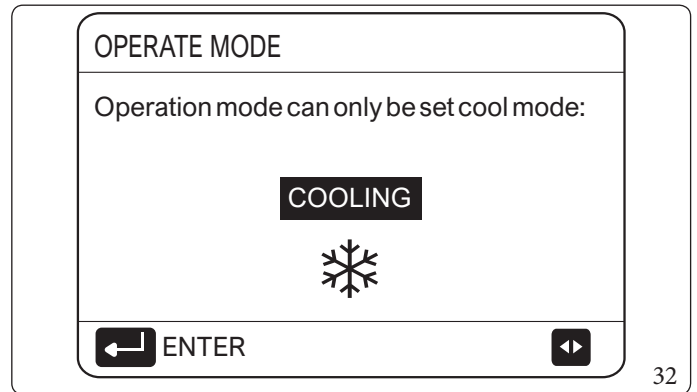

31





32

- The operation mode cannot be changed.



If you select...	Then the space operation mode is...
 HEATING	Always in Central heating
 COOLING	Always in Cooling
 AUTO	Setting automatically changed by the software based on the outdoor temperature (and depending on installer settings of the outdoor temperature), and taking monthly restrictions into account. Note: the automatic change is only possible under certain conditions. See "FOR SERVICEMAN" > "4. AUTO MODE SETTING" in the Use and Installation Booklet



- Adjust the operation mode from the room thermostat (see “6. ROOM THERMOSTAT” in the Use and Installation Booklet). Go to “” > “OPERATE MODE”. If you press any key for a selection or adjustment, the following page appears:

01-01-2018      23:59       13°

Cool/heat mode is controlled by the room thermostat.  
Please turn on or off cooling/ heating mode by the room thermostat.  
(Please adjust the operation mode by the room thermostat.)

 ENTER 



# 6 OPERATION.

## 6.1 OPERATION MODE.

See Paragraph 5.4 "Adjusting space operation mode".

## 6.2 PRESET TEMPERATURE.

"PRESET TEMPERATURE" has 3 elements:

- PRESET TEMP.:
- WEATHER TEMP.SET;
- ECOMODE.

### PRESET TEMP.:

The "PRESET TEMP." function allows you to set a different temperature at a different time when Heat or Cool mode is active.

- PRESET TEMP. =PRESET TEMPERATURE
- The "PRESET TEMPERATURE" function is deactivated under these conditions:
  - 1) the "AUTO" mode is on;
  - 2) "TIMER" or "WEEKLY SCHEDULE CHECK" are running.
- Go to "☐" > "PRESET TEMPERATURE" > "PRESET TEMP.". Press .
- The following page is displayed:

PRESET TEMPERATURE 1/2			
PRESET TEMP.		WEATHER TEMP.SET	ECO MODE
NO.		TIME	TEMP.
1	<input type="checkbox"/>	00:00	25°C
2	<input type="checkbox"/>	00:00	25°C
3	<input type="checkbox"/>	00:00	25°C

34

PRESET TEMPERATURE 2/2			
PRESET TEMP.		WEATHER TEMP.SET	ECO MODE
NO.		TIME	TEMP.
4	<input type="checkbox"/>	00:00	25°C
5	<input type="checkbox"/>	00:00	25°C
6	<input type="checkbox"/>	00:00	25°C

35

When the "DOUBLE ZONE" function is activated, "PRESET TEMP." is only active for zone 1.

Use , , , to scroll and use and to adjust the time and the temperature.

When the cursor is on "■", as in the following page;

Press and "■" becomes "☑". Timer 1 is selected. Press again and "☑" becomes "☐". Timer 1 is unselected.

PRESET TEMPERATURE 1/2			
PRESET TEMP.		WEATHER TEMP.SET	ECO MODE
NO.		TIME	TEMP.
1	■	00:00	25°C
2	<input type="checkbox"/>	00:00	25°C
3	<input type="checkbox"/>	00:00	25°C
☑ SELECT			

36

PRESET TEMPERATURE 1/2			
PRESET TEMP.		WEATHER TEMP.SET	ECO MODE
NO.		TIME	TEMP.
1	☑	08:00	35°C
2	☑	12:00	25°C
3	☑	15:00	35°C
☑ CANCEL			

37

Use , , , to scroll and use and to adjust the time and temperature. Six periods and six temperatures can be set.





For example: now it is 8:00 and the temperature is 30°C. We set "PRESET TEMP." as in the table below. The following page is displayed:

NO.	TIME	TEMPER.
1	8:00	35°C
2	12:00	25°C
3	15:00	35°C
4	18:00	25°C
5	20:00	35°C
6	23:00	25°C

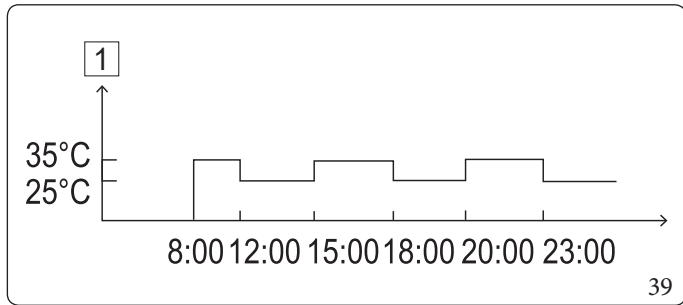

Key (Fig. 39):  
1 - Temperature

**i** When the space operation mode is changed, PRESET TEMP. automatically switches off. The "PRESET TEMP." function can be used in Heating or Cooling. However if the operation mode is changed, the "PRESET TEMP." function needs to be restored. The current preset temperature is not valid when the unit is OFF. When the unit is switched back on, it will run at the next preset temperature.

### WEATHER TEMP.SET

- WEATHER TEMP.SET = CLIMATE TEMPERATURE SETTING
- The "WEATHER TEMP.SET" function allows you to preset the desired water flow temperature based on the outdoor air temperature. When the weather heats up, heating is turned down. Therefore to save energy, the desired water flow temperature is reduced when the outdoor temperature increases and the "HEATING mode is active.

Goto "☐" > "PRESET TEMPERATURE" > "WEATHER TEMP.SET". Press .

The following page is displayed:





• "WEATHER TEMP.SET" has four types of curves:

- 1) the high temperature heating setting curve;
- 2) the low temperature heating setting curve;
- 3) the high temperature cooling setting curve;
- 4) the low temperature cooling setting curve.

Use only the high temperature heating setting curve if high temperature is set for central heating.

Use only the low temperature heating setting curve if low temperature is set for central heating.

Use only the high temperature cooling setting curve if high temperature is set for cooling.

Use only the low temperature cooling setting curve if low temperature is set for cooling.

- See "FOR SERVICEMAN" > "2.COOL MODE SETTING" and > "3. HEAT MODE SETTING" in the Use and Installation Booklet.
- It is not possible to adjust the desired temperature (T1S), when the temperature curve is set at "ON".

- To use the "HEATING" mode in zone 1, select "ZONE1 H-MODE HIGH TEMP.". To use the "COOLING" mode in zone 1, select "ZONE1 C-MODE HIGH TEMP.". Selecting "ON" displays the following page:

41

Use "◀" and "▶" to scroll. Press "↵" to select.

PRESET TEMP.	WEATHER TEMP.SET	ECO MODE
ZONE1 C-MODE LOW TEMP.		ON
ZONE1 H-MODE LOW TEMP.		OFF
ZONE2 C-MODE LOW TEMP.		OFF
ZONE2 H-MODE LOW TEMP.		OFF

42

- If the "WEATHER TEMP.SET" function is on, the desired temperature cannot be adjusted on the control panel. If "▼" and "▲" are pressed to adjust the temperature on the home page. The following page is displayed:

43



- Move to "NON", press to go back to the home page. Move to "YES", press to reset "WEATHER TEMP.SET".

PRESET TEMPERATURE		
PRESET TEMP.	WEATHER TEMP.SET	ECO MODE
ZONE1 C-MODE LOW TEMP.		OFF
ZONE1 H-MODE LOW TEMP.		OFF
ZONE2 C-MODE LOW TEMP.		OFF
ZONE2 H-MODE LOW TEMP.		OFF
ON/OFF		

44

### ECO MODE.

Eco Mode allows you to save energy. Go to > "PRESET TEMPERATURE" > "ECO MODE". Press . The following page is displayed:

PRESET TEMPERATURE		
PRESET TEMP.	WEATHER TEMP.SET	ECO MODE
CURRENT STATE		OFF
ECOTIMER		OFF
START		08:00
END		19:00
ON/OFF		

45

Press . The following page is displayed:

ECO MODE SET									
ECO MODE SET TYPE									
1	2	3	4	5	6	7	8	9	
			ENTER						

46



Use “◀” and “▶” to scroll. Press “↵” to select. The following page is displayed:

PRESET TEMPERATURE		
PRESET TEMP.	WEATHER TEMP.SET	ECO MODE
CURRENT STATE		ON
ECOTIMER		OFF
START		08:00
END		19:00
ON/OFF		

47

Use “⏻” to activate/deactivate; use “▼” and “▲” to scroll.

PRESET TEMPERATURE		
PRESET TEMP.	WEATHER TEMP.SET	ECO MODE
CURRENT STATE		OFF
ECOTIMER		OFF
START		08:00
END		19:00
ADJUST		

48

When the cursor is on “START” or “END”, you can use “◀”, “▶”, “▼”, “▲” to scroll and “▼” and “▲” to adjust the time.



- "ECO MODE SET" has two types of curves:
  - 1) the high temperature heating setting curve;
  - 2) the low temperature heating setting curve;

There is only the high temperature heating setting curve if high temperature is set for central heating.

There is only the low temperature heating setting curve if low temperature is set for central heating.

- See “FOR SERVICEMAN” > “MODE SET HEATING” in the Use and Installation Booklet.
- It is not possible to adjust the desired temperature (T1S), when the "ECO MODE" is activated (ON).
- You may select the low or high temperature setting for heating: see “Table 1-2”.
- If "ECO MODE" is activated (ON) and "ECO TIMER" is deactivated (OFF), the unit will always run in "ECO" mode.
- If "ECO MODE" is activated (ON) and "ECO TIMER" is activated (ON), the unit will work in "ECO" mode based on the start and end time.



### 6.3 DOMESTIC HOT WATER (DHW).

"DHW" mode normally includes the following items:

- DISINFECT;
- FAST DHW;
- TANK HEATER;
- DHW PUMP.

#### DISINFECT.

The "DISINFECT" function allows you to eliminate legionella bacteria. The storage tank temperature mandatorily reaches 65-70°C in the disinfect function.

The disinfect temperature is set in "13.2 DHW MODE". See "FOR SERVICEMAN" > "1. DHW MODE SETTING" > "1.2 DISINFECT" in the Use and Installation Booklet.





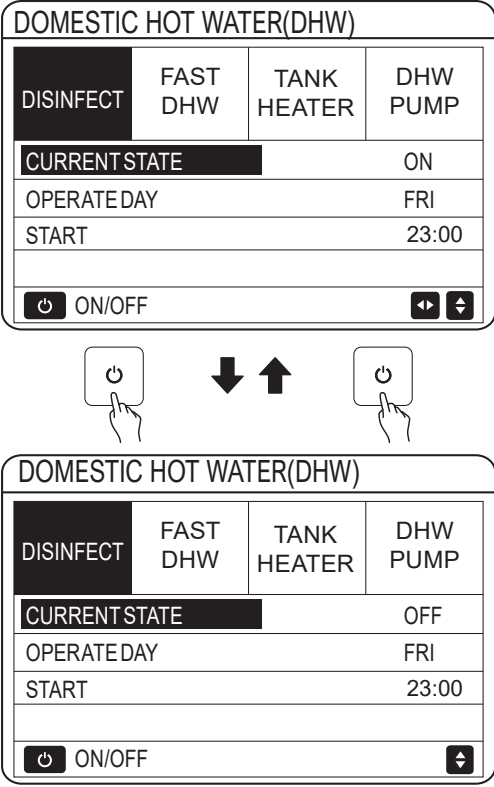

Goto  > "DOMESTIC HOT WATER(DHW)" > "DISINFECT". Press .

The following page is displayed:



The diagram illustrates the process of toggling the DHW Disinfect function. It shows two screenshots of the 'DOMESTIC HOT WATER(DHW)' menu. The first screenshot shows the 'DISINFECT' option selected, with 'CURRENT STATE' set to 'ON' and 'ON/OFF' set to 'ON/OFF'. The second screenshot shows the 'DISINFECT' option selected, with 'CURRENT STATE' set to 'OFF' and 'ON/OFF' set to 'ON/OFF'. Arrows and hand icons indicate the sequence of button presses: pressing the power button to toggle the state, and using the up/down arrows to navigate between options.

49

Use ", ", ", "" to scroll and use "" and "" to adjust the parameters when setting "OPERATEDAY" and "START". If "OPERATEDAY" is set at "FRI" and "START" is set at 23:00, the disinfect function will activate on Friday at 23:00.

If the disinfect function is active, the following page appears:

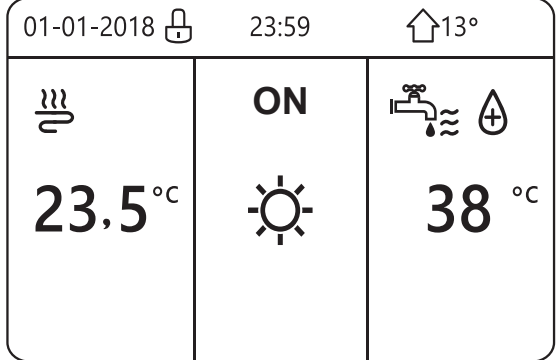

The screenshot shows the DHW Disinfect active screen. At the top, it displays the date '01-01-2018', the time '23:59', and the room temperature '13°C'. The main display is divided into three sections: a water temperature of 23.5°C, the status 'ON' with a sun icon, and a tank temperature of 38°C with a water tap icon.

50



**FAST DHW.**

The "FAST DHW" function forces the system to activate "13.2 DHW MODE".

The heat pump and storage tank heater activate together for "13.2 DHW MODE" and the desired DHW temperature switches to 60°C.

Go to "☰" > "DOMESTIC HOT WATER(DHW)" > "FAST DHW". Press ← ↵.

The diagram illustrates the navigation and state change for the "DOMESTIC HOT WATER(DHW)" function. It shows two states of the menu:

- Top State (ON):** The "FAST DHW" option is highlighted in black. The "CURRENT STATE" is "ON". A power button icon is shown at the bottom left of the menu.
- Navigation:** Between the two menu states are three icons: a power button icon with a hand pointing to it, a downward arrow, an upward arrow, and another power button icon with a hand pointing to it.
- Bottom State (OFF):** The "FAST DHW" option is highlighted in black. The "CURRENT STATE" is "OFF". A power button icon is shown at the bottom left of the menu.

Use the  key to select activated (ON) or deactivated (OFF).

-  If "CURRENT STATE" is deactivated (OFF), the "FAST DHW" function is not valid, while if it is activated (ON), the "FAST DHW" function is active.
- The "FAST DHW" activates once.

## TANK HEATER

The "TANK HEATER" function forces water heating in the storage tank. In the same situation, cooling or heating is required and the heat pump system is operating for cooling or heating. However there is a domestic hot water demand as well.

Furthermore, if the heat pump system is not sufficient, the "TANK HEATER" can also be used to heat water in the storage tank.

Go to > "DOMESTIC HOT WATER(DHW)" > "TANK HEATER". Press .

DOMESTIC HOT WATER(DHW)			
DISIN- FECT	FAST DHW	TANK HEATER	DHW PUMP
CURRENT STATE			ON
ON/OFF			

DOMESTIC HOT WATER(DHW)			
DISIN- FECT	FAST DHW	TANK HEATER	DHW PUMP
CURRENT STATE			OFF
ON/OFF			

52

Use to select activated (ON) or deactivated (OFF). Use to exit.

If "TANK HEATER" is active, the following page will appear:

01-01-2018		23:59	13°
  <b>35</b> °C	<b>ON</b>  	  <b>38</b> °C  	

53



If "CURRENT STATE" is deactivated (OFF), "TANK HEATER" cannot be activated. If the storage tank sensor (T5) is faulty, the storage tank heater cannot work.



**DHW PUMP.**

The "DHW PUMP" function allows to maintain the temperature inside the storage tank uniform, by activating a DHW recirculation pump.

Go to "☐" > "DOMESTIC HOT WATER(DHW)" > "DHW PUMP". Press "←".

The following page is displayed:

DOMESTIC HOT WATER(DHW) 1/2

DISINFECT	FAST DHW	TANK HEATER	DHW PUMP
NO.	START	NO.	START
T1 <input type="checkbox"/>	00:00	T4 <input type="checkbox"/>	00:00
T2 <input type="checkbox"/>	00:00	T5 <input type="checkbox"/>	00:00
T3 <input type="checkbox"/>	00:00	T6 <input type="checkbox"/>	00:00

⬇ ⬅

DOMESTIC HOT WATER(DHW) 2/2

DISINFECT	FAST DHW	TANK HEATER	DHW PUMP
NO.	START	NO.	START
T7 <input type="checkbox"/>	00:00	T10 <input type="checkbox"/>	00:00
T8 <input type="checkbox"/>	00:00	T11 <input type="checkbox"/>	00:00
T9 <input type="checkbox"/>	00:00	T12 <input type="checkbox"/>	00:00

⬇ ⬅

Move to "■", press "←" to select or unselect (☑ the timer is selected; ☐ the timer is not selected).

DOMESTIC HOT WATER(DHW) 1/2

DISINFECT	FAST DHW	TANK HEATER	DHW PUMP
NO.	START	NO.	START
T1 <input checked="" type="checkbox"/>	00:00	T4 <input type="checkbox"/>	00:00
T2 <input type="checkbox"/>	00:00	T5 <input type="checkbox"/>	00:00
T3 <input type="checkbox"/>	00:00	T6 <input type="checkbox"/>	00:00

⬇ ⬅

Use "◀", "▶", "▼", "▲" to scroll and use "▼" and "▲" to adjust the parameters.

For example: the parameter relative to "DHW PUMP" was set (see "FOR SERVICEMAN" > "1. DHW MODE SETTING" in the Use and Installation Booklet). "PUMP\_DRUNNINGTIME" is 30 minutes.

NO.	START
1	6:00
2	7:00
3	8:00
4	9:00

The PUMP is switched on as shown below:

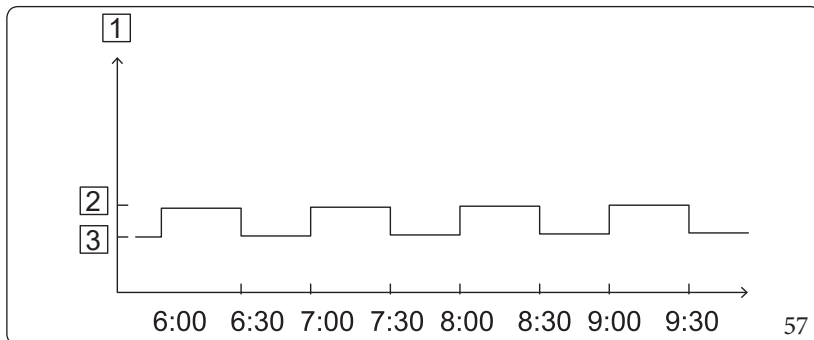

- Key (Fig. 57):
- 1 - Pump
  - 2 - ON
  - 3 - OFF







## 6.4 PROGRAMMING.

The "SCHEDULE" menu contains the following items:



- TIMER;
- WEEKLY SCHEDULE;
- SCHEDULE CHECK;
- CANCEL TIMER.

### TIMER.

If the weekly schedule is on and the timer is off, the most recent setting applies. If the "TIMER" is on,  is displayed on the home page.

SCHEDULE					1/2
TIMER	WEEKLY SCHEDULE	SCHED-ULE CHECK	CANCEL TIMER		
NO.	START	END	MODE	TEMP.	
1 <input type="checkbox"/>	00:00	00:00	HEATING	0°C	
2 <input type="checkbox"/>	00:00	00:00	HEATING	0°C	
3 <input type="checkbox"/>	00:00	00:00	HEATING	0°C	
 					

58

SCHEDULE					2/2
TIMER	WEEKLY SCHEDULE	SCHED-ULE CHECK	CANCEL TIMER		
NO.	START	END	MODE	TEMP.	
4 <input type="checkbox"/>	00:00	00:00	HEATING	0°C	
5 <input type="checkbox"/>	00:00	00:00	HEATING	0°C	
6 <input type="checkbox"/>	00:00	00:00	HEATING	0°C	
 					

59

Use ", ", ", "" to scroll and use "" and "" to adjust the time, the mode and the temperature.

Move to "", press  to select or unselect ( the timer is selected;  the "TIMER" is not selected). Six timers can be set.

To cancel the "TIMER", move the cursor to "", and press . The icon  becomes  and the "TIMER" is not active.

If you set the start time later than the end time (or the temperature out of range of the mode), the following page appears:

SCHEDULE			
TIMER	WEEKLY SCHEDULE	SCHED-ULE CHECK	CANCEL TIMER
Timer is useless.  Please check the timer setting.			
 ENTER			

60

- Example:

Six timers are set as follows:

NO.	START	END	MODE	TEMP.
T1	1:00	3:00	DHW	50°C
T2	7:00	9:00	HEATING	28°C
T3	11:30	13:00	COOLING	20°C
T4	14:00	16:00	HEATING	28°C
T5	15:00	19:00	COOLING	20°C
T6	18:00	23:30	DHW	50°C



The PUMP is switched on as shown below:

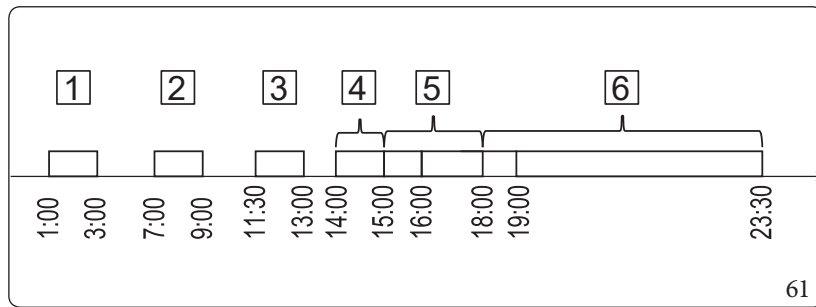

Key (Fig. 61):

- 1 - DHW
- 2 - HEATING
- 3 - COOLING
- 4 - HEATING
- 5 - COOLING
- 6 - DHW

The control panel switches on at the following times:

TIME	Operation of the control panel
1:00	The "13.2 DHW MODE" is activated (ON)
3:00	"13.2 DHW MODE" is deactivated (OFF)
7:00	The "HEAT MODE" is activated (ON)
9:00	"HEAT MODE" is deactivated (OFF)
11:30	The "COOL MODE" is activated (ON)
13:00	"COOL MODE" is deactivated (OFF)
14:00	The "HEAT MODE" is activated (ON)
15:00	"COOL MODE" is activated (ON) and "HEAT MODE" is deactivated (OFF)
18:00	"13.2 DHW MODE" is activated (ON) and "COOL MODE" is deactivated (OFF)
23:30	"13.2 DHW MODE" is deactivated (OFF)



The timer is not valid if the start and end time are the same.

## Weekly schedule.

If the timer is on and the weekly schedule is off, the most recent setting applies.

If the "WEEKLY SCHEDULE" function is on, "7" appears on the home page

Go to "☐" > "SCHEDULE" > "WEEKLY SCHEDULE". Press "↵".

The following page is displayed:

SCHEDULE						
TIMER	WEEKLY SCHEDULE	SCHEDULE CHECK	CANCEL TIMER			
MON	Mar	WED	THU	FRI	SAT	SUN
■	☐	☐	☐	☐	☐	☐
ENTER			CANCEL			
← FRI SELECT			↕ ↔			

62

First select the days of the week you wish to schedule.

Use "◀" and "▶" to scroll, press "↵" to select or unselect the day.

"MON" indicates that the day is selected, "MON" means that that day is selected.

 At least two days must be set when activating the "WEEKLY SCHEDULE" function.

SCHEDULE						
TIMER	WEEKLY SCHEDULE	SCHEDULE CHECK	CANCEL TIMER			
MON	Mar	WED	THU	FRI	SAT	SUN
☐	☐	☐	☐	■	☐	☐
ENTER			CANCEL			
← FRI SELECT			↕ ↔			

63

Use "◀" and "▶" to scroll, press "↵" to SET and press "ENTER". Monday to Friday are selected and they have the same schedule.

The following pages are displayed:

SCHEDULE					1/2
TIMER	WEEKLY SCHEDULE	SCHEDULE CHECK	CANCEL TIMER		
NO.	START	END	MODE	TEMP.	
1	☐	00:00	00:00	HEATING	0°C
2	☐	00:00	00:00	HEATING	0°C
3	☐	00:00	00:00	HEATING	0°C
					↕ ↔

64

SCHEDULE					2/2
TIMER	WEEKLY SCHEDULE	SCHEDULE CHECK	CANCEL TIMER		
NO.	START	END	MODE	TEMP.	
4	☐	00:00	00:00	HEATING	0°C
5	☐	00:00	00:00	HEATING	0°C
6	☐	00:00	00:00	HEATING	0°C
					↕ ↔

65

Use "◀", "▶", "▼", "▲" to scroll and adjust the time, the mode and the temperature.

Several timer settings can be made, including start and end time, mode and temperature. "HEAT MODE", "COOL MODE" and "13.2 DHW MODE" are included.

The setting method refers to the timer setting. The end time must be later than the start time. Otherwise the Timer useless indication will appear, namely that it cannot be activated.



### Schedule check.

The "SCHEDULE CHECK" function can only check the weekly schedule.

Go to > "SCHEDULE" > "SCHEDULE CHECK". Press . The following page is displayed:

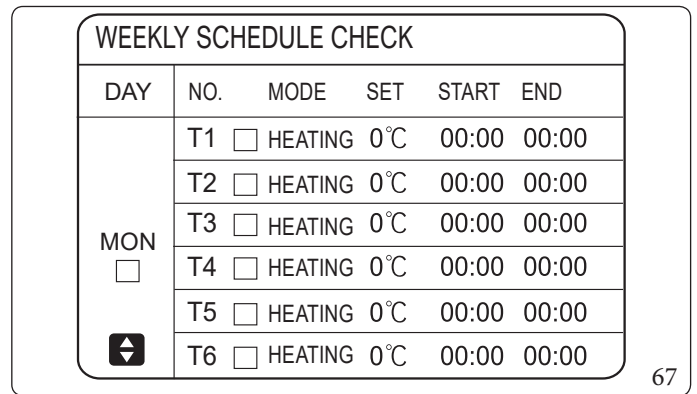
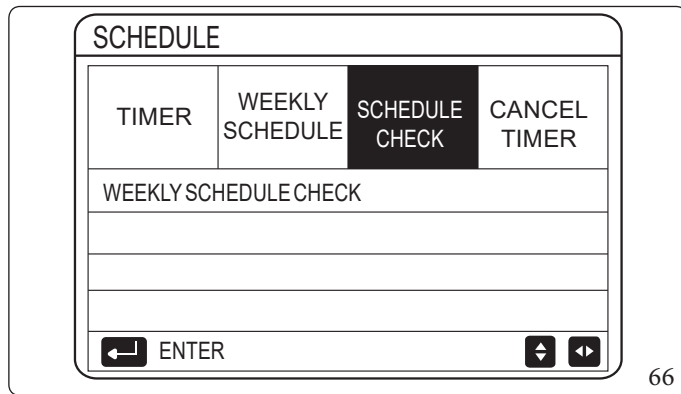

Press and , the Monday to Sunday timer is displayed.

### CANCEL TIMER.

Go to > "SCHEDULE" > "CANCEL TIMER". Press .

The following page is displayed:

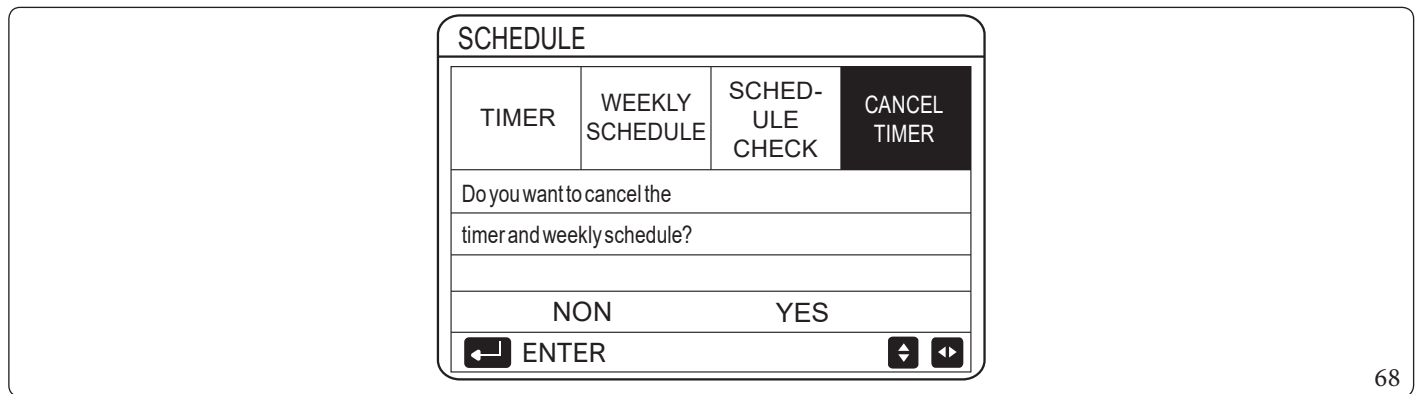

Use , , , to move to "YES", press to cancel the timer.

To exit "CANCEL TIMER", press .

If the "TIMER" or "WEEKLY SCHEDULE" functions are on, the timer icon or the weekly schedule icon appear on the home page.

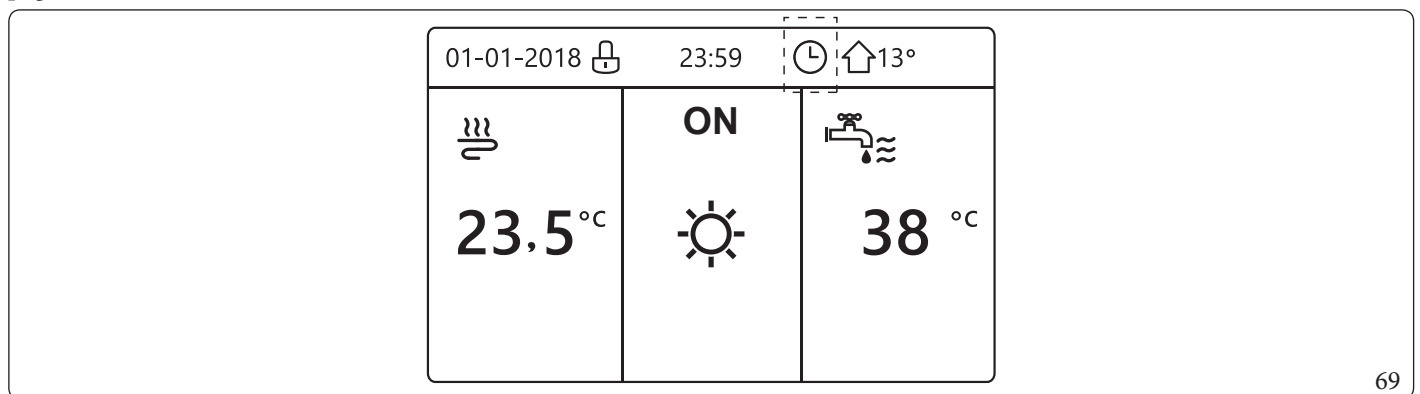

If the "TIMER" or "WEEKLY SCHEDULE" is cancelled, the icon "☺" or "7" disappears from the home page.

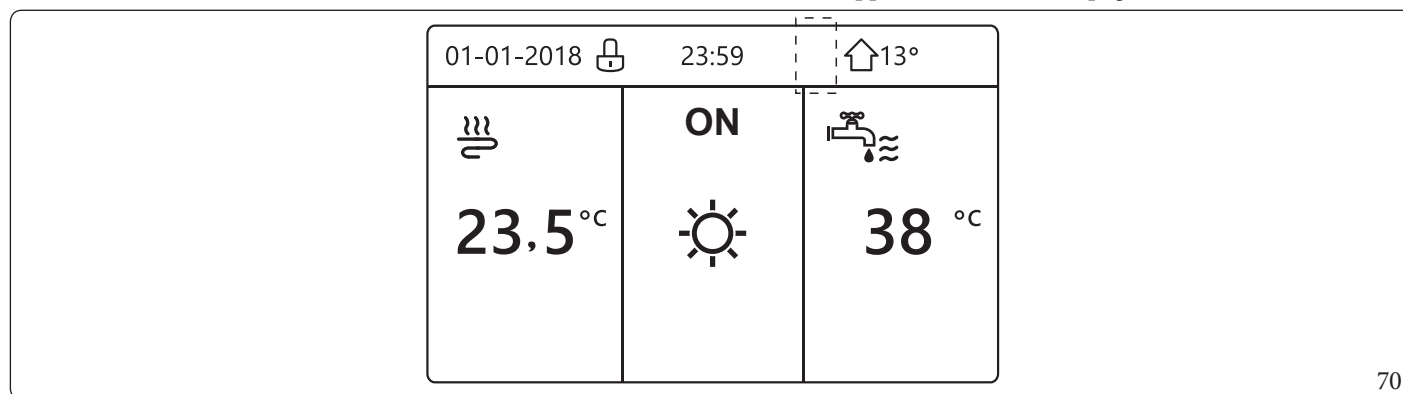

**i** "TIMER"/"WEEKLY SCHEDULE" must be restored if switching from setting "5.1 WATER FLOW TEMP." to "5.2 ROOM TEMP." or from setting "5.2 ROOM TEMP." to "5.1 WATERFLOW TEMP."  
"TIMER" or "WEEKLY SCHEDULE" are not valid if "6. ROOM THERMOSTAT" is active.

- i**
- "ECO" has the highest priority. "TIMER" or "WEEKLY SCHEDULE" have the intermediate priority and "PRESET TEMP." or "WEATHER TEMP.SET" have the lowest priority.
  - "PRESET TEMP." or "WEATHER TEMP.SET" are no longer valid when "ECO" is on. You must reset "PRESET TEMP." or "WEATHER TEMP.SET" when "ECO" is deactivated.
  - "TIMER" or "WEEKLY SCHEDULE" are not valid when "ECO" is activated. "TIMER" or "WEEKLY SCHEDULE" are activated when "ECO" is not running.
  - "TIMER" or "WEEKLY SCHEDULE" have the same priority. The function with the most recent setting is applied. "PRESET TEMP." is no longer valid when "TIMER" or "WEEKLY SCHEDULE" are activated. "TIMER" or "WEEKLY SCHEDULE" have no effect on "WEATHER TEMP.SET".
  - "PRESET TEMP." and "WEATHER TEMP.SET" have the same priority. The function with the most recent setting is applied.

**i** All the items ("PRESET TEMP.", "ECO", "DISINFECT", "DHW PUMP", "TIMER", "WEEKLY SCHEDULE", "SILENT MODE", "HOLIDAY HOME") can be programmed by setting the relative function on "ON/OFF" from the starting time to the end time.



## 6.5 OPTIONS.

The "OPTIONS" menu contains the following items:

- SILENTMODE;
- HOLIDAY AWAY;
- HOLIDAY HOME;
- BACKUP HEATER.

### SILENT MODE

"SILENT MODE" allows you reduce the noise level of the unit. However this also reduces the heating/cooling capacity of the system. Silent mode has two levels.

Level 2 is quieter than level 1 and also has a lower heating or cooling capacity.

There are two ways to use the Silent mode:

1. Silent mode the whole time;
  2. Silent mode based on timer.
- Go to the home page to check whether Silent mode is on. If silent mode is activated, "☾" will be enabled on the home page.
  - Go to "☐" > "OPTIONS" > "SILENT MODE". Press "←" . The following page is displayed:

OPTIONS		1/2	
SILENT MODE	HOLIDAY AWAY	HOLIDAY HOME	BACKUP HEATER
CURRENT STATE			OFF
SILENT LEVEL			LEVEL 1
TIMER1 START			12:00
TIMER1 END			15:00
← ON/OFF		↕	

71

Use "⏻" to select activated (ON) or deactivated (OFF).

Description: if "CURRENT STATE" is set at "OFF", "SILENT MODE" is not valid.

Selecting "SILENT LEVEL" and pressing "←" or "▶" displays the following page:

*LEVEL 1*

OPTIONS			
SILENT MODE	HOLIDAY AWAY	HOLIDAY HOME	BACKUP HEATER
CURRENT STATE			ON
SILENT LEVEL			LEVEL 1
TIMER1 START			12:00
TIMER1 END			15:00
↕ ADJUST		↕	

72

*LEVEL 2*

OPTIONS			
SILENT MODE	HOLIDAY AWAY	HOLIDAY HOME	BACKUP HEATER
CURRENT STATE			ON
SILENT LEVEL			LEVEL 2
TIMER1 START			12:00
TIMER1 END			15:00
		↕ ↕	

73

You can use "▲" and "▼" to select level 1 or level 2. Press "←" .



If the silent "TIMER" is selected, press "↵" to enter. The following page is displayed:

SILENT MODE	HOLIDAY AWAY	HOLIDAY HOME	BACKUP HEATER
TIMER1			OFF
TIMER2 START			22:00
TIMER2 END			07:00
TIMER2			OFF
			⏪ ⏩

2/2

74

It is possible to set two timers. Move to "■", press "↵" to select or unselect.

If both timers are unselected, the Silent mode will remain active. Otherwise operation will be time-controlled.

### HOLIDAY AWAY.

- If the "HOLIDAY AWAY" mode is on,  is displayed on the home page.

The "HOLIDAY AWAY" function prevents the system from freezing during winter when away on vacation and reactivates the unit before the end of holidays.

Go to "☐" > "OPTIONS" > "HOLIDAY AWAY". Press "↵". The following page is displayed:

SILENT MODE	HOLIDAY AWAY	HOLIDAY HOME	BACKUP HEATER
CURRENT STATE			OFF
13.2 DHW MODE			ON
DISINFECT			ON
HEAT MODE			ON
⏪ ON/OFF			⏩

1/2

75

SILENT MODE	HOLIDAY AWAY	HOLIDAY HOME	BACKUP HEATER
FROM		00-00-2000	
UNTIL		00-00-2000	
			⏪

2/2

76

For example: you leave during winter. Today is 31/12/2018 and holidays start in two days (02/01/2019).

- Let's suppose that you are in this situation: in 2 days you will leave for 2 weeks during winter.
- You want to save energy but without the system freezing.

You can perform the following operations:

1. Configure the holiday away settings below.
2. Activate Holiday mode.

Go to "☐" > "OPTIONS" > "HOLIDAY AWAY". Press "↵".

Use  to select activated (ON) or deactivated (OFF) and use "◀", "▶", "▼", "▲" to scroll and adjust.

Setting	Value
HOLIDAY AWAY	ON
FROM	2 January 2018
UNTIL	16 January 2018
OPERATE MODE	HEATING
DISINFECT	ON





- If "13.2 DHW MODE" is on in "HOLIDAY AWAY" mode, the disinfection set by the user is not valid.
- If "HOLIDAY AWAY" mode is activated, the timer and weekly programming are not valid.
- If "CURRENT STATE" is deactivated (OFF), "HOLIDAY AWAY" is deactivated (OFF).
- If "CURRENT STATE" is activated (ON), "HOLIDAY AWAY" is activated (ON).
- The unit is disinfected at 23:00 on the last day, if the disinfect function is activated.
- When "HOLIDAY AWAY" mode is active, the previously set climatic curves are not valid and will automatically take effect at the end of the period set for "HOLIDAY AWAY".
- The preset temperature is not valid when "HOLIDAY AWAY" mode is on, but the preset value still appears on the home page.

## HOLIDAY HOME.

The "HOLIDAY HOME" function allows you to make changes to the normal schedule without needing to adjust them when spending holidays at home.



- During holidays, you may use Holiday mode to make changes to the normal schedules without needing to adjust them.

Period	Schedule
Before and after holidays	Normal schedules are activated
During holidays	The configured holiday settings are activated

If "HOLIDAY HOME" mode is activated,  will appear on the home page.

Go to  > "OPTIONS" > "HOLIDAY HOME". Press . The following page is displayed:

**OPTIONS**

SILENT MODE	HOLIDAY AWAY	HOLIDAY HOME	BACKUP HEATER
<b>CURRENT STATE</b>			OFF
FROM			00-00-2000
UNTIL			00-00-2000
TIMER			ENTER
 ON/OFF			

77

Use  to select activated (ON) or deactivated (OFF) and use , , ,  to scroll and adjust.

If "CURRENT STATE" is deactivated (OFF), "HOLIDAY HOME" is deactivated (OFF).

If "CURRENT STATE" is activated (ON), "HOLIDAY HOME" is activated (ON).

Use  and  to set the date.

- The normal schedule is activated before and after holidays.



If you change the operation mode of the unit, you must exit "HOLIDAY AWAY" or "HOLIDAY HOME".





## BACKUP HEATER

The "BACKUP HEATER" forces activation of the backup heater. Go to  > "OPTIONS" > "BACKUP HEATER".

Press .

- If the system backup heater (IBH) is not set as valid by the DIP switch on the main board of the hydronic module, the following page appears:

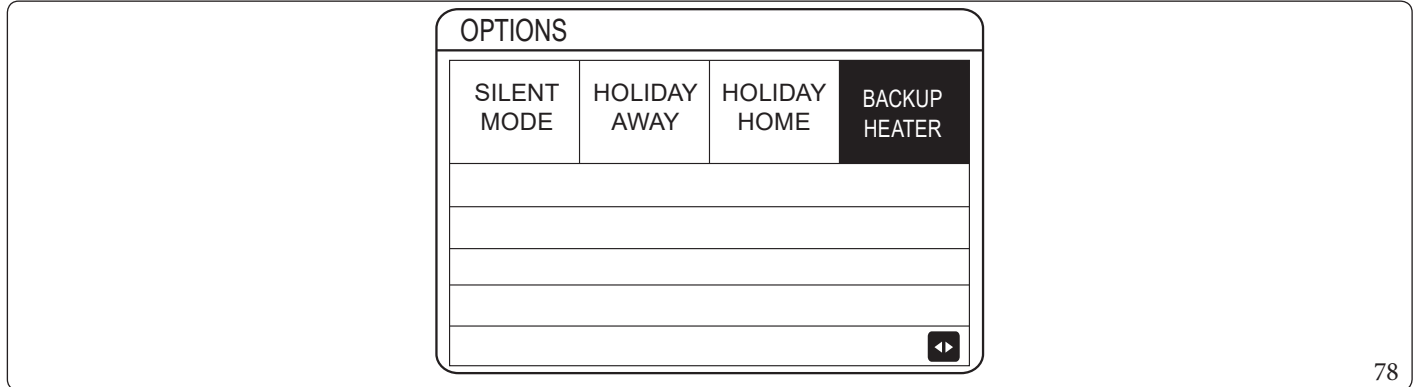

- If the system backup heater (IBH) is set as valid by the DIP switch on the main board of the hydraulic module, the following page appears:

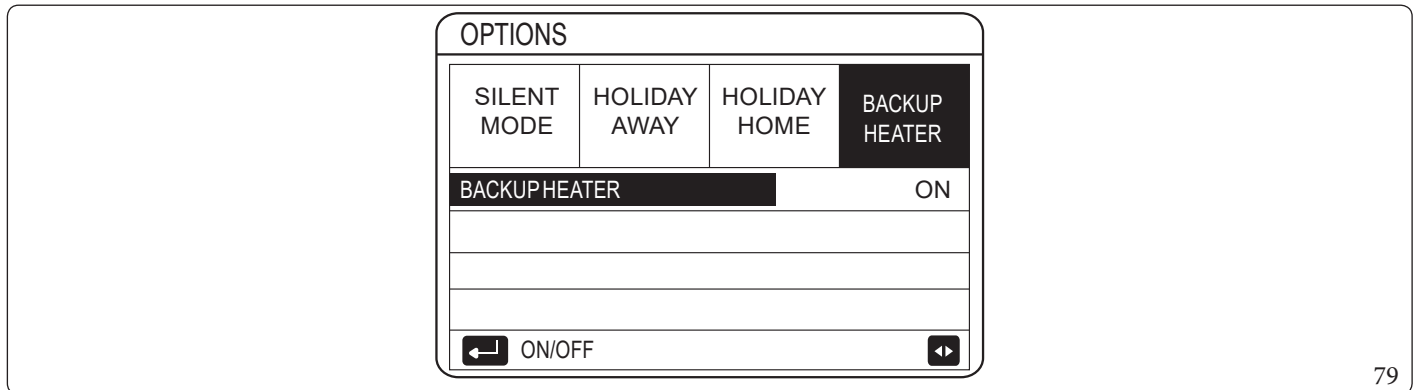

Use the  to select deactivated (OFF) or activated (ON).



- If automatic operation mode is set on the space heating or cooling side, the "BACKUP HEATER" function cannot be selected.
- The "BACKUP HEATER" function is not valid when only "HEAT MODE" is activated.



## 6.6 CHILD LOCK.

The "CHILD LOCK" function allows you to prevent children from improperly using the unit. Mode settings and temperature adjustments can be locked or unlocked by means of the "CHILD LOCK" function. Go to  > "CHILD LOCK". The following page is displayed:

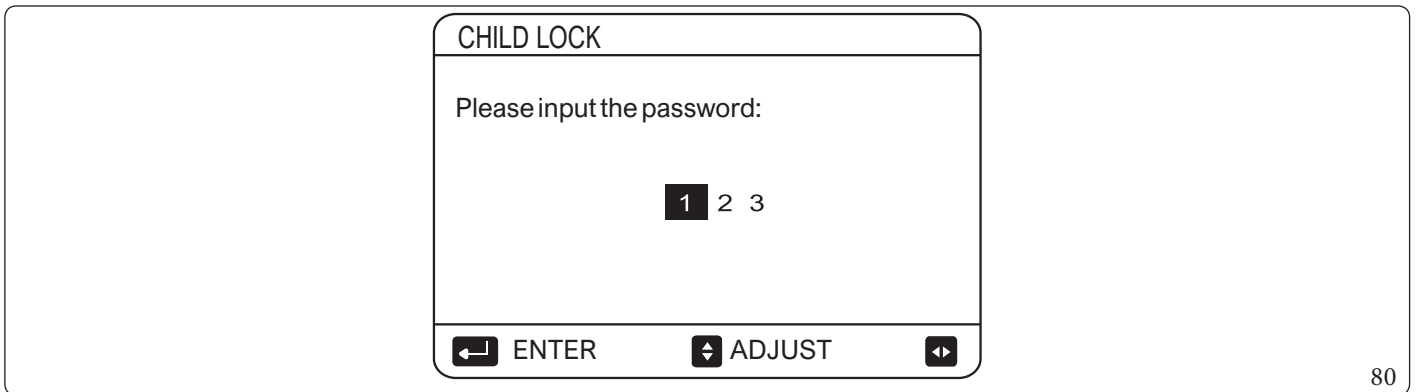

80

Entering the current password will display the following page:

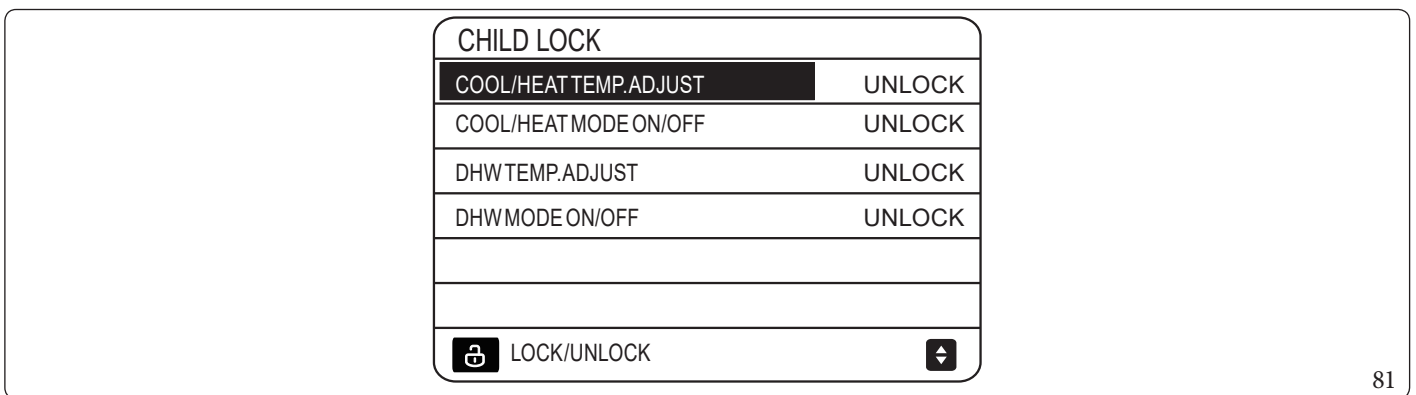

81

Use "▼" and "▲" to scroll and  to select LOCK or UNLOCK (LOCK/UNLOCK). The cooling/heating temperature cannot be adjusted when the "COOL/HEAT TEMP.ADJUST" function is locked. If you wish to adjust the cooling/heating temperature when locked, the following page will appear:

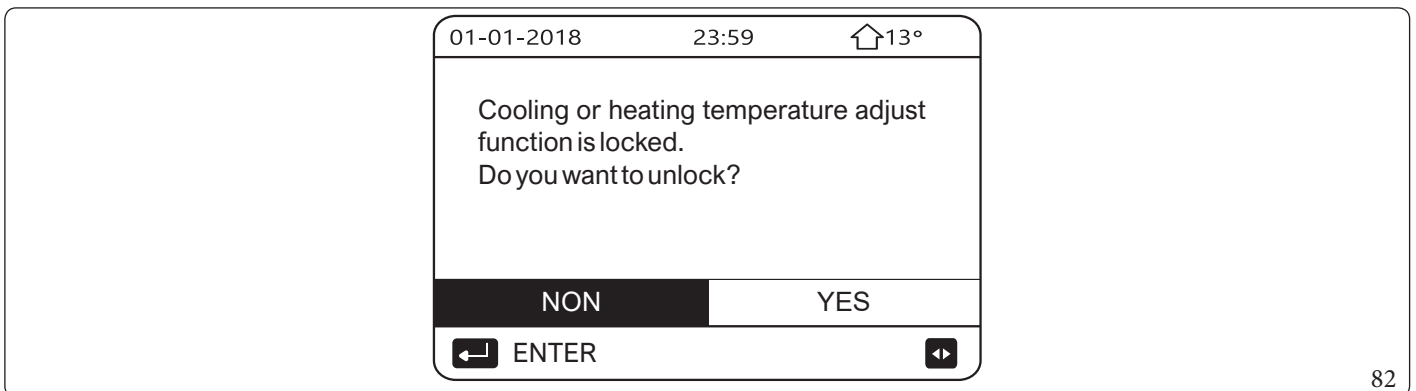

82



The cooling/heating temperature cannot be adjusted when the "COOL/HEAT MODE ON/OFF" function is locked. If you wish to adjust the "COOL/HEAT MODE ON/OFF" temperature when locked, the following page will appear:

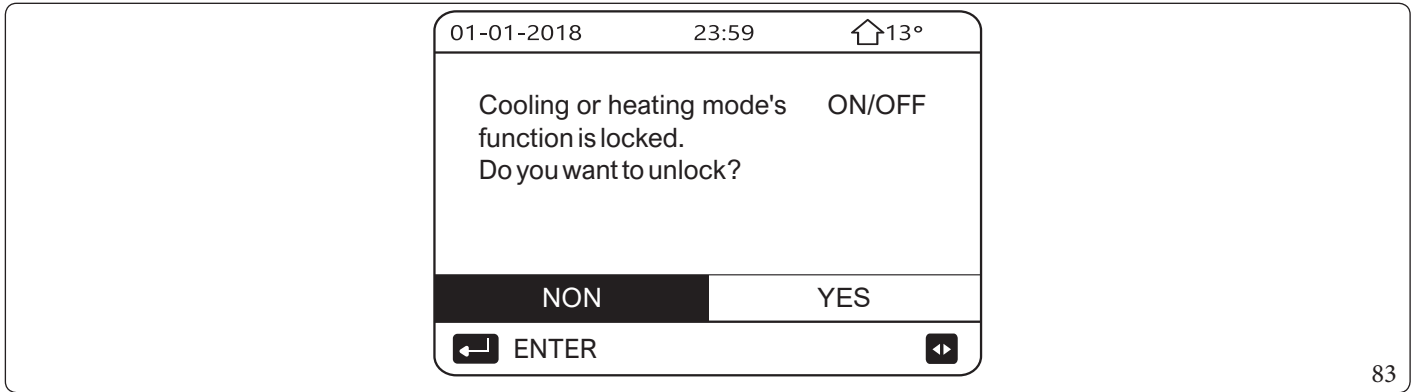

83

It is not possible to adjust the "DHW" temperature when the "DHW TEMP.ADJUST" function is locked. If you try to adjust the "DHW" temperature when the "DHW TEMP.ADJUST" function is locked, the following page will appear:

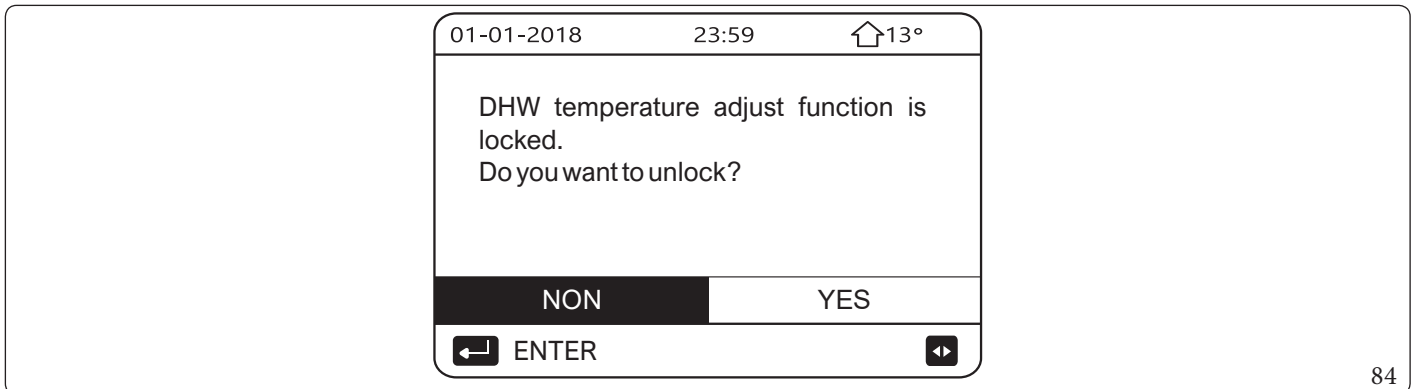

84

The "DHW" mode cannot be activated or deactivated when the "DHW MODE ON/OFF" function is locked. If you try to activate or deactivate "DHW" when the "DHW MODE ON/OFF" function is locked, the following page will appear:

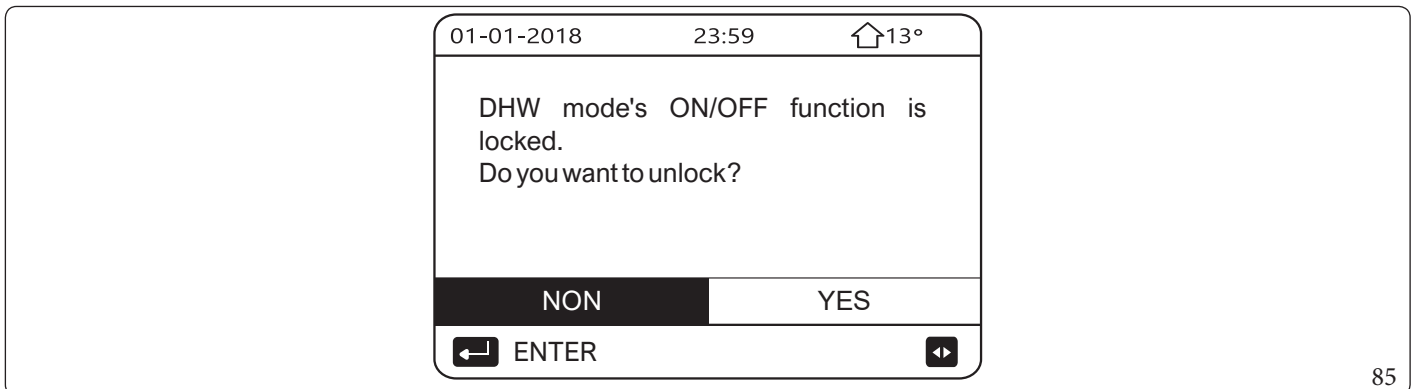

85



## 6.7 TECHNICAL INFORMATION.

### SERVICE INFORMATION

The "SERVICE INFORMATION" menu contains the following items:

- SERVICE CALL;
- ERROR CODE;
- PARAMETER;
- DISPLAY.

#### How to access the "SERVICE INFORMATION" menus.

- Go to "☰" > "SERVICE CALL".
- Press "↩". The following page is displayed:

The service call can contain a phone number or mobile number.

The installer can enter the phone number. See Paragraph 6.9 "For Serviceman."

SERVICE INFORMATION			
SERVICE CALL	ERROR CODE	PARAMETER	DISPLAY
PHONE NO.	000000000000		
MOBILE NO.	000000000000		

86

The "ERROR CODE" menu indicates when a fault or problem occurs and shows the meaning of the error code.

SERVICE INFORMATION			
SERVICE CALL	ERROR CODE	PARAMETER	DISPLAY
E2	#00	14:10	01-01-2018
E2	#00	14:00	01-01-2018
E2	#00	13:50	01-01-2018
E2	#00	13:20	01-01-2018
<input type="button" value="↩"/> ENTER <input type="button" value="⏪"/>			

87

Press "↩". The following page is displayed:

SERVICE INFORMATION			
SERVICE CALL	ERROR CODE	PARAMETER	DISPLAY
E2	#00	14:10	01-01-2018
E2	#00	14:00	01-01-2018
E2	#00	13:50	01-01-2018
E2	#00	13:20	01-01-2018
<input type="button" value="↩"/> ENTER <input type="button" value="⏩"/>			

88





Press  to show the meaning of the error code:

01-01-2018
23:59
🏠 13°

communication fault between controller and indoor unit.

Please contact your dealer.

 ENTER

89





A maximum of eight error codes can be recorded.

The "PARAMETER" function is used to display the main parameters. There are two parameter pages available:

SERVICE INFORMATION
1/2



SERVICE CALL	ERROR CODE	PARAM-ETER	DISPLAY
ROOMSET TEMP.			26°C
MAINSET TEMP.			55°C
TANKSET TEMP.			55°C
ROOMACTUAL TEMP.			24°C

90

SERVICE INFORMATION
2/2

SERVICE CALL	ERROR CODE	PARAM-ETER	DISPLAY
MAINACTUAL TEMP.			26°C
TANKACTUAL TEMP.			55°C





91

The "DISPLAY" function is used to set the control panel:

SERVICE INFORMATION
1/2



SERVICE CALL	ERROR CODE	PARAM-ETER	DISPLAY
TIME			12:30
DATE			08-08-2018
LANGUAGE			EN
BACKLIGHT			ON

 ENTER

92

SERVICE INFORMATION
2/2

SERVICE CALL	ERROR CODE	PARAM-ETER	DISPLAY
BUZZER			ON
SCREENLOCKTIME			120 SEC
SMART GRID RUNNING TIME			2 Hrs

 ON/OFF

93



Use  to enter and , , ,  to scroll.





## 6.8 OPERATION PARAMETERS.





This manual is intended for the installer or service engineer controlling the operating parameters.



- On the home page, go to “” > “OPERATION PARAMETER”.
- Press “”. There are six pages for the operation parameters. Use “” and “” to scroll.

OPERATION PARAMETER	#00
ONLINE UNITS NUMBER	1
OPERATE MODE	COOLING
SV1 STATE	ON
SV2 STATE	OFF
SV3 STATE	OFF
PUMP_I	NON
 ADDRESS	1/9 



94

OPERATION PARAMETER	#00
T5S_H.A_DHW	53°C
Tw2 CIRCUIT2 WATER TEMP.	35°C
T1S' C1 CLI. CURVE TEMP.	35°C
T1S2' C2 CLI. CURVE TEMP.	35°C
TW_OPLATE W-OUTLET TEMP.	35°C
TW_IPLATE W-INLET TEMP.	30°C
 ADDRESS	4/9 



97

OPERATION PARAMETER	#00
FAN SPEED	600 R/MIN
IDU TARGET FREQUENCY	46Hz
FREQUENCY LIMITED TYPE	5
SUPPLY VOLTAGE	230V
DC GENERATRIX VOLTAGE	420V
DC GENERATRIX CURRENT	18A
 ADDRESS	7/9 



100

OPERATION PARAMETER	#00
PUMP_O	OFF
PUMP_C	OFF
PUMP_S	OFF
PUMP_D	OFF
PIPE BACKUP HEATER	OFF
TANK BACKUP HEATER	ON
 ADDRESS	2/9 



95

OPERATION PARAMETER	#00
Tbt1 BUFFERTANK_UP TEMP.	35°C
Tbt_2BUFFERTANK_LOW TEMP.	35°C
Tsolar	25°C
IDU SOFTWARE	01-09-2019V01
 ADDRESS	5/9 



98

OPERATION PARAMETER	#00
TW_OPLATE W-OUTLET TEMP.	35°C
TW_IPLATE W-INLET TEMP.	30°C
T2 PLATE F-OUT TEMP.	35°C
T2B PLATE F-IN TEMP.	35°C
Th COMP. SUCTION TEMP.	5°C
Tp COMP. DISCHARGE TEMP.	75°C
 ADDRESS	8/9 



101

OPERATION PARAMETER	#00
GAS BOILER	OFF
T1 LEAVING WATER TEMP.	35°C
WATER FLOW	1,72m³/h
HEAT PUMP CAPACITY	11,52kW
CONSUMPTION	1000kWh
Ta ROOM TEMP.	25°C
 ADDRESS	3/9 

96

OPERATION PARAMETER	#00
ODU MODEL	6kW
COMP. CURRENT	12A
COMP. FREQUENCY	24Hz
COMP. RUN TIME	54 MIN
COMP. TOTAL RUN TIME	1000Hrs
EXPANSION VALVE	200P
 ADDRESS	6/9 

99

OPERATION PARAMETER	#00
T3 OUTDOOR EXCHANGE TEMP.	5°C
T4 OUTDOOR AIR TEMP.	5°C
TF MODULE TEMP.	55°C
P1 COMP. PRESSURE	2300kPa
ODU SOFTWARE	01-09-2018V01
HMI SOFTWARE	01-09-2018V01
 ADDRESS	9/9 

102



Entering the power consumption parameter is optional.

Parameters not activated in the system are marked “-”.

The heat pump capacity is only indicated as a reference and must not be used to assess the efficiency of the unit.

Sensor accuracy is  $\pm 1^\circ\text{C}$ .

The flow rate parameters are calculated based on the operation parameters of the pump (only for 4-16 kW units).

The deviation changes depending on the flow rates.

The maximum deviation is 15%.



## 6.9 FORSERVICEMAN.

### Information on "FORSERVICEMAN" menu.



The "FOR SERVICEMAN" menu is intended for the installer and service engineer.

- Setting the functions of the appliance.
- Setting the parameters.

### How to access the "FORSERVICEMAN" menu.

Goto " " > "FORSERVICEMAN". Press " ".

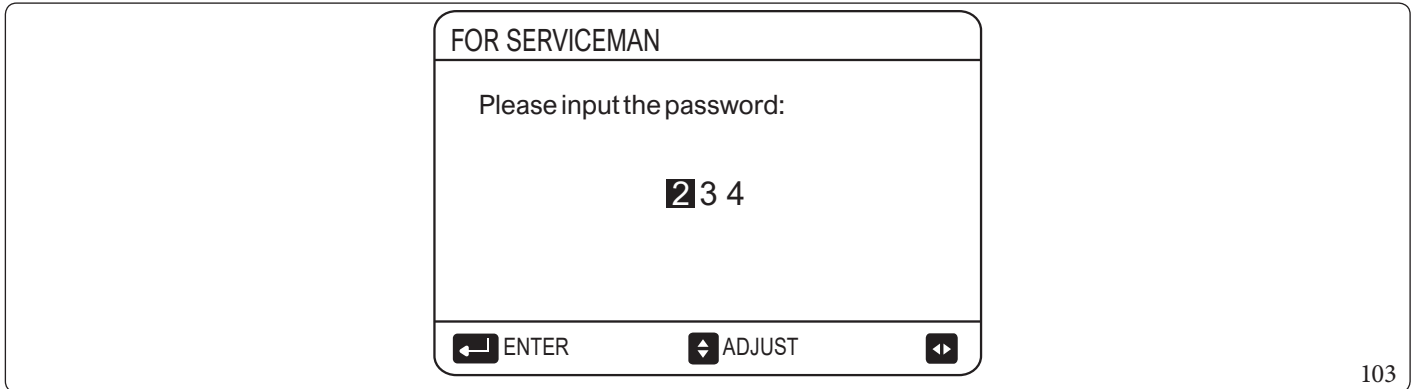

- The "FOR SERVICEMAN" menu is intended for the installer or service engineer. Domestic users must NOT modify the settings through this menu.
- This is why it is protected by password to prevent unauthorised persons from having access to the service settings.
- The password is 234.

### How to exit the "FORSERVICEMAN" menu.

If all the parameters have been set, press " ". The following page is displayed:

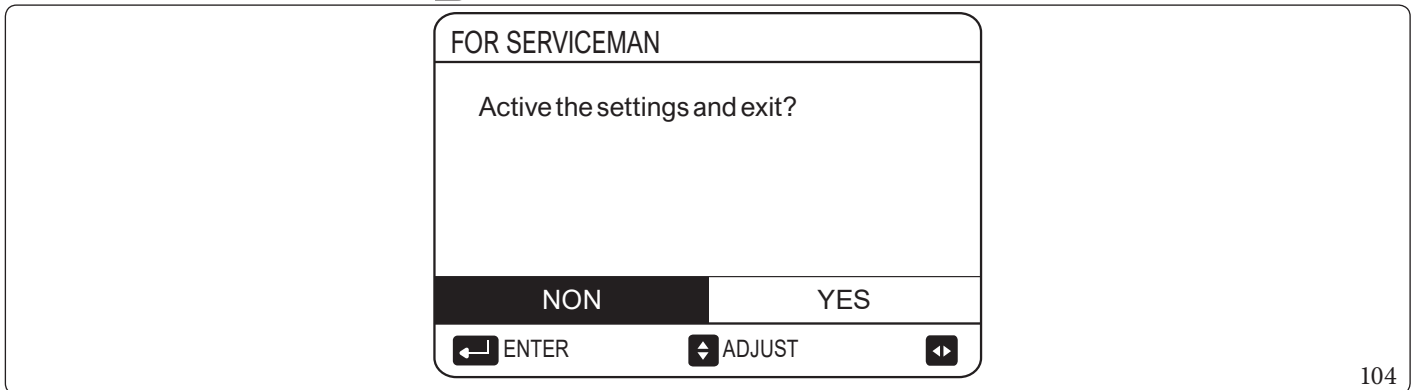

Select "YES" and the press " " to exit the "FORSERVICEMAN" menu.  
After you have exited the menu, the unit shuts down.



## 6.10 SHOWSSN

SN VIEW

---

HMI NO.  
\*\*\*\*\*

---

105

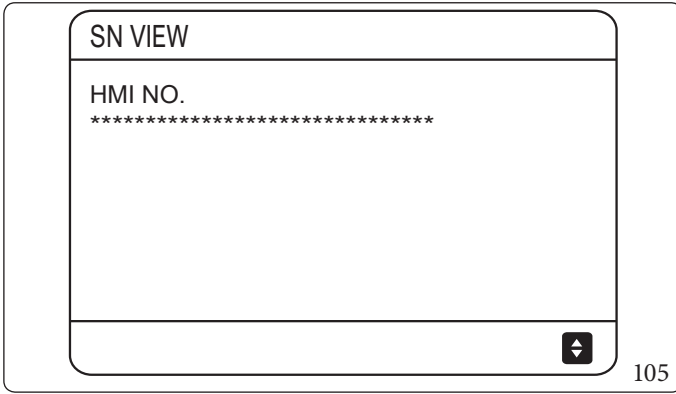

SN VIEW #1

---

IDU NO.  
\*\*\*\*\*

ODU NO.  
\*\*\*\*\*

---

106

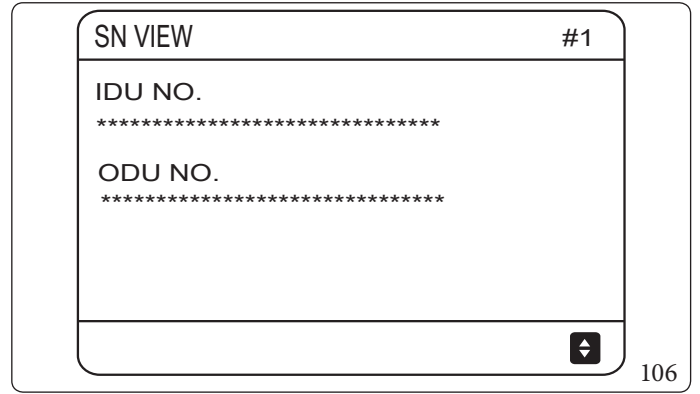



# 7 MENU STRUCTURE: OVERVIEW.

MAINMENU	
OPERATE MODE	
PRESET TEMPERATURE	
DOMESTIC HOT WATER(DHW)	
SCHEDULE	
OPTIONS	
CHILD LOCK	
SERVICE INFORMATION	
OPERATION PARAMETER	
FOR SERVICEMAN	
WLAN SETTING (*)	
SN VIEW	
ENERGY METERING	

(\*) = Application not available.

<b>OPERATE MODE</b>	HEATING
	COOLING
	AUTO

<b>PRESET TEMPERATURE</b>	PRESET TEMP.
	WEATHER TEMP.SET
	WEATHER TEMP.SET

<b>DOMESTIC HOT WATER(DHW)</b>	DISINFECT	CURRENT STATE
	DISINFECT	OPERATED DAY
	DISINFECT	START
	FAST DHW	
	TANK HEATER	
	DHW PUMP	

<b>SCHEDULE</b>	TIMER
	WEEKLY SCHEDULE
	SCHEDULE CHECK
	CANCEL TIMER



<b>OPTIONS</b>	SILENT MODE	CURRENT STATE
		SILENT LEVEL
		TIMER1 START
		TIMER1 END
		TIMER1
		TIMER2 START
		TIMER2 END
		TIMER2
	HOLIDAY AWAY	CURRENT STATE
		13.2 DHW MODE
		DISINFECT
		HEAT MODE
		FROM
		UNTIL
	HOLIDAY HOME	CURRENT STATE
		FROM
UNTIL		
TIMER		
BACKUP HEATER		

<b>CHILDLOCK</b>	COOL/HEAT TEMP.ADJUST
	COOL/HEAT MODE ON/OFF
	DHW TEMP.ADJUST
	DHW MODE ON/OFF

<b>SERVICE INFORMATION</b>	SERVICE CALL	
	ERROR CODE	
	PARAMETER	ROOM SET TEMP.
		MAIN SET TEMP.
		TANK SET TEMP.
		ROOM ACTUAL TEMP.
		MAIN ACTUAL TEMP.
		TANK ACTUAL TEMP.
	DISPLAY	TIME
		DATE
		LANGUAGE
		BACKLIGHT
		BUZZER
		SCREEN LOCK TIME
SMART GRID RUNNING TIME		

<b>OPERATION PARAMETER</b>	<b>OPERATION PARAMETER</b>
----------------------------	----------------------------



<b>FOR SERVICEMAN</b>	1. DHW MODE SETTING
	2. COOL MODE SETTING
	3. HEAT MODE SETTING
	4. AUTO MODE SETTING
	5. TEMP. TYPE SETTING
	6. ROOM THERMOSTAT
	7. OTHER HEATING SOURCE
	8. HOLIDAY AWAY SETTING
	9. SERVICE CALL
	10. RESTORE FACTORY SETTINGS
	11. TEST RUN
	12. SPECIAL FUNCTION
	13. AUTO RESTART
	14. POWER INPUT LIMITATION
	15. INPUT DEFINE
	16. CASCADE SET
	17. HMI ADDRESS SET

<b>WLAN SETTING (*)</b>	Not Used
-------------------------	----------

(\*) = Application not available.

<b>SN VIEW</b>	HMINO.
	IDUNO.
	ODUNO.

<b>ENERGY METERING</b>	HEATING
	COOLING
	DHW



**For Serviceman Menu Overview.**

<b>FOR SERVICEMAN</b>	
<b>1. DHW MODE SETTING</b>	1.1 DHW MODE
	1.2 DISINFECT
	1.3 DHW PRIORITY
	1.4 PUMP_D
	1.5 DHW PRIORITY TIMESET
	1.6 dT5_ON
	1.7 dT1S5
	1.8 T4DHWMAX
	1.9 T4DHWMIN
	1.10 t_INTERVAL_DHW
	1.11 dT5_TBH_OFF
	1.12 T4_TBH_ON
	1.13 t_TBH_DELAY
	1.14 T5S_DISINFECT
	1.15 t_DI_HIGHTEMP
	1.16 t_DI_MAX
	1.17 t_DHWHP_RESTRICT
	1.18 t_DHWHP_MAX
	1.19 PUMP_D TIMER
	1.20 PUMP_D RUNNING TIME
	1.21 PUMP_D DISINFECT RUN

<b>FOR SERVICEMAN</b>	
<b>2. COOL MODE SETTING</b>	2.1 COOL MODE
	2.2 t_T4_FRESH_C
	2.3 T4CMAX
	2.4 T4CMIN
	2.5 dT1SC
	2.6 dTSC
	2.7 t_INTERVAL_C
	2.8 T1SetC1
	2.9 T1SetC2
	2.10 T4C1
	2.11 T4C2
	2.12 ZONE1 C-EMISSION
	2.13 ZONE2 C-EMISSION



FOR SERVICEMAN	
3. HEAT MODE SETTING	3.1 HEAT MODE
	3.2 t_T4_FRESH_H
	3.3 T4HMAX
	3.4 T4HMIN
	3.5 dT1SH
	3.6 dTSH
	3.7 t_INTERVAL_H
	3.8 T1SetH1
	3.9 T1SetH2
	3.10 T4H1
	3.11 T4H2
	3.12 ZONE1 H-EMISSION
	3.13 ZONE2 H-EMISSION
	3.14 t_DELAY_PUMP

FOR SERVICEMAN	
4. AUTO MODE SETTING	4.1 T4AUTO CMIN
	4.2 T4AUTO HMAX

FOR SERVICEMAN	
5. TEMP. TYPE SETTING	5.1 WATER FLOW TEMP.
	5.2 ROOM TEMP.
	5.3 DOUBLE ZONE
	5.4 ENERGY METERING

FOR SERVICEMAN	
6. ROOM THERMOSTAT	6.1 ROOM THERMOSTAT

FOR SERVICEMAN	
7. OTHER HEATING SOURCE	7.1 dT1_IBH_ON
	7.2 t_IBH_DELAY
	7.3 T4_IBH_ON
	7.4 dT1_AHS_ON (Not Used)
	7.5 t_AHS_DELAY (Not Used)
	7.6 T4_AHS_ON (Not Used)
	7.7 IBH LOCATE
	7.8 P_IBH1
	7.9 P_IBH2 (Not Used)
	7.10 P_TBH



<b>FOR SERVICEMAN</b>	
<b>8. HOLIDAY AWAY SETTING</b>	8.1 T1S_H.A_H
	8.2 T5S_H.A._DHW

<b>FOR SERVICEMAN</b>	
<b>9. SERVICE CALL</b>	PHONE NO.
	MOBILE NO.

<b>FOR SERVICEMAN</b>	
<b>10. RESTORE FACTORY SETTINGS</b>	

<b>FOR SERVICEMAN</b>	
<b>11. TEST RUN</b>	

<b>FOR SERVICEMAN</b>	
<b>12. SPECIAL FUNCTION</b>	

<b>FOR SERVICEMAN</b>	
<b>13. AUTO RESTART</b>	13.1 COOL/HEAT MODE
	13.2 DHW MODE



<b>FOR SERVICEMAN</b>	
<b>14. POWER INPUT LIMITATION</b>	14.1 POWER INPUT LIMITATION

<b>FOR SERVICEMAN</b>	
<b>15. INPUT DEFINE</b>	15.1 M1/M2
	15.2 SMART GRID
	15.3 Tw2
	15.4 Tbt1
	15.5 Tbt2 (Not Used)
	15.6 Ta
	15.7 Ta-adj.
	15.8 SOLAR INPUT
	15.9 F-PIPE LENGTH
	15.10 RT/Ta_PCB
	15.11 PUMP_ISILENT MODE
	15.12 DFT1/DFT2

<b>FOR SERVICEMAN</b>	
<b>16. CASCADE SET</b>	16.1 PER_START
	16.2 TIME_ADJUST
	16.3 ADDRESS RESET

<b>FOR SERVICEMAN</b>	
<b>17. HMI ADDRESS SET</b>	17.1 HMI SET
	17.2 HMI ADDRESS FOR BMS
	17.3 STOP BIT



**Table 1**

The room temperature curve of the low temperature setting for heating.

T4	≤-20	-19	-18	-17	-16	-15	-14	-13	-12	-11	-10	-9	-8	-7	-6	-5	-4	-3	-2	-1	0
1-T1S	38	38	38	38	38	37	37	37	37	37	37	36	36	36	36	36	36	35	35	35	35
2-T1S	37	37	37	37	37	36	36	36	36	36	36	35	35	35	35	35	35	34	34	34	34
3-T1S	36	36	36	35	35	35	35	35	35	34	34	34	34	34	34	33	33	33	33	33	33
4-T1S	35	35	35	34	34	34	34	34	34	33	33	33	33	33	33	32	32	32	32	32	32
5-T1S	34	34	34	33	33	33	33	33	33	32	32	32	32	32	32	31	31	31	31	31	31
6-T1S	32	32	32	32	31	31	31	31	31	31	31	31	30	30	30	30	30	30	30	30	29
7-T1S	31	31	31	31	30	30	30	30	30	30	30	30	29	29	29	29	29	29	29	29	28
8-T1S	29	29	29	29	28	28	28	28	28	28	28	28	27	27	27	27	27	27	27	27	26

T4	1	2	3	4	5	6	7	8	9	10	11	12	13	14	15	16	17	18	19	≥20	
1-T1S	35	35	34	34	34	34	34	34	33	33	33	33	33	33	32	32	32	32	32	32	32
2-T1S	34	34	33	33	33	33	33	33	32	32	32	32	32	32	31	31	31	31	31	31	31
3-T1S	32	32	32	32	32	32	31	31	31	31	31	31	30	30	30	30	30	30	29	29	29
4-T1S	31	31	31	31	31	31	30	30	30	30	30	30	29	29	29	29	29	29	28	28	28
5-T1S	30	30	30	30	30	30	29	29	29	29	29	29	28	28	28	28	28	28	27	27	27
6-T1S	29	29	29	29	29	29	28	28	28	28	28	28	27	27	27	27	27	27	26	26	26
7-T1S	28	28	28	28	28	28	27	27	27	27	27	27	26	26	26	26	26	26	25	25	25
8-T1S	26	26	26	26	26	26	26	25	25	25	25	25	25	25	25	24	24	24	24	24	24

**Table 2**

The room temperature curve of the high temperature setting for heating.

T4	≤-20	-19	-18	-17	-16	-15	-14	-13	-12	-11	-10	-9	-8	-7	-6	-5	-4	-3	-2	-1	0
1-T1S	55	55	55	55	54	54	54	54	54	54	54	54	53	53	53	53	53	53	53	53	52
2-T1S	53	53	53	53	52	52	52	52	52	52	52	52	51	51	51	51	51	51	51	51	50
3-T1S	52	52	52	52	51	51	51	51	51	51	51	51	50	50	50	50	50	50	50	50	49
4-T1S	50	50	50	50	49	49	49	49	49	49	49	49	48	48	48	48	48	48	48	48	47
5-T1S	48	48	48	48	47	47	47	47	47	47	47	47	46	46	46	46	46	46	46	46	45
6-T1S	45	45	45	45	44	44	44	44	44	44	44	44	43	43	43	43	43	43	43	43	42
7-T1S	43	43	43	43	42	42	42	42	42	42	42	42	41	41	41	41	41	41	41	41	40
8-T1S	40	40	40	40	39	39	39	39	39	39	39	39	38	38	38	38	38	38	38	38	37

T4	1	2	3	4	5	6	7	8	9	10	11	12	13	14	15	16	17	18	19	≥20	
1-T1S	52	52	52	52	52	52	52	51	51	51	51	51	51	51	51	50	50	50	50	50	50
2-T1S	50	50	50	50	50	50	50	49	49	49	49	49	49	49	49	48	48	48	48	48	48
3-T1S	49	49	49	49	49	49	49	48	48	48	48	48	48	48	48	47	47	47	47	47	47
4-T1S	47	47	47	47	47	47	47	46	46	46	46	46	46	46	46	45	45	45	45	45	45
5-T1S	45	45	45	45	45	45	45	44	44	44	44	44	44	44	44	43	43	43	43	43	43
6-T1S	42	42	42	42	42	42	42	41	41	41	41	41	41	41	41	40	40	40	40	40	40
7-T1S	40	40	40	40	40	40	40	39	39	39	39	39	39	39	39	38	38	38	38	38	38
8-T1S	37	37	37	37	37	37	37	36	36	36	36	36	36	36	36	35	35	35	35	35	35





**Automatic setting curve.**

The automatic setting curve is the ninth; the graph with the parameters to set is displayed below:

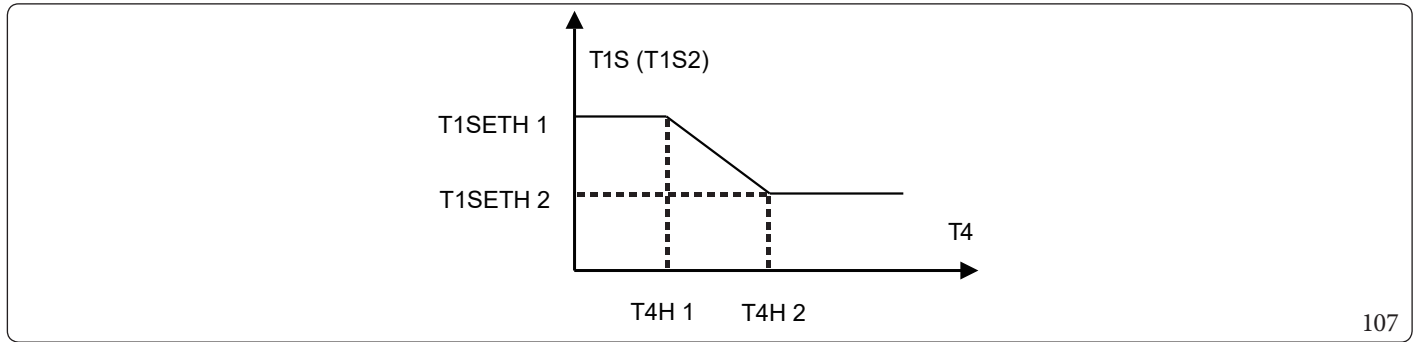

107

State: in the setting of the control panel, if  $T4H2 < T4H1$ , exchange their value; if  $T1SETH1 < T1SETH2$ , exchange their value.

**Table 3**

The room temperature curve of the low temperature setting for cooling.

T4	$-10 \leq T4 \leq 15$	$15 \leq T4 \leq 22$	$22 \leq T4 \leq 30$	$30 \leq T4$
1-T1S	16	11	8	5
2-T1S	17	12	9	6
3-T1S	18	13	10	7
4-T1S	19	14	11	8
5-T1S	20	15	12	9
6-T1S	21	16	13	10
7-T1S	22	17	14	11
8-T1S	23	18	15	12

**Table 4**

The room temperature curve of the high temperature setting for cooling.

T4	$-10 \leq T4 \leq 15$	$15 \leq T4 \leq 22$	$22 \leq T4 \leq 30$	$30 \leq T4$
1-T1S	20	18	17	16
2-T1S	21	19	18	17
3-T1S	22	20	19	17
4-T1S	23	21	19	18
5-T1S	24	21	20	18
6-T1S	24	22	20	19
7-T1S	25	22	21	29
8-T1S	25	23	21	20

**Automatic setting curve.**

The automatic setting curve is the ninth; the graph with the parameters to set is displayed:

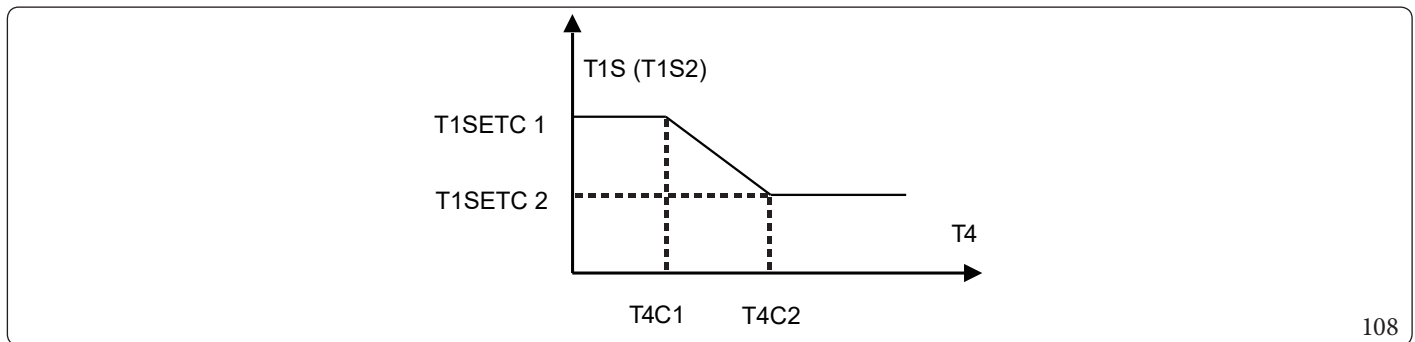

108

State: in the setting of the control panel, if  $T4C2 < T4C1$ , exchange their value; if  $T1SETC1 < T1SETC2$ , exchange their value.







**Immergas S.p.A.**

42041 Brescello (RE) - Italy

Tel. 0522.689011

**immergas.com**

For Technical help or for Service call...

**ALPHA HELPLINE Tel: 0344871 8764**

website: [www.alpha-innovation.co.uk](http://www.alpha-innovation.co.uk)

# Alpha

HEATING INNOVATION

Nepicar House, London Road,  
Wrotham Heath, Sevenoaks,  
Kent TN157RS



This instruction booklet is made of ecological paper.

