

CONDENSING

 **IMMERGAS**



VICTRIX OMNIA

Wall-hung combi
condensing boiler

NEW NEW NEW NEW NEW NEW NEW NEW

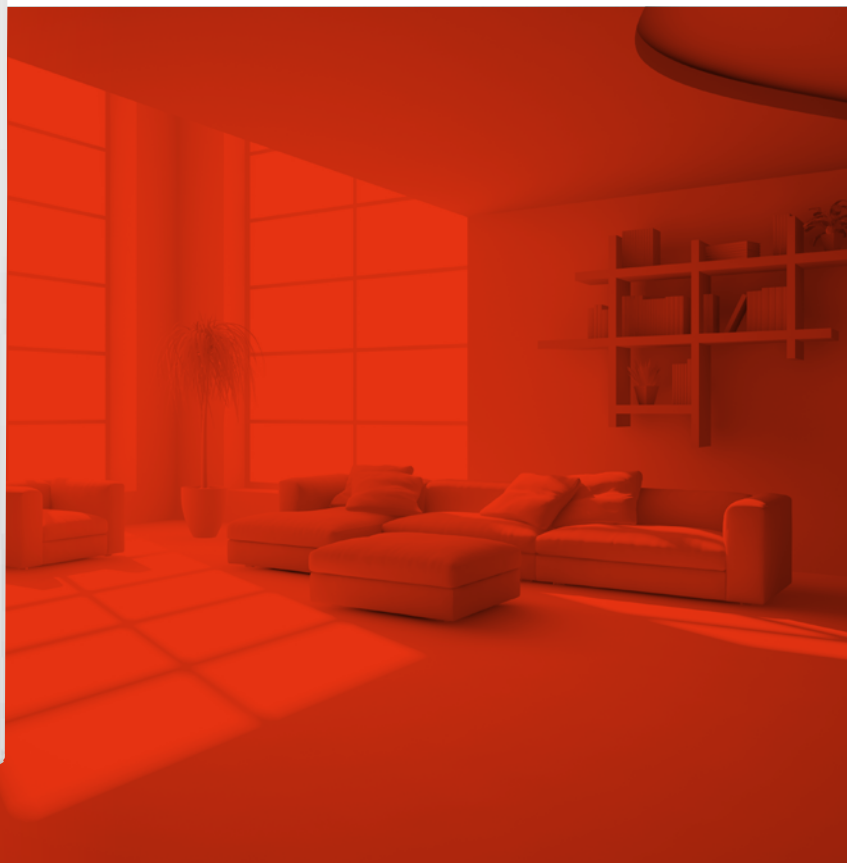

VICTRIX OMNIA

The new unit with DIN fittings, ideal for replacement of old generators

In Europe, there are millions of boilers approaching replacement time and most of them feature DIN type fittings.

That is why Immergas has created VICTRIX OMNIA: **the boiler with the same DIN-type plumbing and gas fittings as the old generators**, which makes installation easier, reduces assembly time and offers a very good quality/price ratio.

Designed to comply with European Directives on energy use, VICTRIX OMNIA is an excellent fully premixing boiler equipped with stainless steel coil condensing unit.

Thanks to its **extremely compact size** it offers a large range of installation solutions: indoor, recessed and outdoor in partially protected places.

Like all Immergas condensing boilers, VICTRIX OMNIA is certified in **class A**.



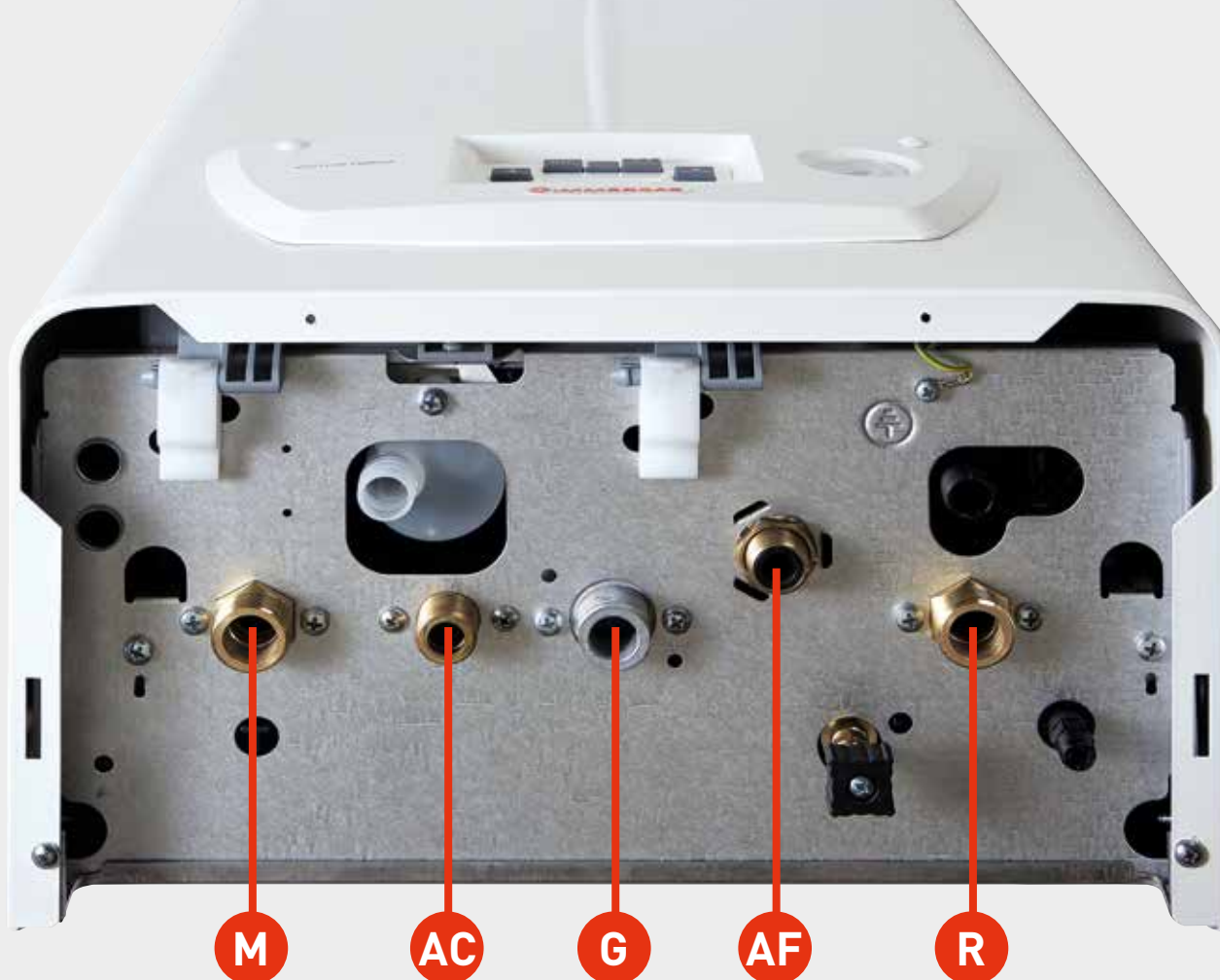

DIN-TYPE FITTINGS FOR EASY, CLEAN INSTALLATION

Thanks to the sequence of DIN connections, our VICTRIX OMNIA boiler is easy to install when replacing obsolete boilers that have high consumption levels.

DIN connections are characterized by the **central "G" fitting** between supply and return connections to the heating system (M-R) and to the water supply system (connection to the water mains AF and domestic hot water supply to household units AC).

MAIN PRODUCT PLUS

Nominal heat output 20,2 kW (C.H. mode) - 25,0 kW (D.H.W. mode)

Dimensions (H x W x D) 738 x 400 x 235 mm

High seasonal efficiency modulating heat output from 20 to 100%

Significant energy savings thanks to the low-consumption pump

Class 6, the best for reduced emissions of nitrogen oxides (NOx)

High hydraulic performance thanks to the low pressure losses of the condensing module

Gas adaptive technology by means an electronic gas valve and a multifunction electrode





HIGH HYDRAULIC PERFORMANCE

The condensing module that equips VICTRIX OMNIA is made with a **single-pipe exchange coil in stainless steel**. The absence of manifolds and circuit in parallel ensures **high reliability** and the reduced number of welds means reduced risk of leaks.

The single stainless steel spiral without narrowing allows a **perfectly balanced hydraulic flow, greatly reducing pressure losses**. The **internal section, wide and constant, limits deposits and reduces the risk of obstructions** in case of impurities in the water (for example in case of replacement of gas boilers in old heating systems). Also for this **VICTRIX OMNIA is ideal for replacement**.

CLASS "A" CIRCULATOR

The low consumption circulator allows for **significant energy savings** compared to traditional circulators. The presence of two supply and return NTC sensors make it possible to continuously modulate operating conditions to the system's demand, **increasing seasonal efficiency**. The circulator can be set to the following operating modes: **Constant Δt , Proportional head or Constant Speed**.

ELECTRONIC AIR/GAS CONTROL

The electronic gas valve enables **air/gas control** by means of a multifunction electrode housed inside the combustion chamber; **the electronic board self-adapts combustion parameters** in case of variations in the density of air or fuel. Another important feature is that nozzles do not need to be replaced if gas is changed (methane/LPG): the boiler is supplied as a **single product code** and you simply need to make adjustments in the electronic board software.

.01



INDOOR AND OUTDOOR INSTALLATION

VICTRIX OMNIA is **approved for outdoor installation provided it is partially protected** from the weather (rain and snow), for example by installing it under a balcony. An electrical resistance kit is available to expand antifreeze protection from $-5\text{ }^{\circ}\text{C}$ to $-15\text{ }^{\circ}\text{C}$ (code 3.017324). The cover kit for direct air suction is available as option (code 3.028415). **NEW**

.01

HYBRID SYSTEMS SOLUTIONS

VICTRIX OMNIA can be installed in TRIO V2/TRIO MONO V2 solutions. Prearranged to combine different energy sources: condensing boilers, air-water heat pumps AUDAX, solar thermal, they allow to increase energetic performances of buildings and disfrut renewable sources reducing harmful emissions. Hybrid systems as TRIO V2 are suitable up to three-roomed housing units. They can be installed in the recessed frame SOLAR CONTAINER or directly inside the home in the special technical box DOMUS CONTAINER, both saving space. The bracket to support the gas boiler comes inserted as standard inside the specific kit to combine AUDAX and VICTRIX OMNIA (code 3.028657).



Technical data	Unit of measurement	VICTRIX OMNIA
Code		3.028358
Maximum nominal heat input (D.H.W. mode)	kW	25,7
Maximum nominal heat input (C.H. mode)	kW	20,8
Minimum nominal heat input	kW	4,2
Maximum nominal heat output (D.H.W. mode)	kW	25,0
Maximum nominal heat output (C.H. mode)	kW	20,2
Minimum nominal heat output	kW	4,1
Effective thermal efficiency 80/60 Nom./Min.	%	97,1/96,5
Weighted CO with natural gas	mg/kWh	23
Weighted NO _x with natural gas	mg/kWh	36
NO _x Class		6
D.H.W. flow rate for continuous service (Δt= 30 °C)	l/min	12,5
D.H.W. circuit max pressure	bar	0,3
Set heating temperature	°C	20 - 85
Central heating expansion vessel nominal capacity (total)	litres	8 (5,8)
Fan available head	Pa	2
Electric protection index	IPX	5D
Full appliance weight (empty)	kg	31,0 (29,0)

VICTRIX OMNIA

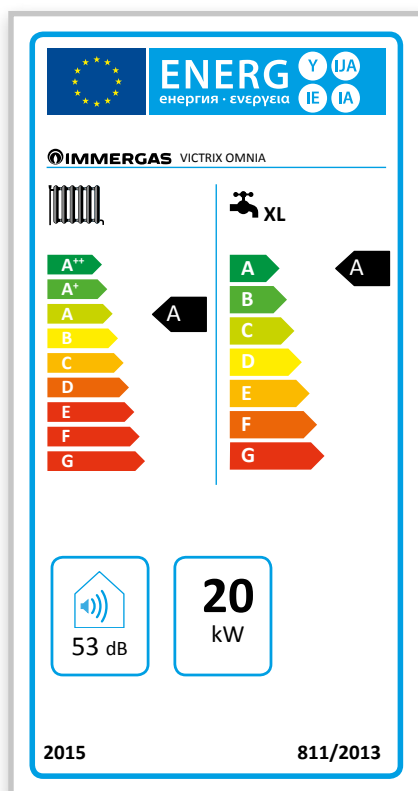

In accordance with the ELD directive (in conformity with regulation 811/2013), we include the label of each water heater to enable customers to evaluate the products. The labels are shown in the documentation accompanying the units as well as on the immergas.com website in each product's page.

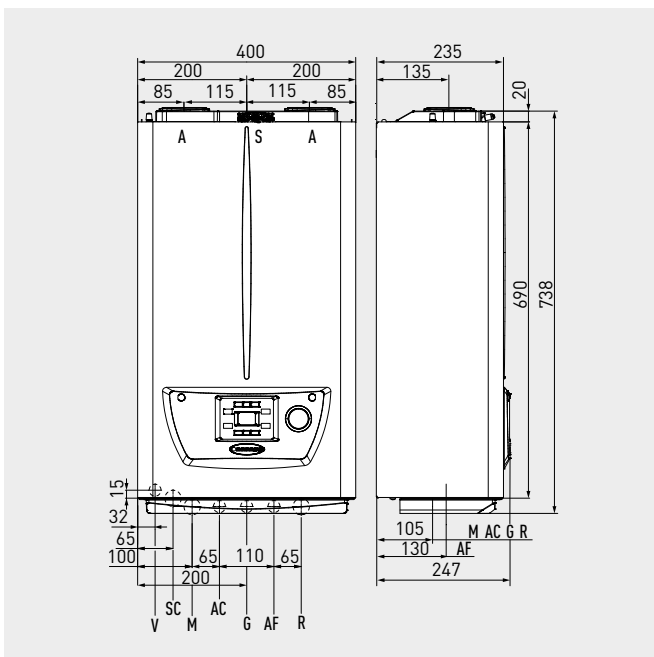

Key

- V Electrical connection
- G Gas supply
- AC Domestic hot water outlet
- AF Domestic cold water inlet
- SC Condensate drain (minimum internal diameter Ø 13 mm)
- M System flow (options)
- R System return (options)
- A/S Inlet/Outlet
- A Inlet
- S Outlet

Hydraulic connections

System	D.H.W.	Gas	D.H.W.	System
M	AC	G	AF	R
¾"	½"	¾"	½"	¾"

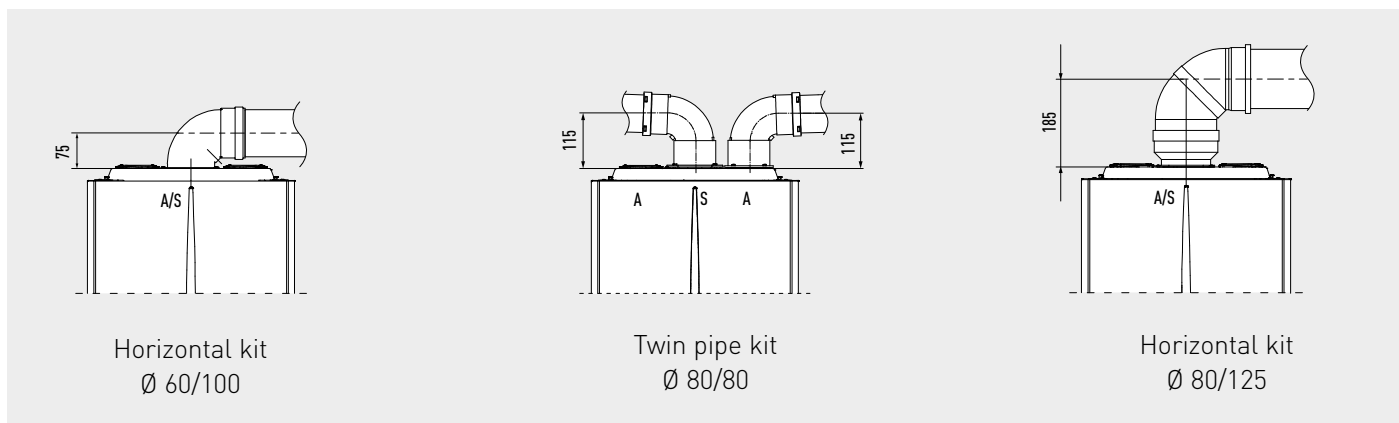

To ensure correct installation of the appliance, the air inlet/flue outlet pipes kit must be selected from the Immergas "Green Series flue systems". **It's available a new option kit: COVER KIT FOR DIRECT AIR SUCTION (code 3.028415 - NEW)**

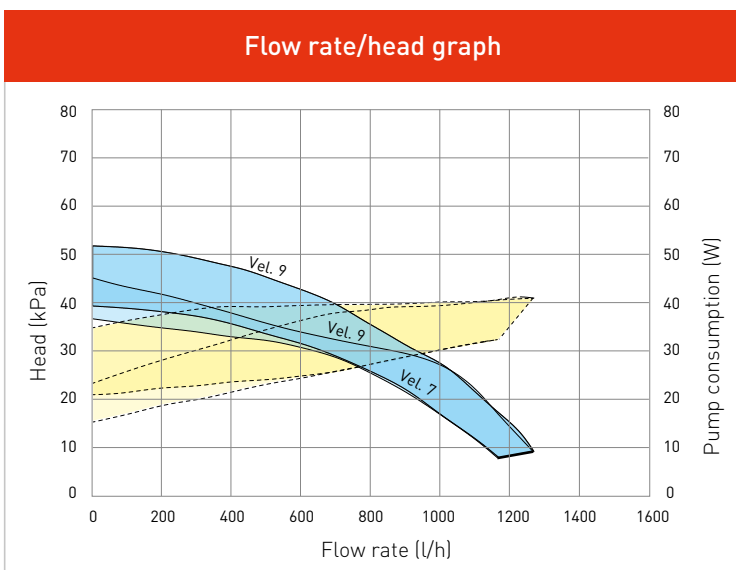

Key

- Available head with by-pass closed;
- Available head with by-pass open;
- Power absorbed by the pump with by-pass open (dotted area);
- Power absorbed by the pump with by-pass closed (dotted area);

VICTRIX OMNIA boiler is equipped with adjustable system by-pass.





Combining VICTRIX OMNIA range with an heat regulation device is an excellent investment because it improves the seasonal energy efficiency of the heating system. For each of the following heat regulation devices we therefore indicate a class, which gives you the percentage value of increased efficiency.

CAR^{V2} (Weekly thermostat and modulating remote control)

Type		Code
Modulating thermostat with remote boiler controls; includes special functions such as antifreeze temperature settings and anti-legionella function (only for boilers with DHW storage tank) IDEAL FOR REPLACEMENT Product class V* or VI Seasonal energy efficiency value 3%* or 4%	 Dimensions (H x W x D) mm 103 x 142 x 31	3.021395

CAR^{V2} WIRELESS (Weekly thermostat and modulating remote control wireless)

Wireless modulating thermostat with remote boiler controls; includes special functions such as antifreeze temperature settings and anti-legionella function (only for boilers with DHW storage tank) Product class V* or VI Seasonal energy efficiency value 3%* or 4%	 Dimensions (H x W x D) mm 103 x 142 x 31  Dimensions (H x W x D) mm 82 x 105 x 26	3.021623
--	---	----------

CRONO 7 (Weekly digital chronothermostat)

Weekly digital chronothermostat Product class IV* or VII Seasonal energy efficiency value 2%* or 3,5%	 Dimensions (H x W x D) mm 103 x 142 x 31	3.021622
---	---	----------

CRONO 7 WIRELESS (Weekly digital chronothermostat wireless)

Wireless weekly digital chronothermostat Product class IV* or VII Seasonal energy efficiency value 2%* or 3,5%	 Dimensions (H x W x D) mm 103 x 142 x 31  Dimensions (H x W x D) mm 82 x 105 x 26	3.021624
--	---	----------

MINI CRD (MINI weekly thermostat and modulating remote control)

Compact modulating thermostat Note: it can be installed only for single zone systems and without an external probe or DOMINUS interface board kit Product class V* or VI Seasonal energy efficiency value 3%* or 4%	 Dimensions (H x W x D) mm 80 x 80 x 23	3.020167
--	---	----------

* Product class with default settings. Some heat regulation device can change class depending on the settings and operation modes that can be changed, for example Modulating or ON/OFF, The use of these devices contributes, in percentage, to the seasonal energy efficiency of the heating system.

External probe

Type		Code
Allows at the boiler to functioning at a variable temperature according to the climatic conditions IDEAL FOR REPLACEMENT Product class II*, VI or VII Seasonal energy efficiency value 2%*, 4% or 3,5%		3.014083

Telephonic remote control

For buildings equipped with telephone network. It can be combined with all Immergas thermoregulation devices except MINI CRD.		Dimensions (H x W x D) mm 85 x 85 x 31	3.013305
--	--	---	----------

GSM Telephonic control

For buildings not equipped with telephone network. It can be combined with all Immergas thermoregulation devices except MINI CRD.		Dimensions (H x W x D) mm 198 x 78 x 30,5	3.017182
--	---	--	----------

Multi-zone electronic board

It can manage 4 zones at the same temperature or 1 mixed and 1 direct zone by remote modulating controls (ie. CAR ^{®2}).			3.028444
--	--	--	----------

Mixing valve kit

For multi-zone electronic board.			3.027084
----------------------------------	--	--	----------

Low temperature safety thermostat kit

For generators set up with low temperature			3.019229
--	--	--	----------

DOMINUS interface board kit

To remote the control of the boiler with DOMINUS APP			3.026273
--	--	--	----------

* Product class with default settings. Some heat regulation device can change class depending on the settings and operation modes that can be changed, for example Modulating or ON/OFF, The use of these devices contributes, in percentage, to the seasonal energy efficiency of the heating system.



Among the wide range of options it is possible to find out any specific accessory to complete the installation of VICTRIX OMNIA. The use of original kits enhances quality and reliability of the products.

Magnetic cyclone filter kit

Type		Code
<p>Important in case of boiler replacement in order to restrain possible ferrous residues. IDEAL FOR REPLACEMENT</p> <p>Easy to inspect and clean, since the system emptying is not needed. Only for indoor installation</p>		3.024176

Condensate discharge pump kit

<p>Usefull in case of counterslope between siphone and discharge; installation externally to the boiler IDEAL FOR REPLACEMENT</p>		3.026374
--	--	----------

Bottom cover kit for condensing boilers **NEW**

<p>Aesthetic frame (240 mm height) that covers connections zone and the main option kits for wall-hung condensing boilers IDEAL FOR REPLACEMENT</p>		3.028656
--	--	----------

Condensate neutralizer kit

<p>Necessary to neutralize the acidity of the condensation if it isn't blended with other domestic waste. Inclusive of granulate. Pre-arranged for internal installations IDEAL FOR REPLACEMENT</p>		3.019857
--	--	----------

Anti-freeze protection kit

<p>Until -15 °C</p>		3.017324
---------------------	--	----------

Shut off knobs

<p>Shut off knobs 3/4"</p>		3.5324
----------------------------	--	--------

Antiscale kit

Type		Code
Approved for installation inside the building		3.013860

Connection kit

Connection kit for new installations		3.015229
Connection kit for replacement		3.011667

Cover kit NEW

For external installations, in partially protected places		3.028415
---	--	----------

VICTRIX OMNIA range can be connected to the DIM Range (Multysystem distribution manifolds). DIM can be connected considering that it's possible to manage zones only with CRONO 7 (no CAR¹²).





App Immergas TOOLBOX

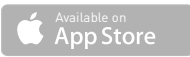

immergas.com

Immergas S.p.A.
42041 Brescello (RE) - Italy
T. 0522.689011
F. 0522.689178



IMMERGAS
IMMERGAS SPA - ITALY
CERTIFIED COMPANY
UNI EN ISO 9001:2015

Design, manufacture and post-sale assistance of gas
boilers, gas water heaters and related accessories