

CONDENSING

 **IMMERGAS**



NEW RANGE

VICTRIX EXA ErP RANGE

Wall-hung combi and
only-heating condensing boiler



WE ARE READY TO DO OUR BIT FOR THE ENVIRONMENT

We are talking about a very important European Union directive, an effective strategy that will drive to in reduced pollution and therefore improve the life of citizens all over Europe. The ErP Directive (2009/125/CE) - the acronym stands for "**Energy Related Products**" - assesses very precise guidelines for design and the manufacturing of eco-compatible products and defines the minimum mandatory requirements for the efficiency and environmental performance of all power-consuming devices.

The goal is to reach the famous 20-20-20 by 2020. The repetition of the number 20 makes it easier to remember the **three key targets of the directive**:

- **INCREASE THE EFFICIENCY OF ENERGY USING APPLIANCES BY 20%**
- **REDUCE THE EMISSION OF CARBON DIOXIDE (CO₂) IN THE ATMOSPHERE BY 20%**
- **RAISE THE PERCENTAGE OF RENEWABLE ENERGY ON FINAL CONSUMPTION TO 20%**

Two deadlines have been set to establish a road map for the adjustment.

Starting from **1 AUGUST 2015** it will be mandatory **to place on the market** appliances fitted with energy efficient circulators.

Starting from **26 SEPTEMBER 2015** the ErP and ELD Directives will enter into force requiring energy labelling of all the appliances **placed on the market**.

Placing on the market means the first time the product is invoiced by Immergas to the dealer. If an appliance is placed on the market before 1 August/26 September 2015, **it can be sold, installed and put into service without time limits**. The ErP and ELD regulations are not retroactive.





Supplier indication

Space heating function

Energy efficiency class related to space heating function

Sound power level related to heating function

Model indication

Domestic hot water production function
Load profile

Energy efficiency class related to domestic hot water function

Space heating power consumption

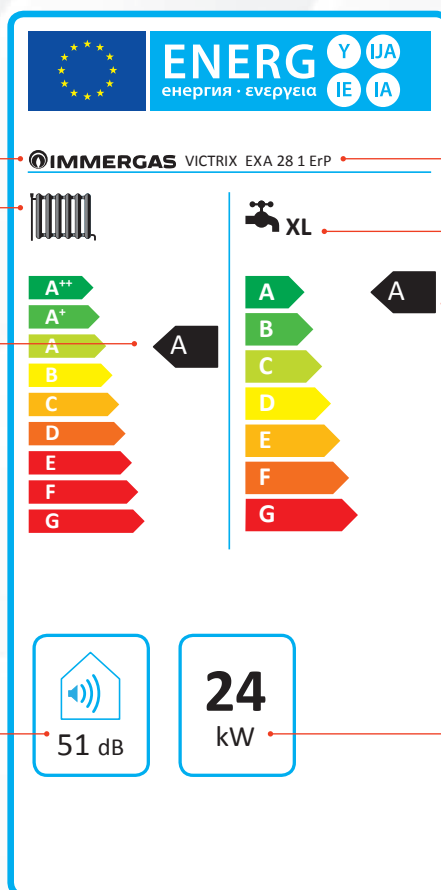

ELD: EVERYTHING CLEAR IN THE LABEL

The European Union has made the new energy labelling system mandatory to enable consumers to see immediately the level of environmental compatibility of every single product. The Energy Labelling Directive (2010/30/CE) requires every product subject to the ErP Directive to bear a label highlighting not only the energy efficiency class but also other performance factors such as sound power level, use and power consumption.

IMMERGAS WELCOMES THESE ADJUSTMENTS WITH PARTICULAR CONVICTION, IN THE KNOWLEDGE THAT ONLY A MARKET THAT STIMULATES TECHNOLOGY WITH THE HIGHEST ENERGY EFFICIENCY CAN BE RESPECTFUL OF THE ENVIRONMENT.

VICTRIX EXA ErP RANGE

Efficiency and simplicity for lots of savings

The VICTRIX EXA ErP range offers **all the advantages of condensation together with total simplicity of use**. Boasting the technology most compatible with the new European Directives and with the aim of reducing energy consumption, it is the most effective solution for many new installations and replacements of existing systems.

VICTRIX EXA ErP are available in two 28 and 32 kW instant versions and in a 24 kW model for heating only, all capable of contributing substantially to **raising the energy efficiency** class for heating.

Wall installation can be **indoors** and **outdoors in partially protected places**. The strengths of the range are the **reliability** and **quality of the stainless steel condensing module** and the performance of the **low-consumption pump**. Its **compact size** makes it convenient and easy to install.

The easy-to-use user interface has adjustment knobs, selection buttons and LCD display showing the operating status and any error codes. The **lower panel covering the connection pipes comes with the range**, while the connection kit is optional for all the models.





DOMINUS. THE APP FOR ONLINE BOILER CONTROL

VICTRIX EXA ErP can be remotely controlled by means of the new DOMINUS app (**available from December 2015**).

This simple, intuitive app lets you control your boiler and display operation data on your tablet, smartphone and portable PC.

Using the optional Wi-Fi transmitter kit (code no. 3.026273), installed before your modem/ router wireless (not supplied by Immergas), you can communicate with the boiler's circuit board from any location.

ADVANTAGES OF DOMINUS APP

- ▶ Intuitive navigation and simple use on smartphone and tablet touchscreens
- ▶ Remote control with direct access to main system settings, such as:
 - Operation status
 - Heating/DHW temperature setting
 - Ambient temperature
 - Reception of error messages
 - Generator resetting
- ▶ Accessible for use anywhere at any time
- ▶ Easy installation
- ▶ Encrypted security access



THE QUALITY OF STAINLESS STEEL

The stainless steel condensing module **ensures durability, high reliability and resistance** to the formation of condensate from cooling of the combustion products.

SIMPLICITY OF CONTROLS

The boiler has a highly-developed easy-to-use user interface with LCD display, selection buttons and adjustment knobs that allow for quick and easy temperature adjustments.

ECOLOGICAL BOILER

Reduced emissions of carbon monoxide (CO) and nitrogen oxides (NOx) results in VICTRIX EXA ErP **being rated class 5, the most ecological** one in the classification by European standards UNI EN 297 and UNI EN 483.

CLASS A CIRCULATOR

The low-consumption pump allows for significant energy savings in comparison with the traditional circulator and self-adjusts in response to flow rate fluctuations, for example when there are thermostatic valves or zone valves.



INDOOR AND OUTDOOR INSTALLATION

VICTRIX EXA ErP is **approved for outdoor installation provided it is partially protected** from the weather (rain and snow), for example by installing it under a balcony. An electrical resistance kit is available to expand antifreeze protection from -5 °C to -15 °C (cod. 3.017324).

VERSION "X"

VICTRIX EXA 24 X ErP, **can be combined with a separate storage tank unit** through a special optional kit (code 3.024907). The kit consists of 2 pipes to connect the three-way valve (standard in the boiler) at separate storage tank. The separate storage tank Units come in a range of models from 80 to 300 litres, to be selected according to the system requirements of domestic hot water production.

STAND-BY LOW POWER CONSUMPTION (LESS THAN 6 W)





VICTRIX EXA 28/32/24 X ErP

Wall-hung combi and only-heating condensing boiler

MAIN CHARACTERISTICS

Available 28 and 32 kW **combi version** and 24 kW **heating-only version**

Ecofriendly - low NOx emissions (class 5)

LCD display

Modulating heat output from 25 to 100%

Low consumption modulating pump

Adjustable system by-pass

Possible **installation outdoors in partially protected areas**

Standard **frost protection to -5 °C** expandable to -15 °C with optional kit

Green Series flue systems

Optional hydraulic connection group

Storage tank connection kit for “X” models

Equipped as standard with the **lower aesthetic casing**

Same hydraulics and gas connection positions as current models



| Technical data | Unit of measurement | VICTRIX EXA 28 1 ErP | VICTRIX EXA 32 1 ErP | VICTRIX EXA 24 X 1 ErP |
|--|------------------------|---------------------------------|---------------------------------|---------------------------------|
| Code | N.G. L.P.G. | 3.025778 3.025778GPL | 3.025779 3.025779GPL | 3.025780 3.025780GPL |
| CE certificate | | 0051CQ4576 | 0051CQ4576 | 0051CQ4576 |
| Maximum nominal heat input (C.H. mode) | kW | 24,2 | 28,4 | 24,2 |
| Maximum nominal heat input (D.H.W. mode) | kW | 28,4 | 32,5 | 24,2 |
| Minimum nominal heat input | kW | 5,7 | 7,4 | 5,7 |
| Maximum nominal heat output (C.H. mode) | kW | 23,7 | 28,0 | 23,7 |
| Maximum nominal heat output (D.H.W. mode) | kW | 27,7 | 32,0 | 23,7 |
| Minimum nominal heat output | kW | 5,5 | 7,2 | 5,5 |
| Efficiency at nominal heat output (80/60 °C) | % | 98,1 | 98,6 | 98,1 |
| Efficiency at 30% of load (80/60 °C) | % | 102,0 | 101,1 | 102,0 |
| Efficiency at nominal heat output (40/30 °C) | % | 107,2 | 109,0 | 107,2 |
| Efficiency at 30% of load (40/30 °C) | % | 107,7 | 108,0 | 107,7 |
| Weighted CO with natural gas | mg/kWh | 41,0 | 27,0 | 41,0 |
| Weighted NO _x with natural gas | mg/kWh | 45,0 | 36,0 | 45,0 |
| D.H.W. flow rate for continuous service (Δt=30 °C) | l/min | 13,5 | 15,3 | - |
| D.H.W. circuit max pressure | bar | 10,0 | 10,0 | - |
| Set heating temperature | °C | 20 - 85 | 20 - 85 | 20 - 85 |
| Central heating circuit max pressure | bar | 3 | 3 | 3 |
| Central heating expansion vessel capacity | litres | 8 | 8 | 8 |
| Fan available head (max/min) | Pa | 145/76 | 225/80 | 145/76 |
| Electric protection index | IPX | 5D | 5D | 5D |
| Full appliance weight | kg | 40,4 | 42,1 | 39,0 |

**Flow rate/head graph
VICTRIX EXA 28/32 ErP - 24 X ErP**

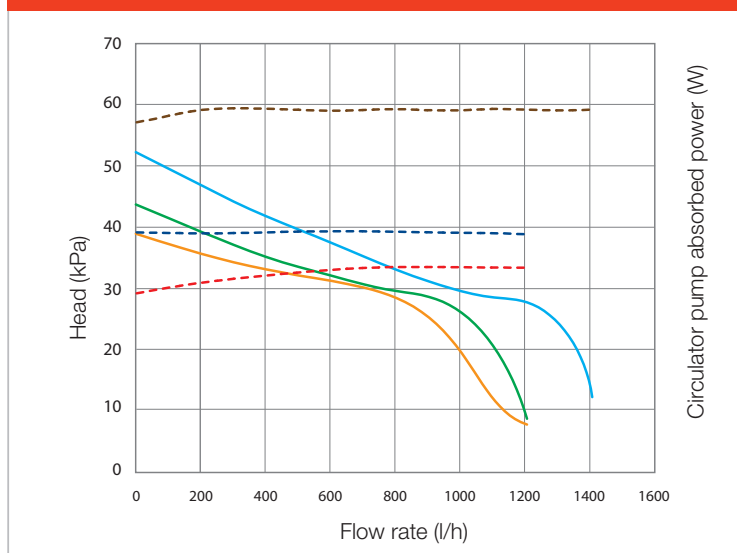

Key:

- Available head for central heating at 2nd speed with inserted by-pass
- Available head for central heating at 3rd speed with inserted by-pass **(default for VICTRIX EXA 28 ErP and VICTRIX EXA 24 X ErP)**
- Available head for central heating at 4th speed with inserted by-pass **(default for VICTRIX EXA 32 ErP)**
- - - Pump consumption at 2nd speed with inserted by-pass
- - - Pump consumption at 3rd speed with inserted by-pass **(default for VICTRIX EXA 28 ErP and VICTRIX EXA 24 X ErP)**
- - - Pump consumption at 4th speed with inserted by-pass **(default for VICTRIX EXA 32 ErP)**



PRODUCT INFORMATION (in accordance with regulation 811/2013)

In accordance with the ELD Directive, we include the label of each boiler to enable customers to evaluate the products. The labels are shown in the documentation accompanying the units as well as on the Immergas.com website in each product's page.

VICTRIX EXA 28 1 ErP

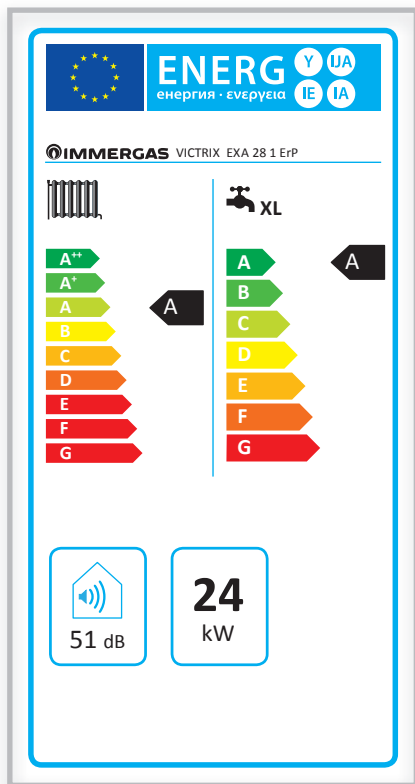

VICTRIX EXA 32 1 ErP

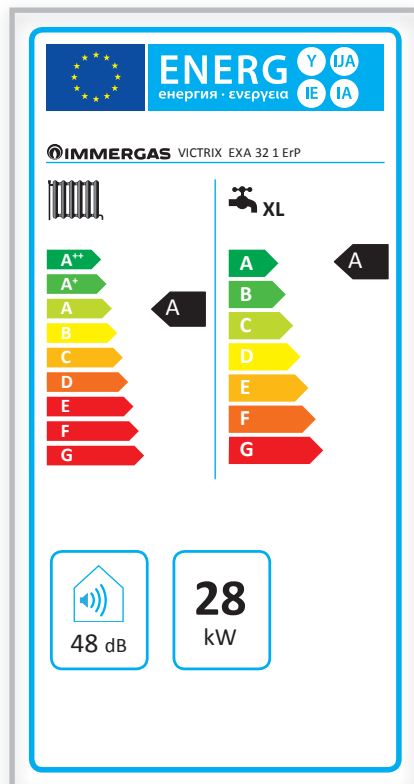

VICTRIX EXA 24 X 1 ErP

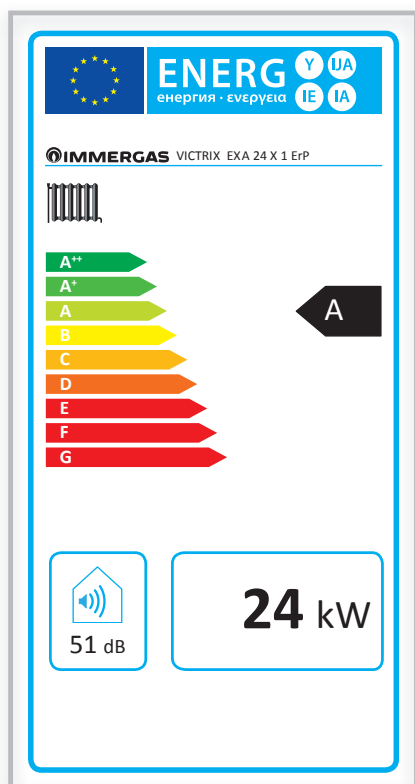

CLIMATIC REGULATION

Combining the VICTRIX EXA ErP range with a heat regulation device is an excellent investment because it improves the seasonal energy efficiency of the heating system. For each of the following heat regulation devices we therefore indicate a class, which gives you the percentage value of increased efficiency.

↘ CAR^{V2} (Modulating remote control)

| Type | | Code |
|---|---|----------|
| <p>Modulating thermostat with remote boiler controls; includes special functions such as antifreeze temperature settings and anti-legionnaire function (only for boilers with DHW storage tank)</p> <p>Product class V* or I Seasonal energy efficiency value 3%* or 1%</p> |  <p>Dimensions (H x W x D) mm 103 x 142 x 31</p> | 3.021395 |

↘ CAR^{V2} WIRELESS (Modulating remote control)

| | | |
|---|---|----------|
| <p>New-generation wireless modulating thermostat with remote boiler controls; includes special functions such as antifreeze temperature settings and anti-legionnaire function (only for boilers with DHW storage tank)</p> <p>Product class V* or I Seasonal energy efficiency value 3%* or 1%</p> |  <p>Dimensions (H x W x D) mm 103 x 142 x 31</p> <p>Dimensions (H x W x D) mm 82 x 105 x 26</p> | 3.021623 |
|---|---|----------|

↘ MINI CRD (Mini Digital Remote Control)

| | | |
|--|---|----------|
| <p>Compact modulating thermostat</p> <p>Note: it can be installed only for single zone systems and without an external probe or DOMINUS interface board kit</p> <p>Product class V Seasonal energy efficiency value 3%</p> |  <p>Dimensioni (H x W x D) mm 80 x 80 x 23</p> | 3.020167 |
|--|---|----------|

↘ CRONO 7

| | | |
|---|---|----------|
| <p>Weekly digital chronothermostat</p> <p>Product class I* o IV Seasonal energy efficiency value 1%* o 2%</p> |  <p>Dimensions (H x W x D) mm 103 x 142 x 31</p> | 3.021622 |
|---|---|----------|

↘ CRONO 7 WIRELESS

| | | |
|--|---|----------|
| <p>Wireless weekly digital chronothermostat</p> <p>Product class I* o IV Seasonal energy efficiency value 1%* o 2%</p> |  <p>Dimensions (H x W x D) mm 103 x 142 x 31</p> <p>Dimensions (H x W x D) mm 82 x 105 x 26</p> | 3.021624 |
|--|---|----------|

↘ EXTERNAL PROBE

| | | |
|---|--|----------|
| <p>Allows at the boiler to functioning at a variable temperature according to the climatic conditions</p> <p>Product class II* Seasonal energy efficiency value 2%*</p> |  | 3.014083 |
|---|--|----------|

* Product class with default settings. Some heat regulation device can change class depending on the settings and operation modes that can be changed, for example Modulating or ON/OFF, The use of these devices contributes, in percentage, to the seasonal energy efficiency of the heating system.

TELEPHONIC CONTROL

| Type | | | Code |
|--|---|---|----------|
| For buildings equipped with telephone network. Available for all models except MINI CRD |  | Dimensions (H x W x D) mm 85 x 85 x 31 | 3.013305 |

GSM TELEPHONIC CONTROL

| | | | |
|--|---|--|----------|
| For buildings not equipped with telephone network. Available for all models except Mini CRD |  | Dimensions (H x W x D) mm 198 x 78 x 30,5 | 3.017182 |
|--|---|--|----------|

RELAY BOARD KIT

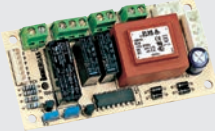
| | | | |
|---|--|--|----------|
| Allows interface between zone valves and CAR, to send an alarm signal, to manage external pump etc. |  | | 3.015350 |
|---|--|--|----------|

CONTROL BOX

| | | | |
|---|--|--|----------|
| Control box for pumps and zone (maximum three) |  | | 3.011668 |
|---|--|--|----------|

SAFETY THERMOSTAT KIT

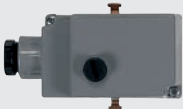
| | | | |
|-------------------------------------|--|--|----------|
| For low temperature system delivery |  | | 3.019229 |
|-------------------------------------|--|--|----------|

DOMINUS INTERFACE BOARD KIT **PREVIEW**

| | | | |
|---|--|--|----------|
| To remote control boiler with DOMINUS APP (Available by december 2015) | | | 3.026273 |
|---|--|--|----------|



OPTIONAL

Inside the various range of options it is possible to find out complementary accessories for installing VICTRIX EXA ErP. The use of original kits enhances quality and reliability of the products.



▶ MAGNETIC CYCLONE FILTER KIT

| Type | | Code |
|--|--|----------|
| <p>Important in case of boiler replacement in order to restrain possible ferrous.</p> <p>Easy to inspect and clean, since the system emptying is not needed. Only for indoor installation.</p> |  | 3.024176 |

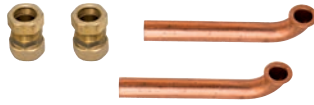
▶ CONNECTION KIT

| | | |
|---|--|----------|
| <p>Connection kit for combi models</p> |  | 3.019264 |
| <p>Connection kit for "X" model for heating only</p> |  | 3.024907 |
| <p>Storage tank connection kit for "X" model (in combination with connection kit code 3.024907)</p> |  | 3.024609 |

▶ SHUT OFF KNOBS

| | | |
|------------------------------------|--|----------|
| <p>Shut off knobs 3/4"</p> |  | 3.5324 |
| <p>Shut off knobs with filters</p> |  | 3.015854 |

▶ ALL PURPOSE CONNECTION KIT

| | | |
|-----------------------------|--|----------|
| <p>For wall hung boiler</p> |  | 3.011667 |
|-----------------------------|--|----------|

ANTISCALE KIT

| Type | | Code |
|---|--|----------|
| For combi boiler only. Approved for installation inside the building |  | 3.017323 |

NON RETURN VALVE KIT

| | | |
|-----------------------|--|----------|
| For combi boiler only |  | 3.016301 |
|-----------------------|--|----------|

ADDITIONAL EXPANSION VESSEL

| | | |
|--------------------------|---|----------|
| 2 litre expansion vessel |  | 3.017514 |
|--------------------------|---|----------|

CONDENSATE DISCHARGE PUMP KIT **PREVIEW**

| | | |
|---|--|----------|
| Usefull in case of counterslope between siphone and discharge; installation externaly to the boiler (Available by december 2015) | | 3.026374 |
|---|--|----------|

ANTI-FREEZE PROTECTION KIT

| | | |
|--------------|--|----------|
| Until -15 °C |  | 3.017324 |
|--------------|--|----------|

COVER KIT

| | | |
|---|--|----------|
| For external installations, in partially protected places |  | 3.026010 |
|---|--|----------|

VICTRIX EXA ErP can be connected to the DIM Range (Multysystem distribution manifolds).





immergas.com

Immergas S.p.A.
42041 Brescello (RE) - Italy
T. 0522.689011
F. 0522.689178



IMMERGAS
IMMERGAS SPA - ITALY
CERTIFIED COMPANY
UNI EN ISO 9001:2008

Design, manufacture and post-sale assistance of gas boilers, gas water heaters and related accessories