



NEW

MAGIS HERCULES MINI HYDRO

Monobloc floor standing heat pumps
with DHW storage tank

Compact solution "all-in-one",
maximum DHW comfort and
installation without F-Gas
license.



MAGIS HERCULES MINI HYDRO

Full Electric without F-Gas license

Full Electric is a market segment with growth prospects in the near future. MAGIS HERCULES MINI HYDRO is a range of **air-water heat pumps** composed of an external monobloc heat pump of 5, 8 or 12 kW and an internal floor standing unit with all you need to heat, cool and produce domestic hot water.

The 180-litre stainless steel storage tank and its electric heater as standard allow **high DHW performance**. The 25-litre stainless steel buffer tank, important for the correct functioning of the heat pump, simplify the installation and optimize costs.

MAGIS HERCULES MINI HYDRO **can be installed without F-Gas license**. Thanks to **small size** and front access of internal unit, **it can be placed in narrow spaces**.

Full electric Immergas solutions are suitable for new homes with zero energy impact, but also in renovations and in buildings with thermal insulations and photovoltaic systems. The best for those who want to minimize waste, save energy and lower costs harmful emissions as much as possible in line with European standards



Renewable
energy



Less
consumptions



More valuable
houses



NEW COMPACT FULL ELECTRIC SOLUTION

MAGIS HERCULES MINI HYDRO is the new compact heat pump designed to reach the highest energy classes in new buildings and renovations of medium-sized homes such as terraced houses. It is available in three single-phase models of 5, 8 and 12 kW and one three-phase model of 12 kW ("EH" versions are with 3 kW system electric heater as standard). All with R32 refrigerant gas.

"ALL IN ONE" FOR HIGH PERFORMANCE

MAGIS HERCULES MINI HYDRO is all-in-one because it combines in the same casing **the stainless steel 180-litre storage tank** with the **2.3 kW electric heater** for domestic hot water and the **stainless steel 25-litre buffer tank** for the operation of the heat pump. In EH versions the **3 kW system electric resistance** is as standard.

EASY CONNECTION

The refrigeration circuit is hermetically sealed and fully integrated into the external unit. The connections between the external and internal units are water-based and do not require F-Gas license.

MAXIMUM SAVINGS WITH PHOTOVOLTAICS

The range is **designed to combine in the most effective way with photovoltaic systems** and thus obtain domestic hot water, heating and cooling with free energy from the sun.





INTERNAL UNIT

180-litre stainless steel DHW storage tank

1 direct zone as standard

25-liter stainless steel buffer tank pre-arranged for insertion of 3 kW system electric heater (as standard for EH versions)

2.3 kW DHW electric heater as standard

10-liter system expansion vessel

2 X 6-liter DHW expansion vessel

3-way diverter valves for managing flows toward the system and DHW storage tank

Flowmeter to detect sufficient circulation on the system

"Y" filter supplied (to be mounted on site)

Indoor **unit protection level IPX5D** (approved for indoor installation only)

EXTERNAL UNIT

Hermetically sealed R32 refrigerant gas circuit

Air finned heat exchanger with single fan in the 5/8 models, double in the 12 models and **Bluefin treatment**

Water/gas (R32) exchanger

Inverter technology rotative compressor

Electronic lamination valve bi-flow

4-way valve for cycle inversion

Heating and cooling operation (reversible)

External unit **protection level IPX4** (approved for installation outdoor without protection)



COMPACTNESS AND EASY INSTALLATION

The remarkable dimensional compactness of the floor standing indoor unit and the hydraulic and refrigerant gas connections placed in the upper part, allow to install **MAGIS HERCULES MINI HYDRO in narrow spaces in width**. The connections to the plants and to the outdoor unit are placed in the top part of the appliance to make **installation simpler and easier**.

In MAGIS HERCULES MINI HYDRO the accessibility is completely frontal.

CONNECTION GROUPS (OPTIONAL)

The pipes bringing connections perfectly aligned to the wall are optional:

- MAGIS HERCULES MINI HYDRO hydraulic connection kit with adjustable by-pass
- MAGIS HERCULES MINI HYDRO hydraulic connection kit (without by-pass it needed a ring always pen on the plant)

Delivery and return solar pipes (inside of the kit thermal solar code 3.033210) are connected to the upper part of the indoor unit too.



USER INTERFACE AND ELECTRONICS

Wide display and user interface. **Illuminated touch keys** with sound effect and encoders to make the adjustments.

From the dashboard it is possible to directly set **numerous electronic functions, including:**

- the time programming of the anti-legionella cycle, the silent mode function (reduction of sound power of the external uni) and the domestic hot water recirculation
- the control of up to 2 system zones (one direct and one mixed hot/cold with kit option)
- the management of an external three-way valve to be able to use different terminals in summer/winter
- the management of dehumidification of one or two zones (with relè kit option)
- DHW BOOST function to use electric heater together with the heat pump to heat storage tank more quickly
- screed drying function

KEY

- | | | | |
|----|---|-----|---------------------------------------|
| 1 | 2 X 6-liter DHW expansion vessel | 12 | 2.3 kW DHW electric heater |
| 2 | 180-litre stainless steel DHW storage tank | 13 | Shut off knob heat pump return |
| 3 | DHW/system diverter valve | 14 | Shut off knob heat pump delivery |
| 4 | Heat pump circulator | | |
| 5 | Flowmeter | R | System return (optional) |
| 6 | 10-liter system expansion vessel | M | System delivery (optional) |
| 7 | 3 kW system electric heater (as standard for EH versions) | AC | Domestic hot water outlet (optional) |
| 8 | 25-liter stainless steel buffer tank | AF | Domestic cold water inlet (optional) |
| 9 | "Y" filter supplied (to be mounted on site) | UCS | Solar exchanger hot output (optional) |
| 10 | Mixing valve (solar kit option) | EFS | Solar exchanger cold input (optional) |
| 11 | DHW recirculation pump (option) | RC | Recirculation (optional) |
| | | RHT | Return to heat pump (optional) |
| | | MHT | Delivery from heat pump (optional) |

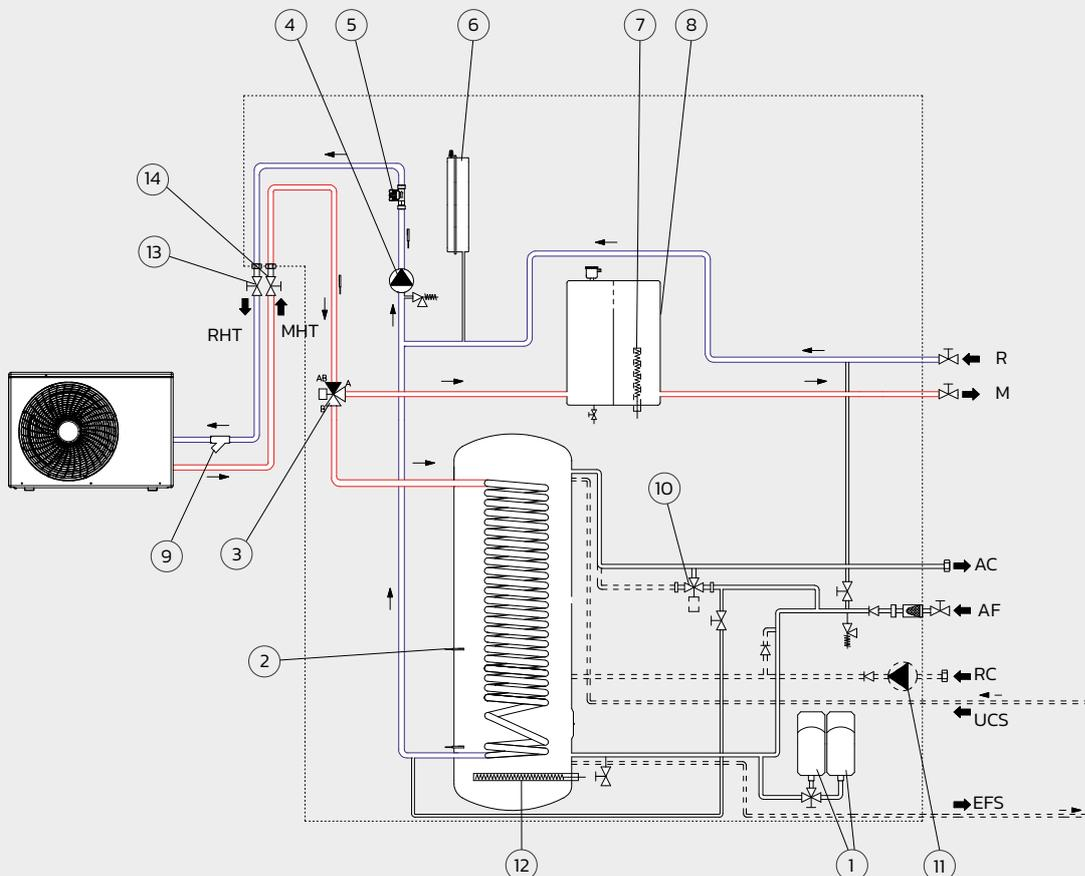

TECHNICAL DATA

Technical characteristics	Unit of measurement	MAGIS HERCULES MINI HYDRO 5	MAGIS HERCULES MINI HYDRO 8	MAGIS HERCULES MINI HYDRO 12
Code		3.035593	3.035594	3.035595
Energetic class in heating at 35 °C		A+++	A+++	A+++
Energetic class in heating at 55 °C		A++	A++	A++
Energetic class DHW/Load profile		A+/L	A/L	A/XL
Refrigerant quantity (R32)	g	1.000	1.150	2.200
Heating capacity (system water 35 °C)	kW	5,00	8,00	12,00
Heating capacity (system water 45 °C)	kW	4,80	7,40	11,70
Heating capacity (system water 55 °C)	kW	4,30	7,10	11,30
Flow temperature range (C.H.)*	°C	20-65	20-65	20-65
COP (system water 35 °C)		4,85	4,52	4,53
COP (system water 45 °C)		3,69	3,49	3,68
COP (system water 55 °C)		2,83	2,81	3,03
Cooling capacity (system water 18 °C)	kW	5,00	7,50	12,00
Cooling capacity (system water 7 °C)	kW	3,90	5,70	9,00
Flow temperature range (cooling)	°C	5 - 25	5 - 25	5 - 25
EER (system water 18 °C)		4,39	3,95	4,33
EER (system water 7 °C)		3,39	3,03	3,30
Heat pump power absorbed**	W	1.030	1.770	2.650
Power supply	V - Hz	230 - 50	230 - 50	230 - 50
Outdoor unit weight (empty)	kg	58,5	76,0	111,0
DATA REFERRED TO INDOOR FLOOR-STANDING UNIT				
Expansion vessel capacity (C.H.)	l	10	10	10
Expansion vessel capacity (D.H.W.)	l	12	12	12
Electric power absorbed	W	150	150	150
Electrical absorption DHW integrative resistance	kW	2,3	2,3	2,3
Max operating pressure system circuit	bar	3	3	3
Max operating pressure DHW circuit	bar	8	8	8
Protection index	IP	X5D	X5D	X5D
D.H.W. temperature range*	°C	10-65	10-65	10-65
Indoor unit weight (empty)	kg	139,7	139,7	139,7

* The maximum values can be reached with the contribution of electric resistances. To know the correlation between delivery temperature and external temperature consult the technical data sheet of the product.

** T system water (D/R) - air (bs/bu) 35/30 °C - 7/6 °C.

Referred to the following conditions:

Environment	Heating (°C)	Cooling (°C)
T system water (D/R) - air (bs/bu)	35/30 - 7/6	18/23 - 35 (bs)
T system water (D/R) - air (bs/bu)	45/40 - 7/6	7/12 - 35 (bs)
T system water (D/R) - air (bs/bu)	55/47 - 7/6	

For more information consult the technical sheet or the website immergas.com



Technical characteristics	Unit of measurement	MAGIS HERCULES MINI HYDRO 5 EH	MAGIS HERCULES MINI HYDRO 8 EH	MAGIS HERCULES MINI HYDRO 12 EH	MAGIS HERCULES MINI HYDRO 12 T EH
Code		3.035596	3.035597	3.035598	3.035599
Energetic class in heating at 35 °C		A+++	A+++	A+++	A+++
Energetic class in heating at 55 °C		A++	A++	A++	A++
Energetic class DHW/Load profile		A+/L	A/L	A/XL	A/XL
Refrigerant quantity (R32)	g	1.000	1.150	2.200	2.200
Heating capacity (system water 35 °C)	kW	5,00	8,00	12,00	12,00
Heating capacity (system water 45 °C)	kW	4,80	7,40	11,70	11,70
Heating capacity (system water 55 °C)	kW	4,30	7,10	11,30	11,30
Flow temperature range (C.H.)*	°C	20–65	20–65	20–65	20–65
COP (system water 35 °C)		4,85	4,52	4,53	4,53
COP (system water 45 °C)		3,69	3,49	3,68	3,68
COP (system water 55 °C)		2,83	2,81	3,03	3,03
Cooling capacity (system water 18 °C)	kW	5,00	7,50	12,00	12,00
Cooling capacity /system water 7 °C)	kW	3,90	5,70	9,00	9,00
Flow temperature range (cooling)	°C	5 – 25	5 – 25	5 – 25	5 – 25
EER (system water 18 °C)		4,39	3,95	4,33	4,33
EER (system water 7 °C)		3,39	3,03	3,30	3,30
Heat pump power absorbed**	W	1030	1770	2.650	2.650
Power supply	V – Hz	230 – 50	230 – 50	230 – 50	380 – 50
Outdoor unit weight (empty)	kg	58,5	76,0	111,0	111,0
DATA REFERRED TO INDOOR FLOOR-STANDING UNIT					
Expansion vessel capacity (CH)	l	10	10	10	10
Expansion vessel capacity (D.H.W.)	l	12	12	12	12
Electric power absorbed	W	150	150	150	150
Electrical absorption CH integrative resistance	kW	3	3	3	3
Electrical absorption DHW integrative resistance	kW	2,3	2,3	2,3	2,3
Max operating pressure system circuit	bar	3	3	3	3
Max operating pressure DHW circuit	bar	8	8	8	8
Protection index	IP	X5D	X5D	X5D	X5D
D.H.W. temperature range*	°C	10–65	10–65	10–65	10–65
Indoor unit weight (empty)	kg	139,7	139,7	139,7	139,7

* The maximum values can be reached with the contribution of electric resistances. To know the correlation between delivery temperature and external temperature consult the technical data sheet of the product.

** T system water (D/R) – aria (bs/bu) 35/30 °C – 7/6 °C.

Referred to the following conditions:

Environment	Heating (°C)	Cooling (°C)
T system water (D/R) – air (bs/bu)	35/30 – 7/6	18/23 – 35 (bs)
T system water (D/R) – air (bs/bu)	45/40 – 7/6	7/12 – 35 (bs)
T system water (D/R) – air (bs/bu)	55/47 – 7/6	

For more information consult the technical sheet or the website immergas.com



MAGIS HERCULES MINI HYDRO

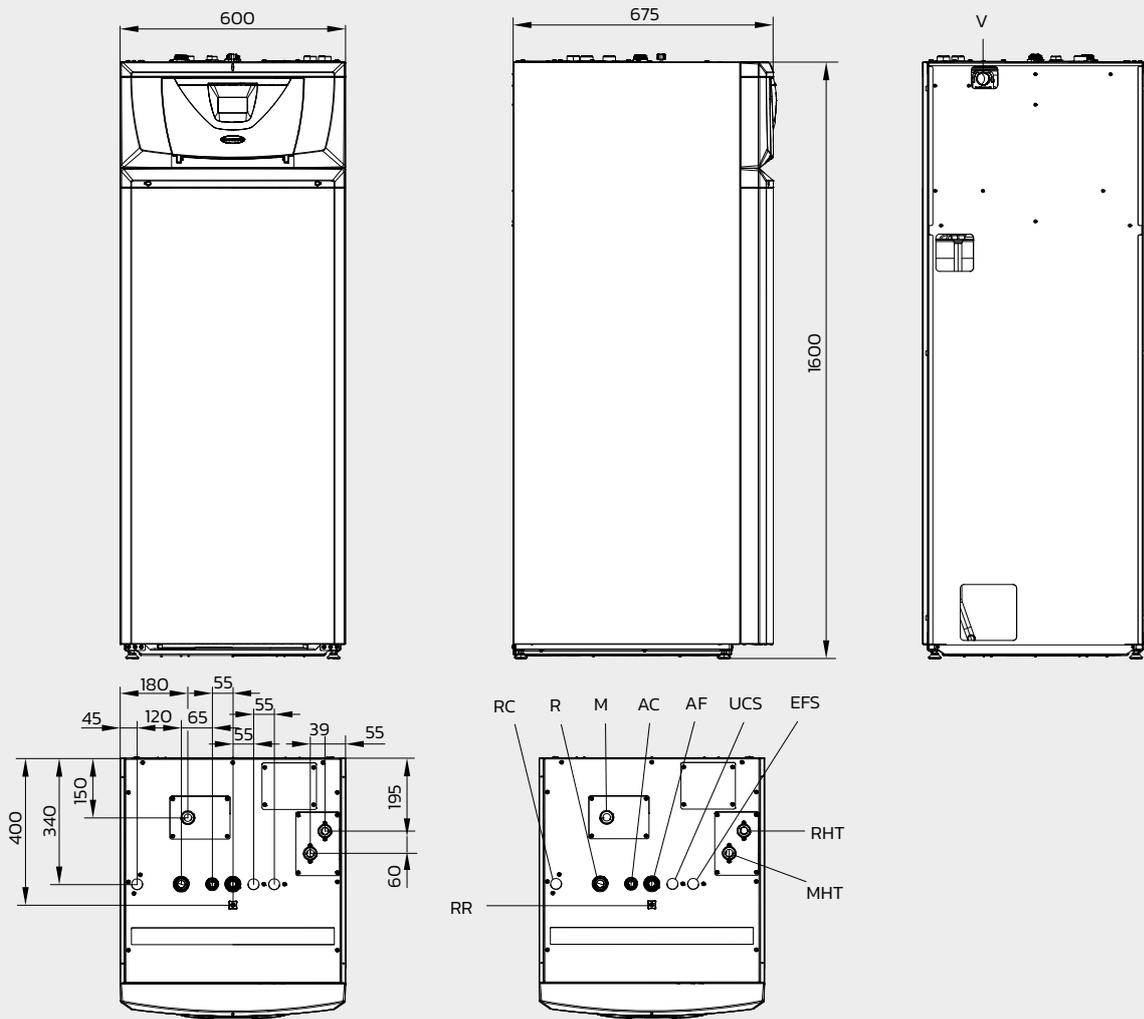

Key

- RHT** Return to heat pump (optional)
- MHT** Delivery from heat pump (optional)
- R** System return (optional)
- M** System delivery (optional)
- AC** Domestic hot water outlet (optional)
- AF** Domestic cold water inlet (optional)
- RC** Recirculation (optional)
- UCS** Solar exchanger hot output (option)
- EFS** Solar exchanger cold input (optional)
- V** Electrical connections
- RR** System filling

Connections MAGIS HERCULES MINI HYDRO

Heat pump	D.H.W.		Recirculation	System	Solar circuit
MHT - RHT	AC	AF	RC	M - R	UCS - EFS
G1"	G3/4"	G3/4"	G3/4"	G1"	G3/4"

MAGIS HERCULES MINI HYDRO 5

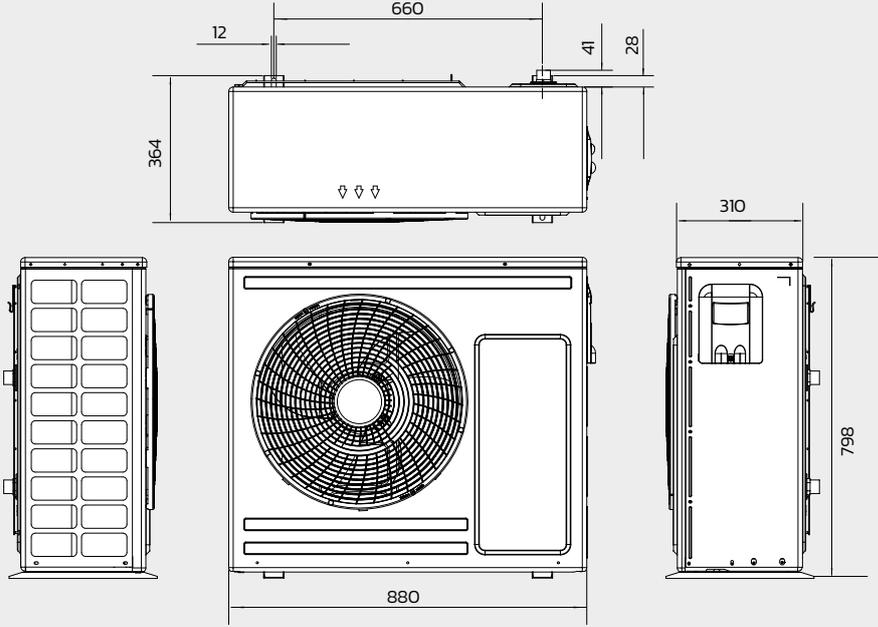

Connections

MHT	RHT
1"	1"

MAGIS HERCULES MINI HYDRO 8

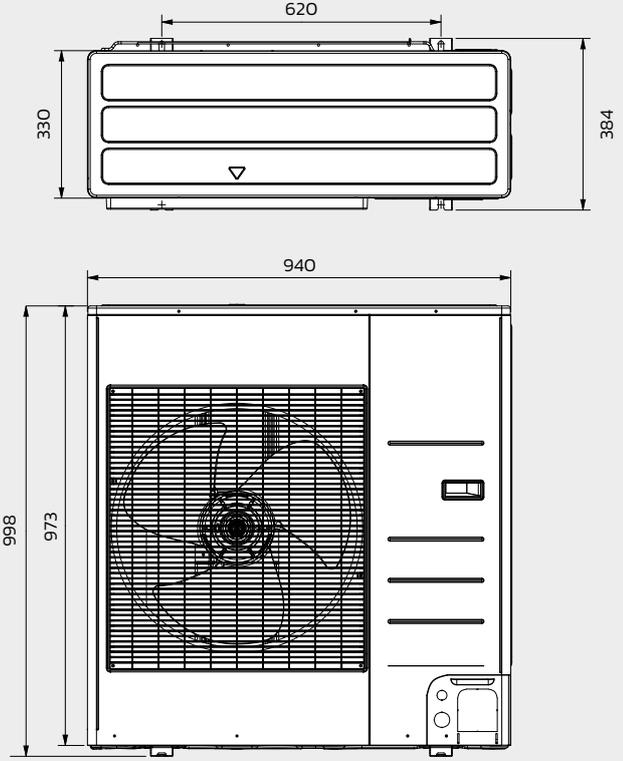

Connections

MHT	RHT
1"	1"

MAGIS HERCULES MINI HYDRO 12

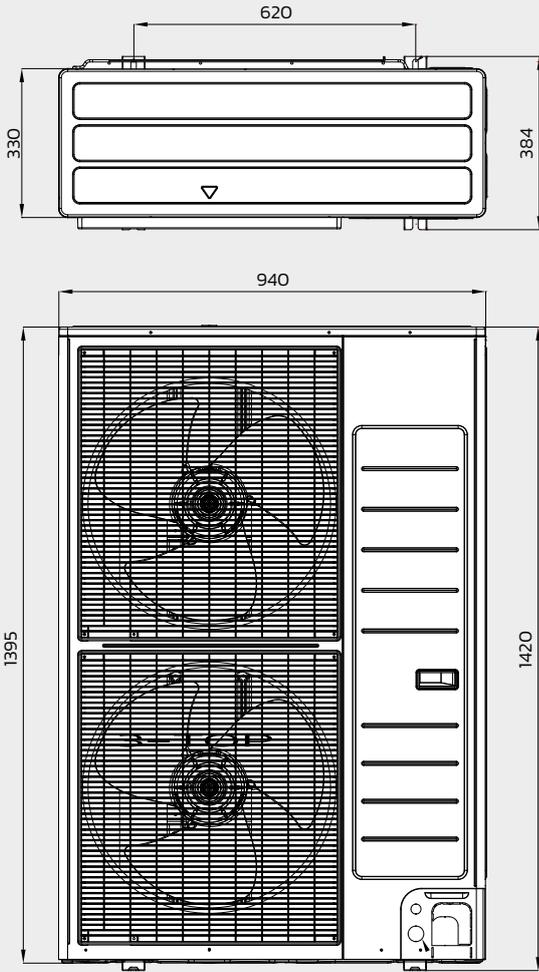

Connections

MHT	RHT
1"	1"

Minimum distances for floor-standing indoor unit

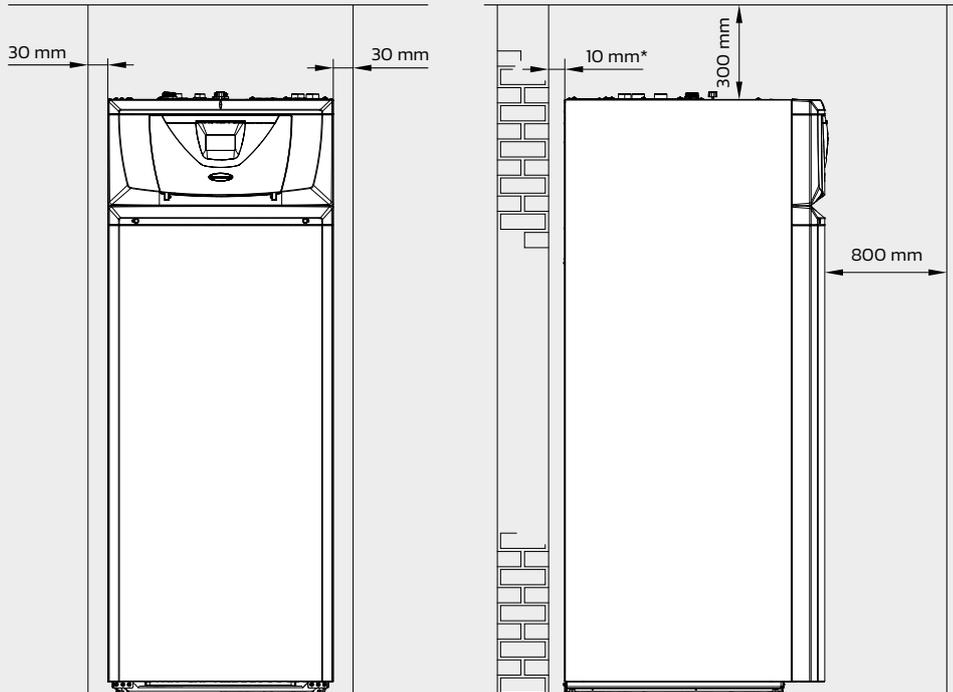

* max 150 mm

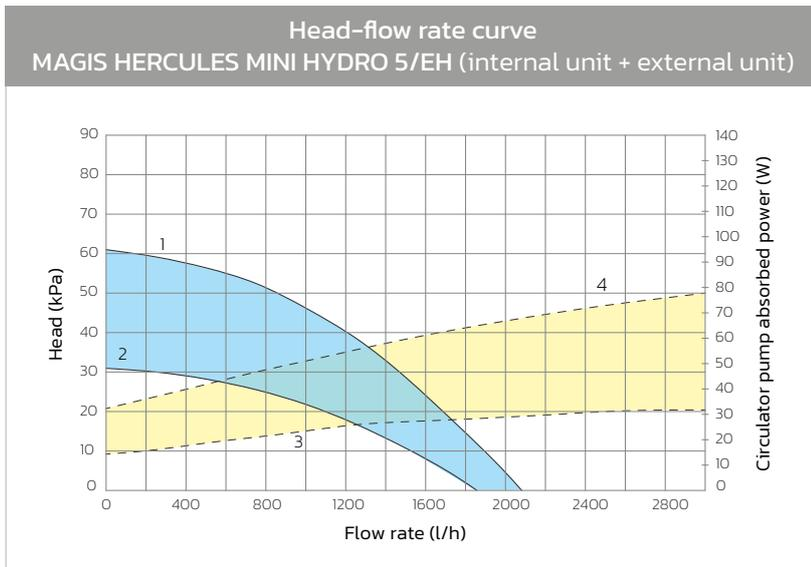

Key

- 1 = Head available to the system PWM 70%
- 2 = Head available to the system PWM 50%
- 3 = Absorbed power by the circulator PWM 50%
- 4 = Absorbed power by the circulator PWM 70%

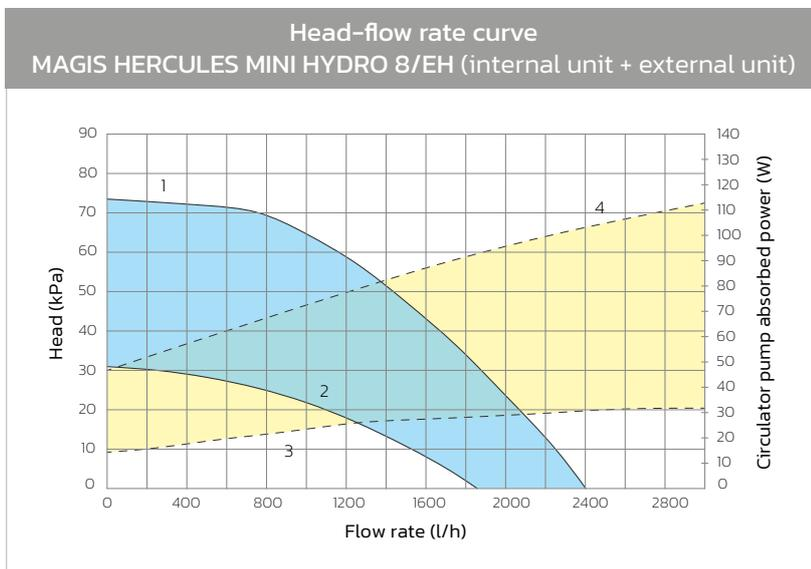

Key

- 1 = Head available to the system PWM 80%
- 2 = Head available to the system PWM 50%
- 3 = Absorbed power by the circulator PWM 50%
- 4 = Absorbed power by the circulator PWM 80%

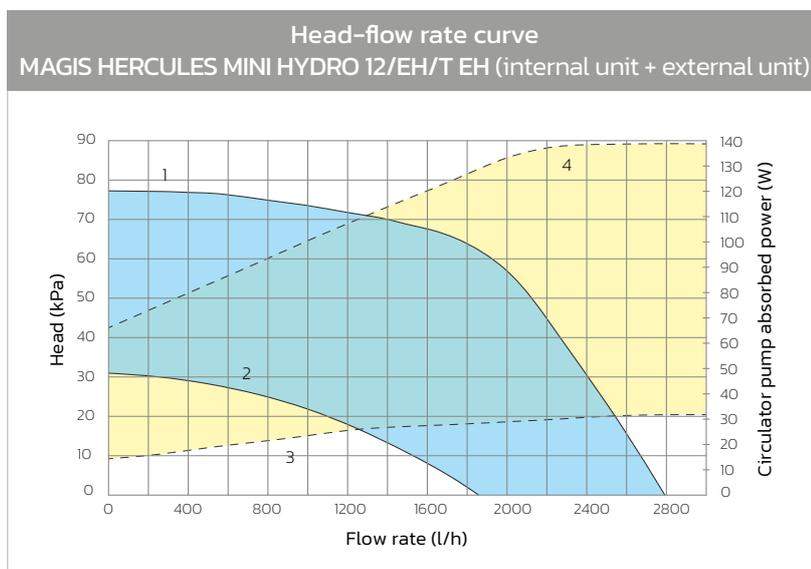

Key

- 1 = Head available to the system PWM 100%
- 2 = Head available to the system PWM 50%
- 3 = Absorbed power by the circulator PWM 50%
- 4 = Absorbed power by the circulator PWM 100%

Technical note: we recommend an installation with a limit distance between the indoor unit and the outdoor unit of 10 meters.



THERMOREGULATION

Combining MAGIS HERCULES MINI HYDRO with a thermoregulation device is an excellent investment because it improves the seasonal energy efficiency of the system.

Remote control panel

Type		Code
Modulating chronothermostat, remote control with temperature/humidity sensor.	 <p>Dimensions (H x W x D) mm 100 x 129 x 37</p>	3.030863

Temperature/humidity active sensor MODBUS kit

To control temperature and humidity.	 <p>Dimensions (H x W x D) mm 80 x 127 x 30</p>	3.030992
--------------------------------------	---	----------

CRONO 7

ON/OFF room thermostat.	 <p>Dimensions (H x W x D) mm 103 x 142 x 31</p>	3.021622
-------------------------	--	----------

WIRELESS version available - code 3.021624.

Room hygrostat

To control humidity.	 <p>Dimensions (H x W x D) mm 70 x 115 x 40</p>	3.023302
----------------------	---	----------

DOMINUS interface kit

Wi-fi interface kit to remote control by app.	 <p>Dimensions (H x W x D) mm 100 x 75 x 45</p>	3.026273
---	--	----------

External probe

To be used when external probe as standard in outdoor unit is not correctly exposed.		3.015266
--	---	----------

Expansion kit

To control temperature system of possible third zone, a diverter valve and for dehumidifier alarm management.		3.031944
---	--	----------

2 relay kit

To manage dehumidifier and/or a diverter valve and recirculation kit.		3.031943
---	---	----------



Within our range it is possible to find a wide option of accessories for the system. The use of original kits ensures quality and reliability of the products.

Connection kit for MAGIS HERCULES MINI HYDRO

Type	Code
Hydraulic connection kit. NEW	3.035068
Hydraulic connection kit with adjustable by-pass. NEW	3.035330
Connection cover kit.	3.034183

System electric heater kit

3 kW integration electric heater (as standard in EH versions).		3.030899
--	--	----------

Recirculation kit with pump

To be combined with 2 relè kit code 3.031943. To be installed inside the casing. Temperature control probe included		3.033217
---	---	----------

Anti-scale kit

To be installed inside the casing.		3.030859
------------------------------------	--	----------

Solar kit

Composed by: plate heat exchanger, single solar pump station (with low consumption circulation pump), solar central unit, shut off knobs, connection pipes, mixing valve, 18 litre solar expansion vessel, temperature probes (for collectors and storage tank). N.B.: For solar panel and other solar accessories see the solar catalogue.		3.033210
	Dimensions (H x W x D) mm 730 x 780 x 300	

3 way diverter valve kit

To be used as diverter valve for heating/cooling switching.		3.020632
---	--	----------



OPTION KITS

Shut off knobs kit

Type		Code
To be used with commercial connection groups. Shut off knobs are standard in the connection group kits for MAGIS HERCULES MINI HYDRO.		3.030860

2 zones kit

For MAGIS HERCULES MINI HYDRO 5-8. 2 heating/cooling zones kit (one direct and one mixed).		3.026301 Dimensions (H x W x D) mm 700 x 450 x 190
For MAGIS HERCULES MINI HYDRO 5-8. 2 direct zones, heating only		3.032264 Dimensions (H x W x D) mm 700 x 450 x 190
For MAGIS HERCULES MINI HYDRO 5-8. 2 zones kit, one direct and one mixed, heating only.		3.032265 Dimensions (H x W x D) mm 700 x 450 x 190
For MAGIS HERCULES MINI HYDRO 12. 2 heating/cooling zones kit (one direct and one mixed).		3.031695 Dimensions (H x W x D) mm 700 x 450 x 190
For MAGIS HERCULES MINI HYDRO 12. NEW 2 zones kit (one direct and one mixed) only heating		3.035333
For MAGIS HERCULES MINI HYDRO 12. NEW 2 direct zones, heating only.		3.035334
Shut off knobs for zones kit.		3.014948



Wall mounting brackets kit

Type	Code
For external unit.	3.034758

Electronic double anode kit

Useful to protect the storage tank from eddy currents.	3.025003
--	----------

Dehumidification

Dehumidifier kit*		3.021529
Dehumidifier back frame kit*		3.022146
Dehumidifier front grille kit*		3.022147

* To be used with radiant systems that also work in cooling mode.

ZENITAIR-MONO

Mechanical bidirectional ventilation unit		3.030601
---	---	----------

External cover kit with acoustical insulation for ZENITAIR-MONO

Anti-insect net and anti-wind in pre-painted steel		3.030636
--	--	----------

MAGIS HERCULES MINI HYDRO can be combined with the fancoil range (wall-hung, floor standing and built-in). For information, consult the documentation which can be downloaded from the website immergas.com



Immergas S.p.a.

42041 Brescello (RE) - Italy

T. 0522.689011



immergas.com



	IMMERGAS IMMERGAS SPA - ITALY CERTIFIED COMPANY UNI EN ISO 9001:2015
Design, manufacture and post-sale assistance of gas boilers, gas water heaters and related accessories	